

1x
Kompl.
Karton

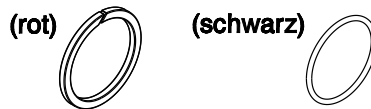

Unbedingt vor Montage kontrollieren!
Roter Sicherungsring und O-Ring müssen auf jedem Anschluss der Füllleitung montiert sein.

1x
Kompl.
Beutel

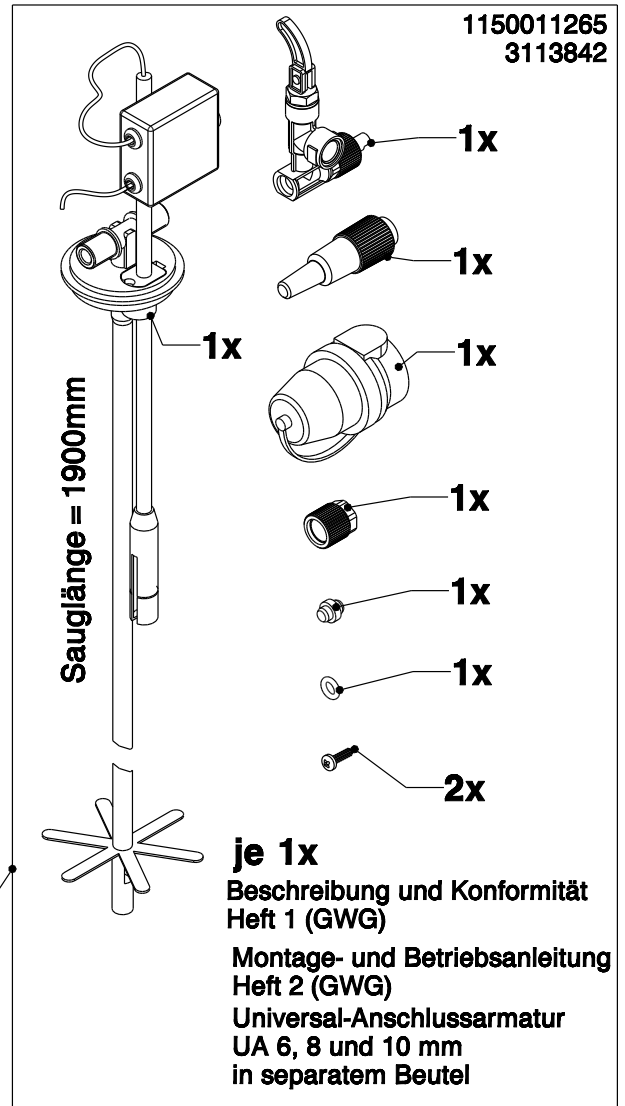

1150011265
3113842

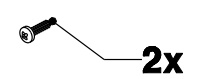
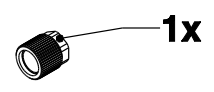
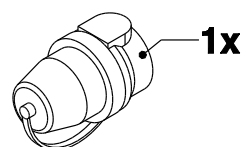
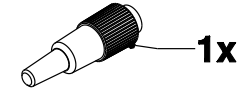
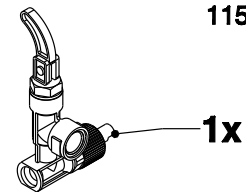

je 1x
Beschreibung und Konformität Heft 1 (GWG)
Montage- und Betriebsanleitung Heft 2 (GWG)
Universal-Anschlussarmatur UA 6, 8 und 10 mm in separatem Beutel

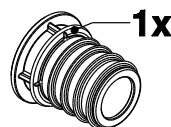
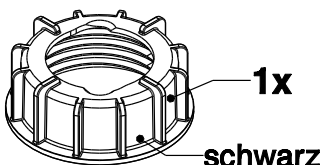
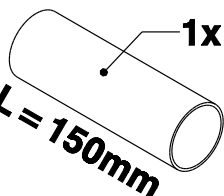
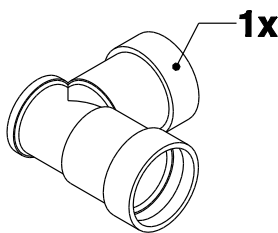

1x
Kompl.
Beutel

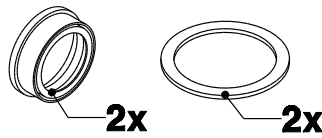

3113917	Übersichtszettel Beutelinhalt Grundeinheit G KWT 750/1000 I-G	1x
3112139	Zulassungsheft A5 Füllstar Z-40.7-487	1x
3114113	Montageanleitung KWT alle Typen, DE F-Stop	1x
3112140	Aufkleber (2 Stück) Zulassung Füllstar Düse 6mm	1x

Kontrollmarke (Seriennummer, Herstelldatum, Prüfer)

* Je nach Aufstellvariante bleiben nach der Montage einige Teile übrig!

XXXXXXXXXX

TT.MM.JJJJ

XXX