













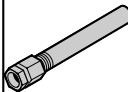

- *Instructions de montage de la visserie pour la ligne gaz et les brides*
 - *Hinweise zur Montage der verschiedenen Kleinteile für Brennergruppe und Flansche*
 - *Instructions for the fitting of the small parts for the gas line and the flanges*

1		M8	6x
2		M8 x 30	6x
3		M8	6x
4		M12	16x
5		M12	16x
6		1/2"	1x
7		3/4"	1x

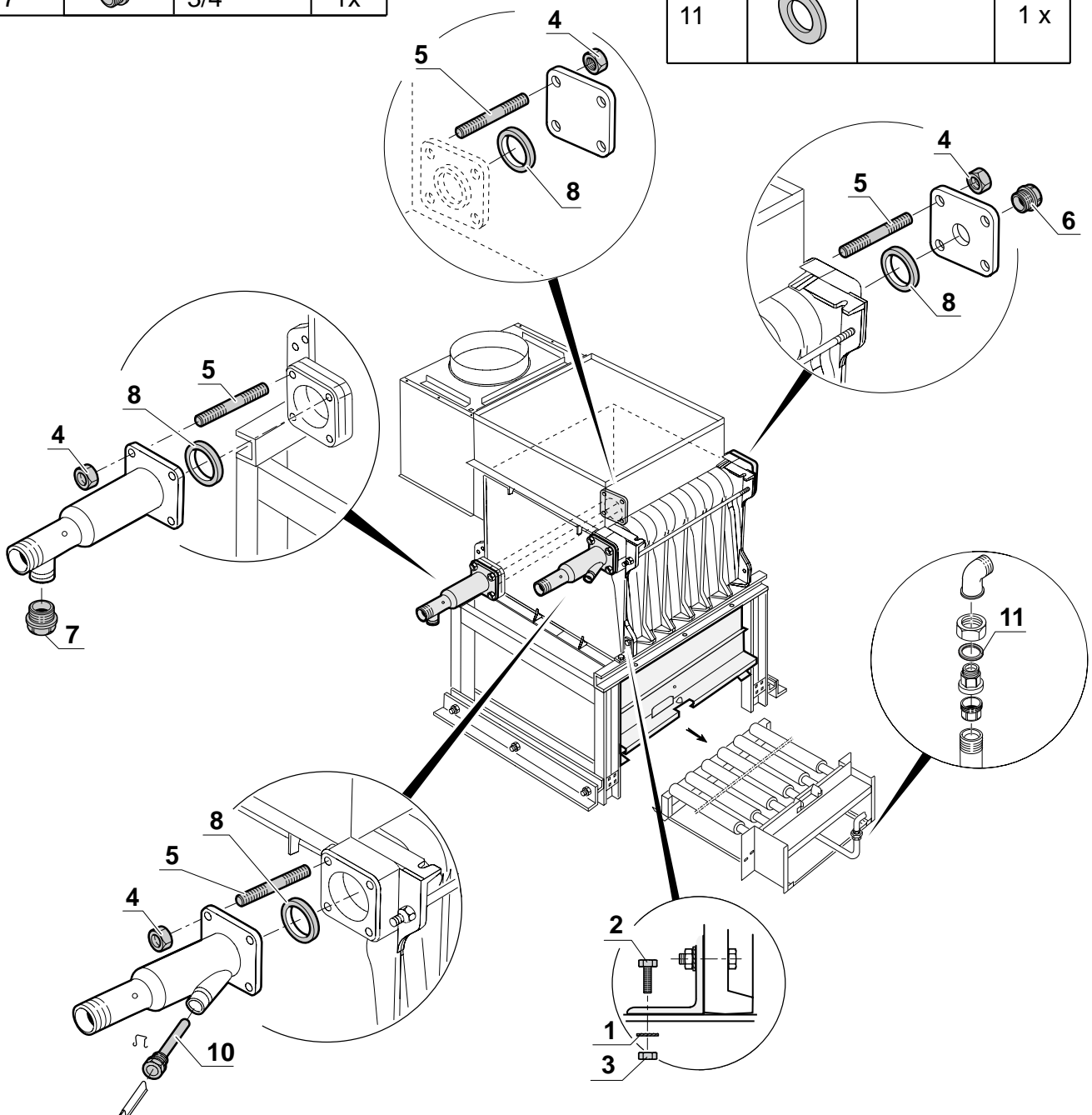
8		96 x 74 x 4	4 x
/		Collier Kabelbinder collar	6 x
10		1/2" Lg 160	1 x
11			1 x





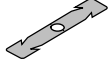
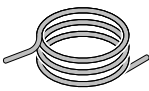

- Instructions de montage de la visserie pour l'antirefouleur
- Hinweise zur Montage der verschiedenen Kleinteile für den Abgassammler
- Instructions for the fitting of the small parts for the draught diverter

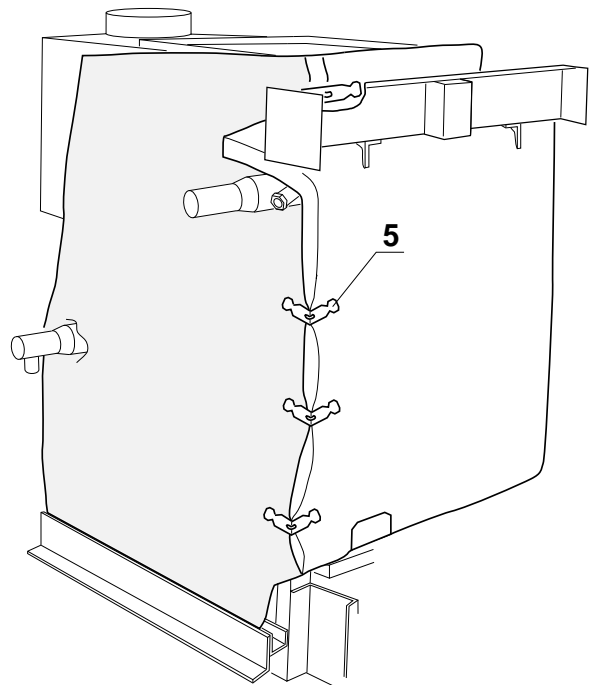
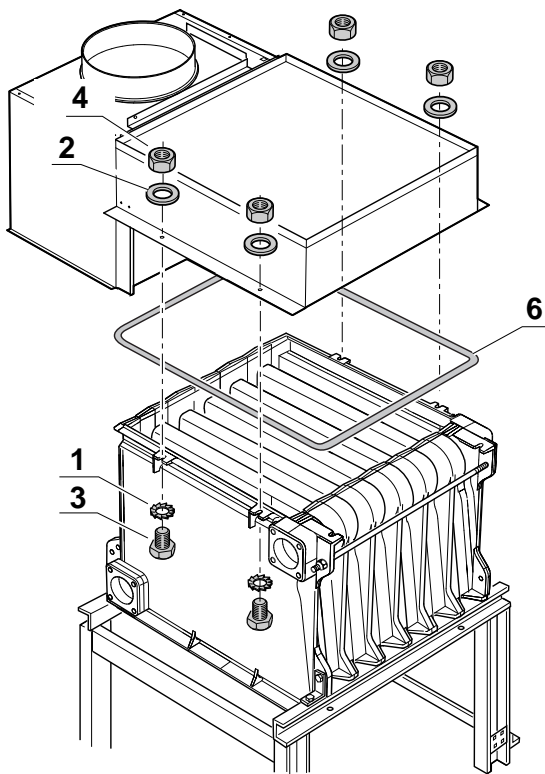



1		M8	4x
2		M8	4x
3		M8 x 30	4x
4		M8	4x

5			25x
6		Adhesif selbstklebend ø10 x 2500	1x







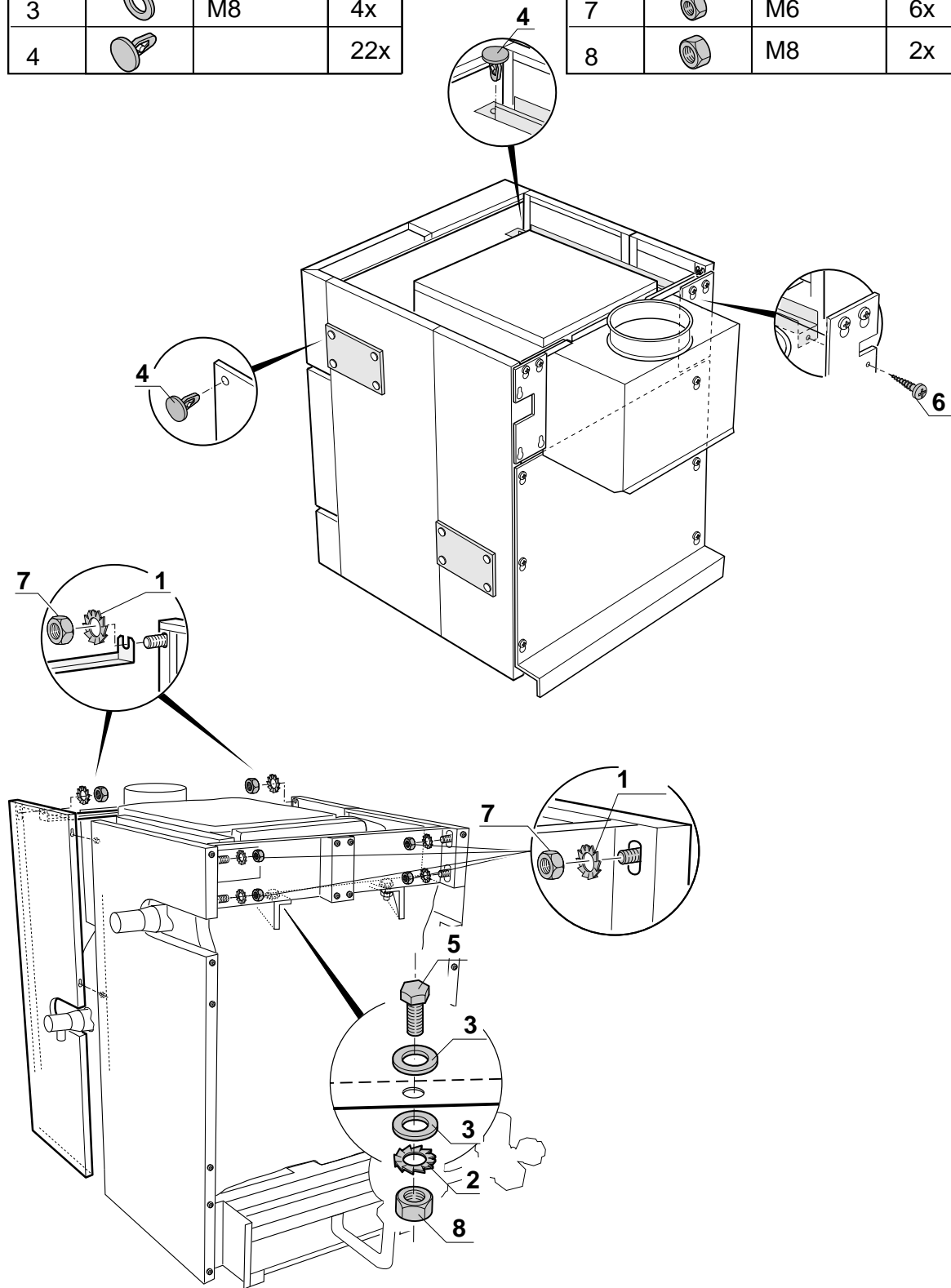

- Instructions de montage de la visserie pour l'habillage
 - Hinweise zur Montage der verschiedenen Kleinteile für die Kesselverkleidung
 - Instructions for the fitting of the small parts for the casing

1		M6	6x
2		M8	2x
3		M8	4x
4			22x

5		M8 x 30	2x
6		3,9 x 6,5	2x
7		M6	6x
8		M8	2x

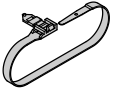

- Instructions de montage de la visserie pour le tableau de commande
- Hinweise zur Montage der verschiedenen Kleinteile für den Schaltkasten
- Instructions for the fitting of the small parts for the control panel

1			1x
2		T 3,15 A	1x
3		Collier Kabelbinder collar	9x
4		Serre-câble Zugentlastung Cable clamp	11x
5		3,5 x 25	22x
6			1x
7			4x

