



Sanpress-Reduziermuffe

- Pressanschlüsse

Ausstattung

Dichtelemente EPDM

Modell 2215.2NC

Artikel 363 437

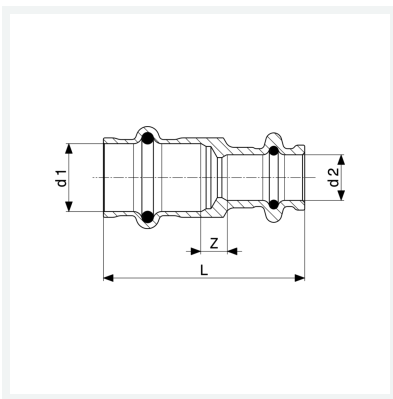

Eigenschaften

Gewicht	63,8 g
Volumen	82,88 cm ³