



Seapress-Bogen 45°

- Pressanschlüsse

Ausstattung

Dichtelemente EPDM

Modell 0326

Artikel 453 886

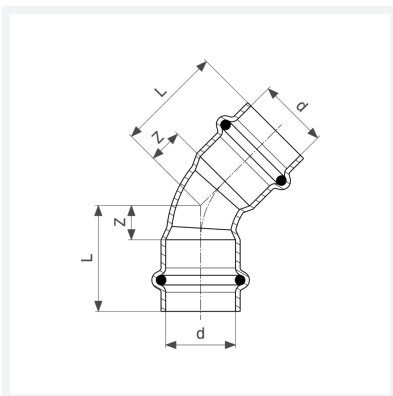

Eigenschaften

Rohraußendurchmesser	d	15
Z-Maß	Z	8 mm
Länge	L	30 mm
Gewicht	37,5 g	
Volumen	62,16 cm ³	
Werkstoff	CuNiFe	