



Seapress XL-Muffe

- Pressanschlüsse

Ausstattung

Dichtelemente EPDM, Schneidringe, Trennringe

Modell 0315XL

Artikel 556 495

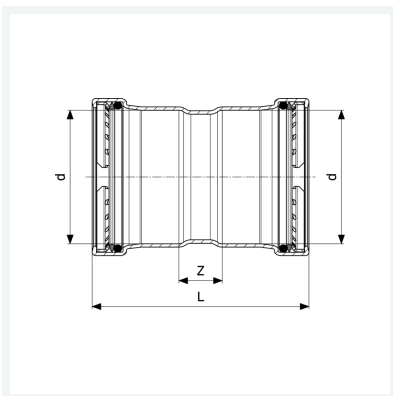

Eigenschaften

Rohraußendurchmesser	d	76,1
Z-Maß	Z	25 mm
Länge	L	125 mm
Gewicht	700 g	
Volumen	1776 cm ³	
Werkstoff	CuNiFe	