



## Seapress XL-Bogen 90°

- Pressanschlüsse

### Ausstattung

Dichtelemente EPDM, Schneidringe, Trennringe

**Modell 0316XL**

**Artikel 556 570**

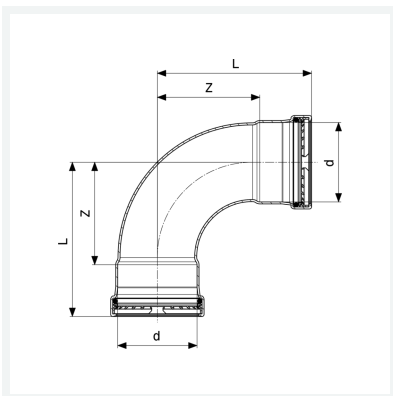

## Eigenschaften

Rohraußendurchmesser	d	76,1
Z-Maß	Z	99 mm
Länge	L	149 mm
Gewicht		1295 g
Volumen		4144 cm <sup>3</sup>
Werkstoff		CuNiFe