

Badewanne - MEM

Wannen-Schwallauslauf ohne Umstellung für Standmontage - platin

Artikelnummer: 13 630 730-08



- Ausladung 240 mm
- Schwall
- Armaturenhöhe 133 mm
- Höhe bis Luftsprudler 120 mm
- Bohrungsdurchmesser 32 mm
- Anschluss 1/2"
- Durchfluss max. 26,5 l/min bei 3 bar Fließdruck

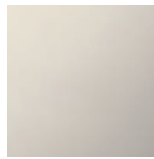

platin

Maßzeichnung

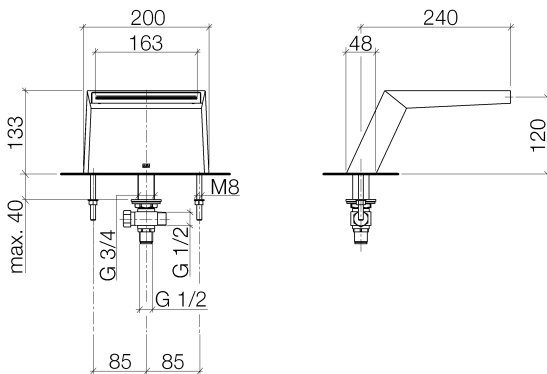

Alle Angaben in mm / inch = mm x 0,0394

Badewanne - MEM

Wannen-Schwallauslauf ohne Umstellung für Standmontage - platin

Artikelnummer: 13 630 730-08

Durchflussdiagramm

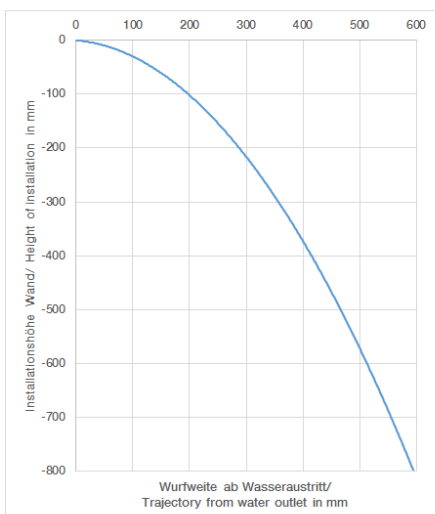
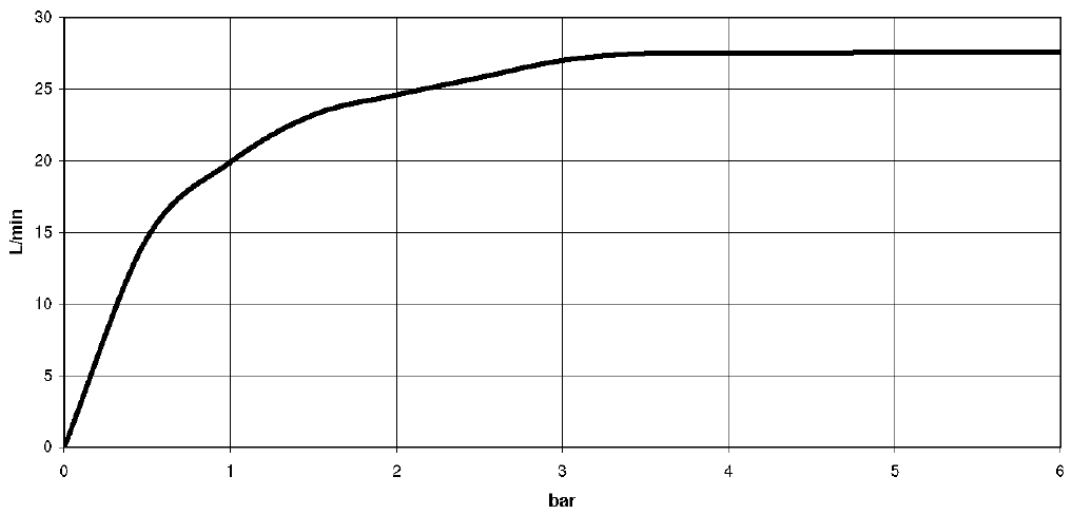

Badewanne - MEM

Wannen-Schwallauslauf ohne Umstellung für Standmontage - platin

Artikelnummer: 13 630 730-08

Weitere Oberflächenvarianten



chrom

13 630 730-00



platin matt

13 630 730-06

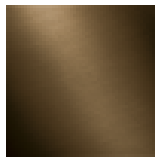

Dark Brass matt

13 630 730-16

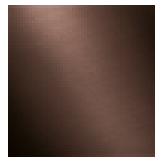

Dark Bronze matt

13 630 730-17



messing gebürstet

13 630 730-28

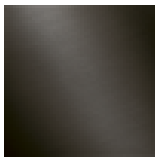

Dark Platin matt

13 630 730-99

Weitere Oberflächen auf Anfrage (x-tra Service)