

















90 11 06 212 01 Produktversion von 01.04.2025 bis 15.05.2020



	Chrom	90 11 06 212 01-00
	Platin gebürstet	90 11 06 212 01-06
	Platin	90 11 06 212 01-08
	Dark Chrome	90 11 06 212 01-19
	Light Gold (PVD)	90 11 06 212 01-26
	Light Gold gebürstet (PVD)	90 11 06 212 01-27
	Messing gebürstet (23kt Gold)	90 11 06 212 01-28
	Schwarz matt	90 11 06 212 01-33
	Dark Brass gebürstet (PVD)	90 11 06 212 01-39
	Bronze gebürstet (PVD)	90 11 06 212 01-42
	Champagne gebürstet (22kt Gold)	90 11 06 212 01-46
	Champagne (22kt Gold)	90 11 06 212 01-47
	Zartgrün	90 11 06 212 01-54
	Hellrosa	90 11 06 212 01-55
	Graublau	90 11 06 212 01-61
	Hellgrau	90 11 06 212 01-63
	Dunkelgrau	90 11 06 212 01-66



Auslauf 90 x 145 x 35 mm, 4,54 l/min. - Chrom

ERSATZTEILE

90 11 06 212 01 Produktversion von 01.04.2025 bis 15.05.2020



Auslauf 90 x 145 x 35 mm, 4,54 l/min. - Chrom

ERSATZTEILE

90 11 06 212 01 Produktversion von 01.04.2025 bis 15.05.2020

90 11 06 212 01 Produktversion von 01.04.2025 bis 15.05.2020

Ersatzteile für die
anderen
Oberflächenvarianten
finden Sie hier: Platin
gebürstet

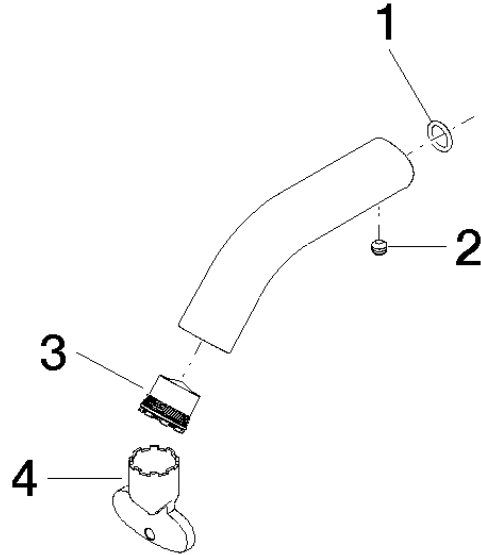

Ersatzteilstückliste

Nr.	Artikelnummer	Benennung	Verbaumenge	Lieferzeit
3	09 29 03 125 90	Luftsprudlereinsatz pink, 1.2 gpm -	1,00	2
2	90 31 11 063 00 90	Befestigung Gewindestift mit Innensechskant mit Ringschneide M5 x 4 mm -	1,00	2
1	90 14 10 060 00 90	O-Ring 8,0 x 1,5 mm -	1,00	2
4	90 30 09 028 00 90	Montageschlüssel -	1,00	2