









90 12 08 020 00



	Platin	90 12 08 020 00-08
	Chrom	90 12 08 020 00-00
	Platin gebürstet	90 12 08 020 00-06
	Dark Chrome	90 12 08 020 00-19
	Messing gebürstet (23kt Gold)	90 12 08 020 00-28
	Bronze gebürstet	90 12 08 020 00-42
	Chrom gebürstet	90 12 08 020 00-93
	Dark Platin gebürstet	90 12 08 020 00-99



Luftsprudler Kopfstück Ø 26 x 32 mm, 8 l/min. - Platin

ERSATZTEILE

90 12 08 020 00



Luftsprudler Kopfstück Ø 26 x 32 mm, 8 l/min. - Platin

ERSATZTEILE

90 12 08 020 00

90 12 08 020 00

Ersatzteile für die
anderen
Oberflächenvarianten
finden Sie hier:
Chrom

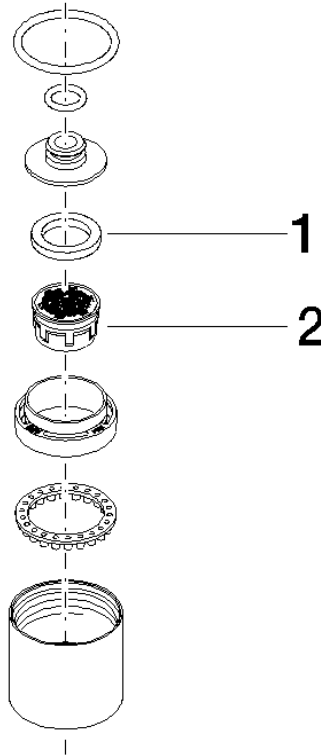

Ersatzteilstückliste

Nr.	Artikelnummer	Benennung	Verbaumenge	Lieferzeit
1	09 14 05 002 90	Dichtung NBR 70 21,3 x 15 x 2,8 mm -	1,00	2
2	09 29 03 051 90	Luftsprudlereinsatz M22/M24 8,0 l/min. -	1,00	2