

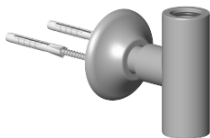











90 17 11 033 00



	Dark Platinum gebürstet	90 17 11 033 00-99
	Chrom	90 17 11 033 00-00
	Gold (23,9kt)	90 17 11 033 00-01
	Platin gebürstet	90 17 11 033 00-06
	Platin	90 17 11 033 00-08
	Messing (23kt Gold)	90 17 11 033 00-09
	Dark Brass matt	90 17 11 033 00-16
	Dark Bronze matt	90 17 11 033 00-17
	Messing gebürstet (23kt Gold)	90 17 11 033 00-28
	Dark Brass gebürstet	90 17 11 033 00-39
	Bronze gebürstet	90 17 11 033 00-42



Befestigung T-Stück 135 x 150 x 85 mm - Dark Platinum gebürstet

ERSATZTEILE

90 17 11 033 00



Befestigung T-Stück 135 x 150 x 85 mm - Dark Platinum gebürstet

ERSATZTEILE

90 17 11 033 00

90 17 11 033 00

Ersatzteile für die
anderen
Oberflächenvarianten
finden Sie hier:
Chrom

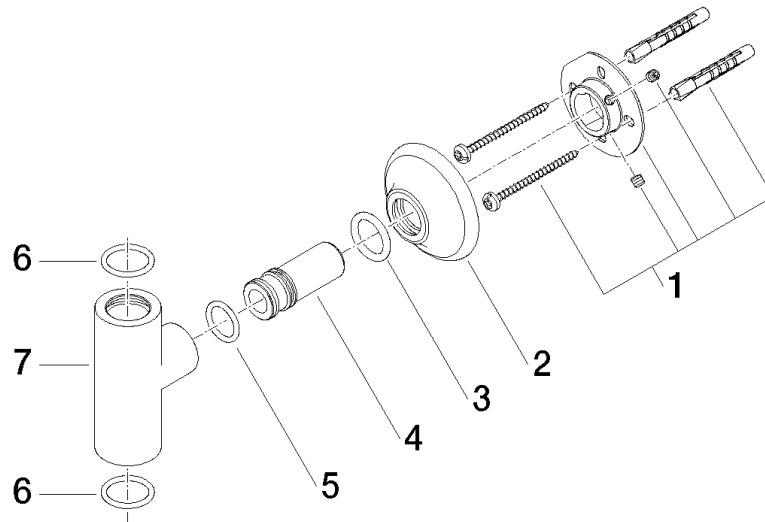

Ersatzteilstückliste

Nr.	Artikelnummer	Benennung	Verbaumenge	Lieferzeit
3	09 14 10 006 90	O-Ring 18,0 x 3,5 mm -	1,00	2
7	09 17 11 033-99	Anschluss für Standbrause T-Stück 31 x 50 x 80 mm - Dark Platinum gebürstet	1,00	20
4	09 17 97 052-99	Halter für Brausebatterie Madison Ø 20 x 49 mm - Dark Platinum gebürstet	1,00	20
2	09 27 36 021-99	Rosette Ø 60 x 18 mm - Dark Platinum gebürstet	1,00	20
5	09 14 10 022 90	O-Ring EPDM 70 16,0 x 2,5 mm -	1,00	2
1	05 17 20 707 02 90	Befestigungssatz rund Ø 54 x 90 mm -	1,00	2
6	09 14 10 100 90	O-Ring EPDM 70 20,0 x 2,5 mm -	2,00	2