

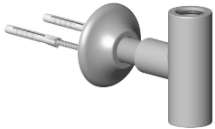











90 17 11 037 01



	Chrom	90 17 11 037 01-00
	Gold (23,9kt)	90 17 11 037 01-01
	Platin gebürstet	90 17 11 037 01-06
	Platin	90 17 11 037 01-08
	Messing (23kt Gold)	90 17 11 037 01-09
	Dark Brass matt	90 17 11 037 01-16
	Dark Bronze matt	90 17 11 037 01-17
	Messing gebürstet (23kt Gold)	90 17 11 037 01-28
	Dark Brass gebürstet	90 17 11 037 01-39
	chrom satin	90 17 11 037 01-41
	Bronze gebürstet	90 17 11 037 01-42
	Dark Platinum gebürstet	90 17 11 037 01-99



Befestigung für Brause Stand T-Stück - Chrom

ERSATZTEILE

90 17 11 037 01



Befestigung für Brause Stand T-Stück - Chrom

ERSATZTEILE

90 17 11 037 01

90 17 11 037 01

Ersatzteile für die
anderen
Oberflächenvarianten
finden Sie hier: Gold
(23,9kt)

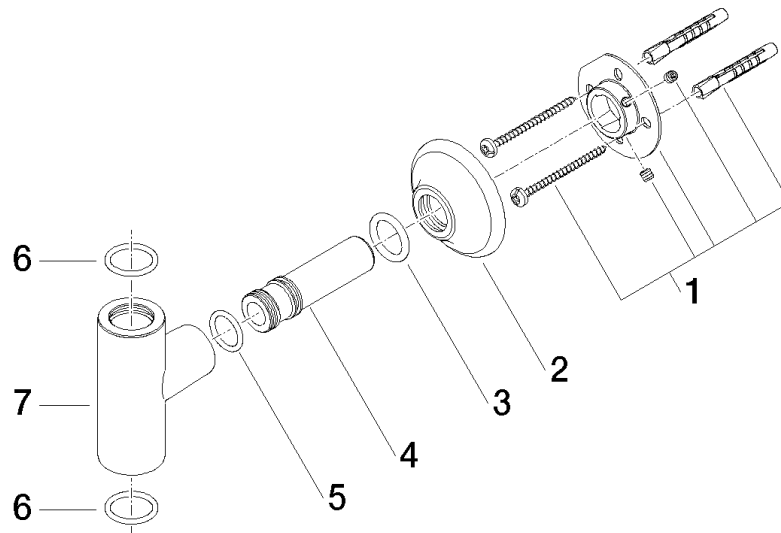

Ersatzteilstückliste

Nr.	Artikelnummer	Benennung	Verbaumenge	Lieferzeit
7	09 17 11 037-00	Anschluss für Standbrause T-Stück 31 x 59 x 80 mm - Chrom	1,00	10
5	09 14 10 022 90	O-Ring EPDM 70 16,0 x 2,5 mm -	1,00	2
1	05 17 20 707 02 90	Befestigungssatz rund Ø 54 x 90 mm -	1,00	2
3	09 14 10 006 90	O-Ring 18,0 x 3,5 mm -	1,00	2
2	09 27 36 021-00	Rosette Ø 60 x 18 mm - Chrom	1,00	10
4	09 17 97 050-00	Halter für T-Stück Ø 20 x 70 mm - Chrom	1,00	10
6	09 14 10 100 90	O-Ring EPDM 70 20,0 x 2,5 mm -	2,00	2