















90 28 22 172 00



	Chrom	90 28 22 172 00-00
	Platin gebürstet	90 28 22 172 00-06
	Platin	90 28 22 172 00-08
	Messing (23kt Gold)	90 28 22 172 00-09
	Dark Brass matt	90 28 22 172 00-16
	Dark Bronze matt	90 28 22 172 00-17
	Dark Chrome	90 28 22 172 00-19
	Light Gold gebürstet	90 28 22 172 00-27
	Messing gebürstet (23kt Gold)	90 28 22 172 00-28
	Dark Brass gebürstet	90 28 22 172 00-39
	Bronze gebürstet	90 28 22 172 00-42
	Champagne gebürstet (22kt Gold)	90 28 22 172 00-46
	Champagne (22kt Gold)	90 28 22 172 00-47
	Cyprum	90 28 22 172 00-49
	Dark Platin gebürstet	90 28 22 172 00-99



Auslauf 35 x 11 x 220 mm - Chrom

ERSATZTEILE

90 28 22 172 00



Auslauf 35 x 11 x 220 mm - Chrom

ERSATZTEILE

90 28 22 172 00

90 28 22 172 00

Ersatzteile für die  
anderen  
Oberflächenvarianten  
finden Sie hier: Platin  
gebürstet

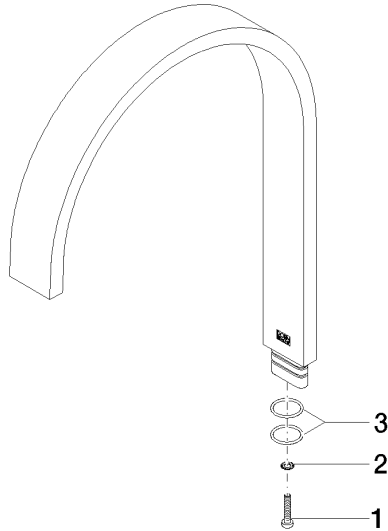

**Ersatzteilstückliste**

Nr.	Artikelnummer	Benennung	Verbaumenge	Lieferzeit
3	09 14 10 096 90	O-Ring EPDM 70 17,0 x 1,5 mm -	2,00	2
2	09 30 11 028 90	Befestigung Fächerscheibe Ø 4,3 -	1,00	2
1	90 30 30 075 00 90	Befestigung Zylinderschraube mit Innensechskant niedriger Kopf M4 x 20 mm -	1,00	2