













90 28 22 265 00



	Cyprum	90 28 22 265 00-49
	Chrom	90 28 22 265 00-00
	Platin gebürstet	90 28 22 265 00-06
	Platin	90 28 22 265 00-08
	Dark Brass matt	90 28 22 265 00-16
	Dark Bronze matt	90 28 22 265 00-17
	Dark Chrome	90 28 22 265 00-19
	Light Gold gebürstet	90 28 22 265 00-27
	Messing gebürstet (23kt Gold)	90 28 22 265 00-28
	Bronze gebürstet	90 28 22 265 00-42
	Champagne gebürstet (22kt Gold)	90 28 22 265 00-46
	Champagne (22kt Gold)	90 28 22 265 00-47
	Dark Platinum gebürstet	90 28 22 265 00-99



Auslauf 35 x 125 x 128 mm - Cyprum

ERSATZTEILE

90 28 22 265 00



Auslauf 35 x 125 x 128 mm - Cyprum

ERSATZTEILE

90 28 22 265 00

90 28 22 265 00

Ersatzteile für die
anderen
Oberflächenvarianten
finden Sie hier:
Chrom

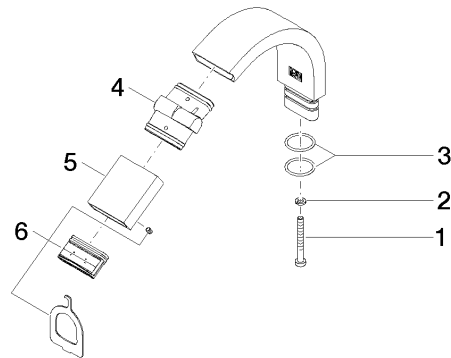

Ersatzteilstückliste

Nr.	Artikelnummer	Benennung	Verbaumenge	Lieferzeit
3	09 14 10 096 90	O-Ring EPDM 70 17,0 x 1,5 mm -	2,00	2
6	90 29 03 045 00 90	Luftsprudlereinsatz ohne Begrenzung 32 x 8 mm -	1,00	2
5	09 23 01 157-49	Luftsprudlerhülse 35 x 38,5 x 11 mm - Cyprum	1,00	-
Ersatzteil nicht mehr bestellbar, bitte bestellen Sie den Nachfolgeartikel				
1	09 30 30 097 90	Befestigung Zylinderschraube mit Innensechskant niedriger Kopf M4 x 35 mm -	1,00	2
2	90 30 11 029 00 90	Anschluss Federring Ø 4 -	1,00	2
4	90 24 02 103 00-49	Gelenk für Bidet 35 x 30 x 38 mm - Cyprum	1,00	30