

INSTALLATION MANUAL

MONTAGEANLEITUNG
INSTRUCTIONS DE MONTAGE
ISTRUZIONI PER IL MONTAGGIO

**KNOW
HOW
INSTALLED**

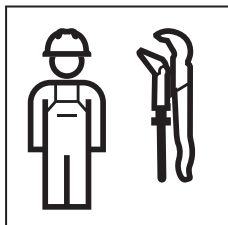



1

1

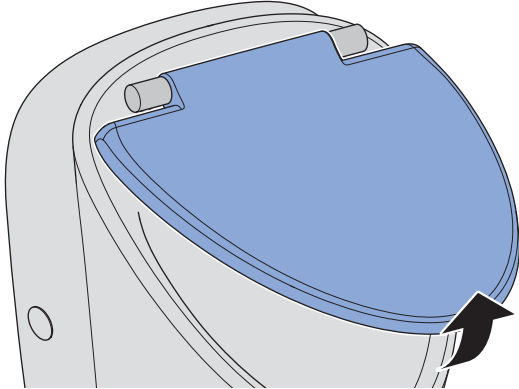

2

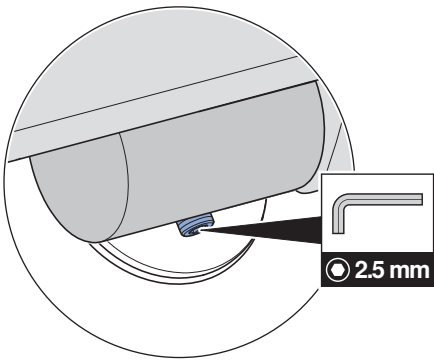
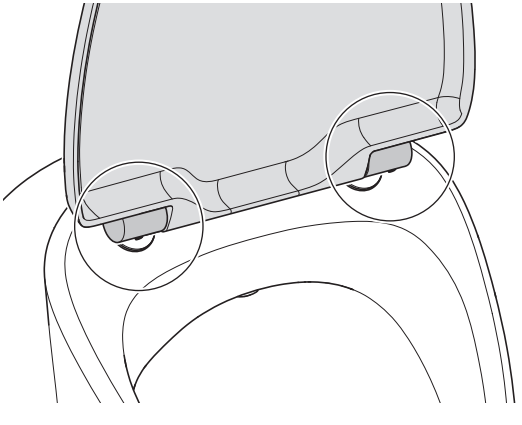

3

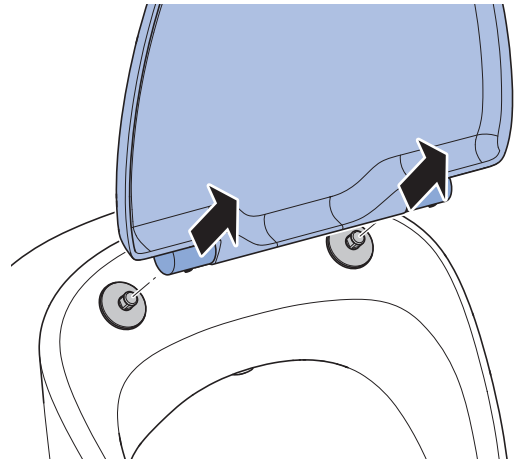

4

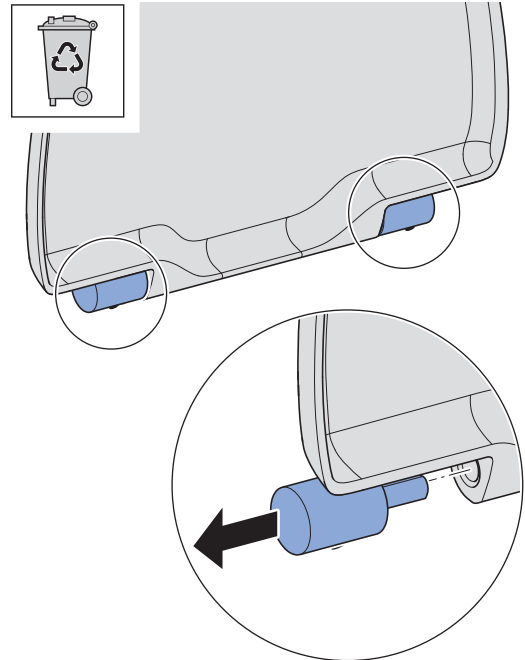

5

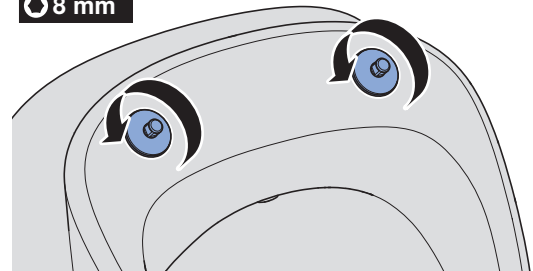
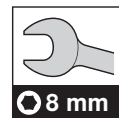

6

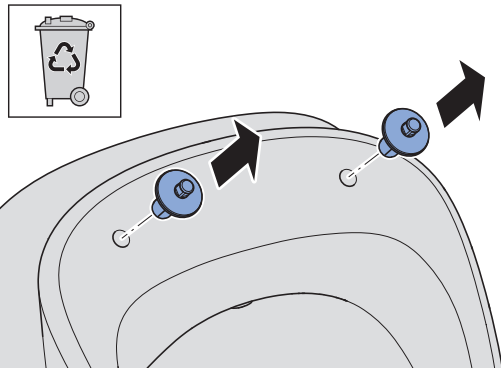

2

1

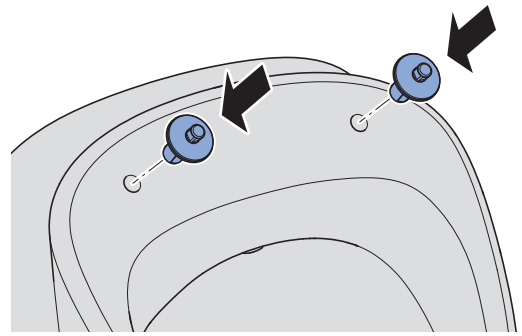
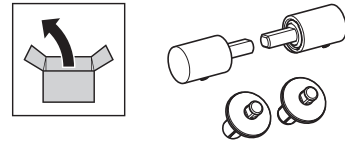

2

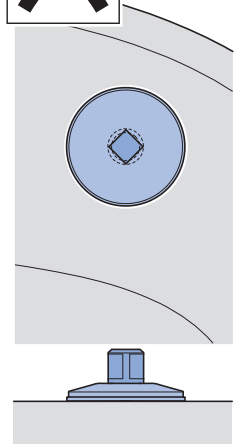
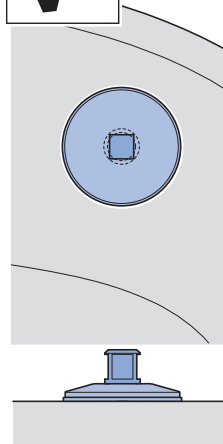
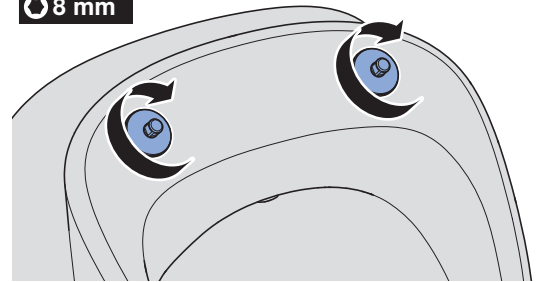
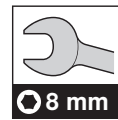

3

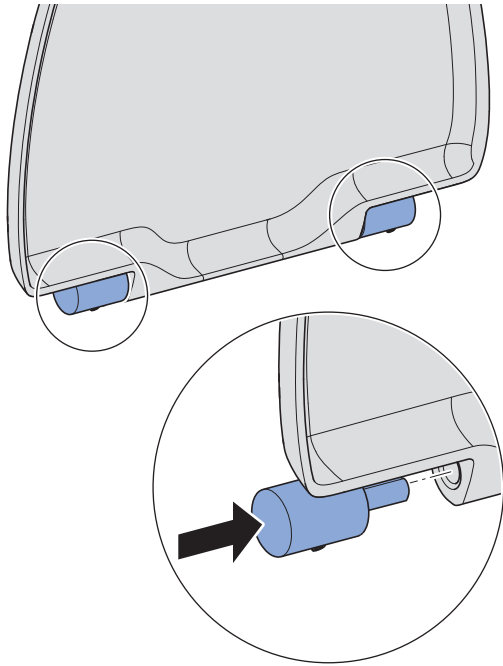

4

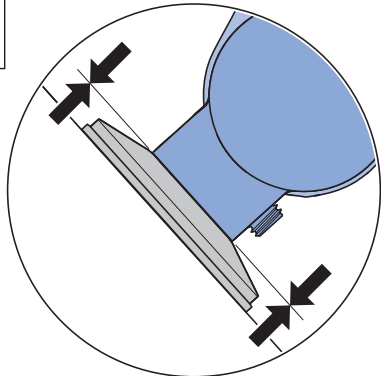
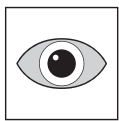
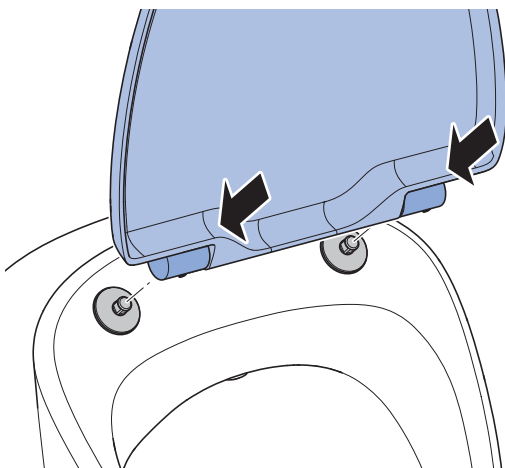

5

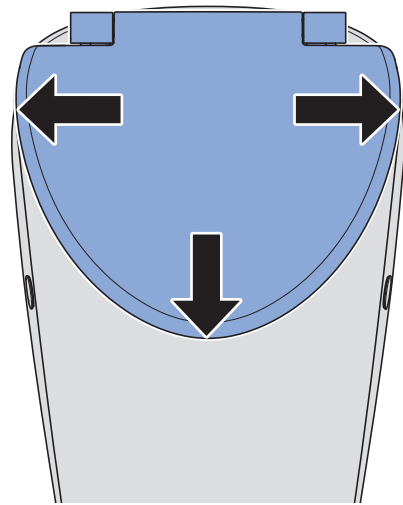

6

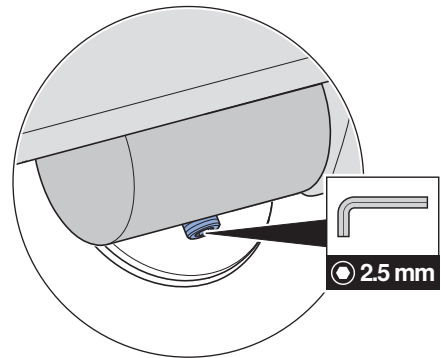
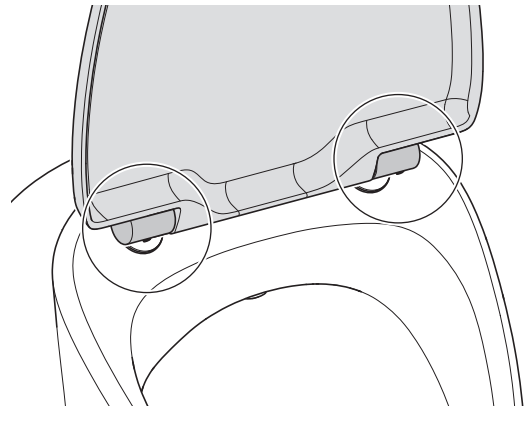

Geberit International AG
Schachenstrasse 77, CH-8645 Jona
documentation@geberit.com
www.geberit.com

