

Installation

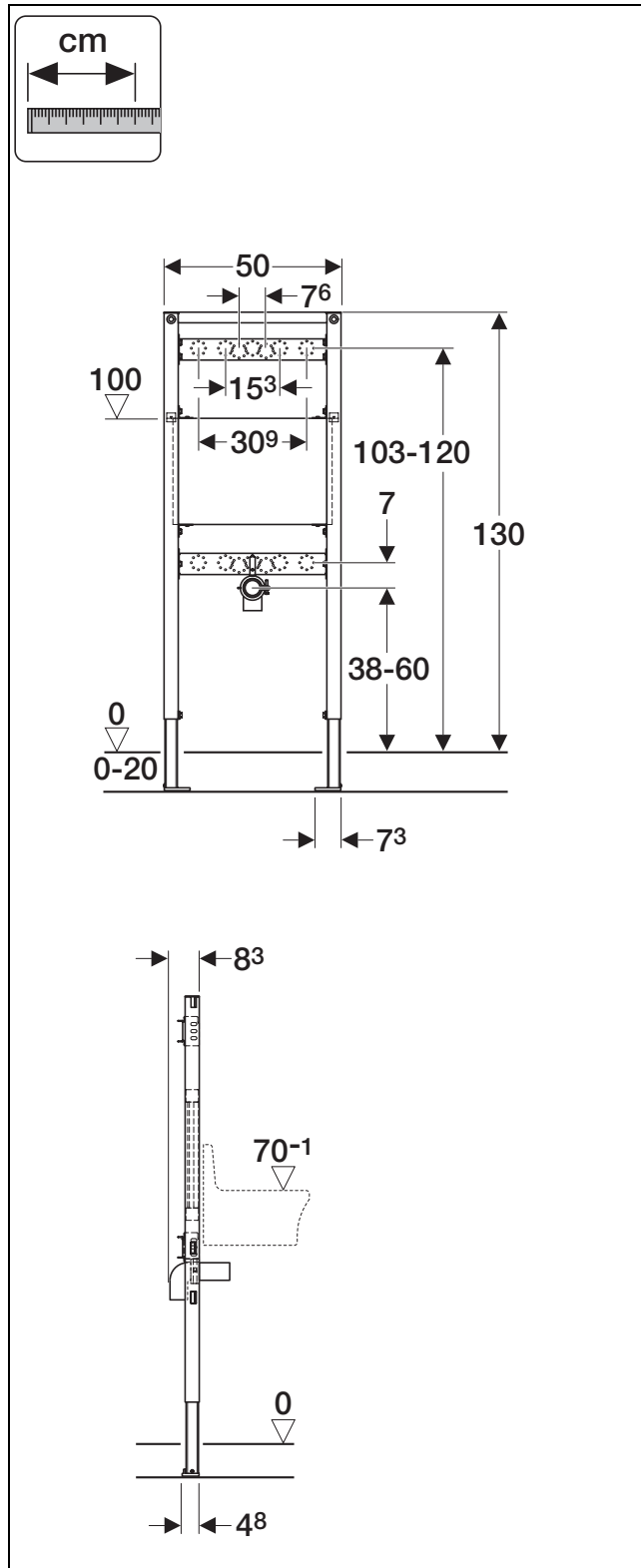

D25798-002&BDC © 02-2008

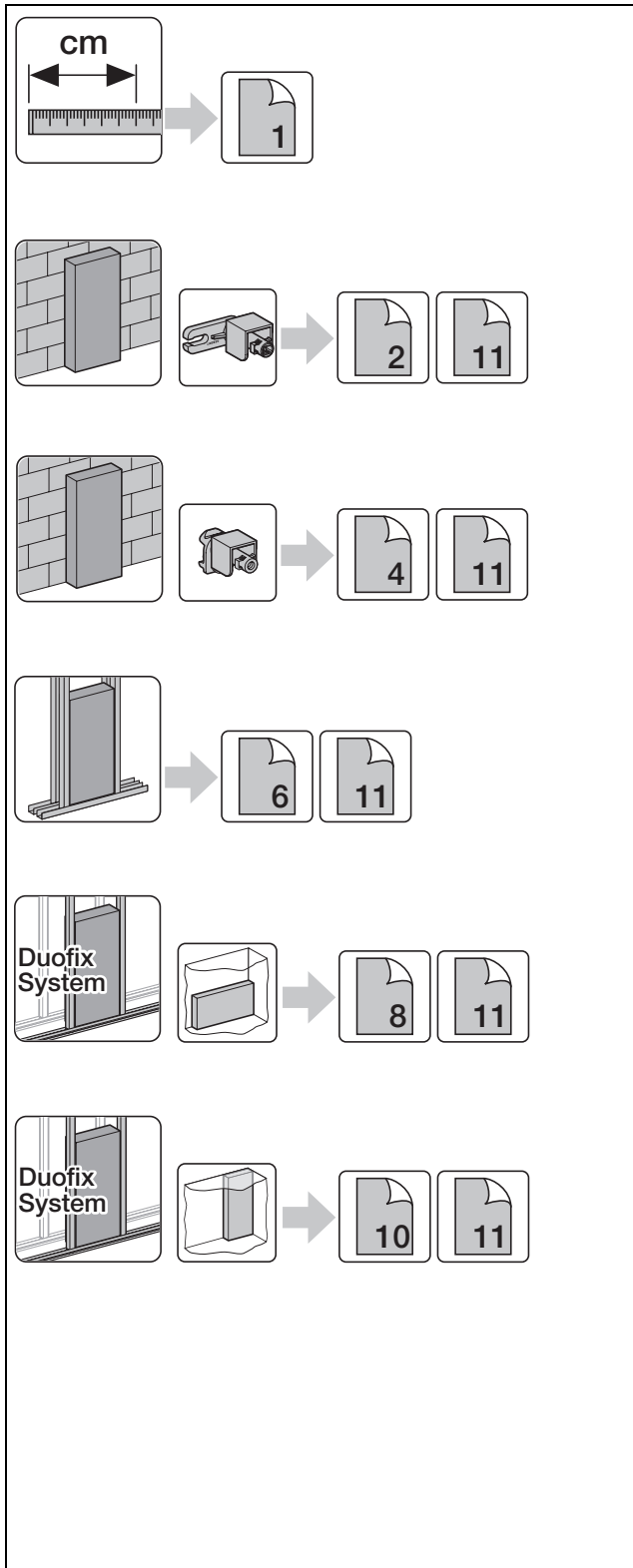

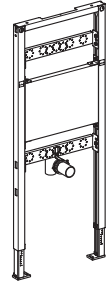
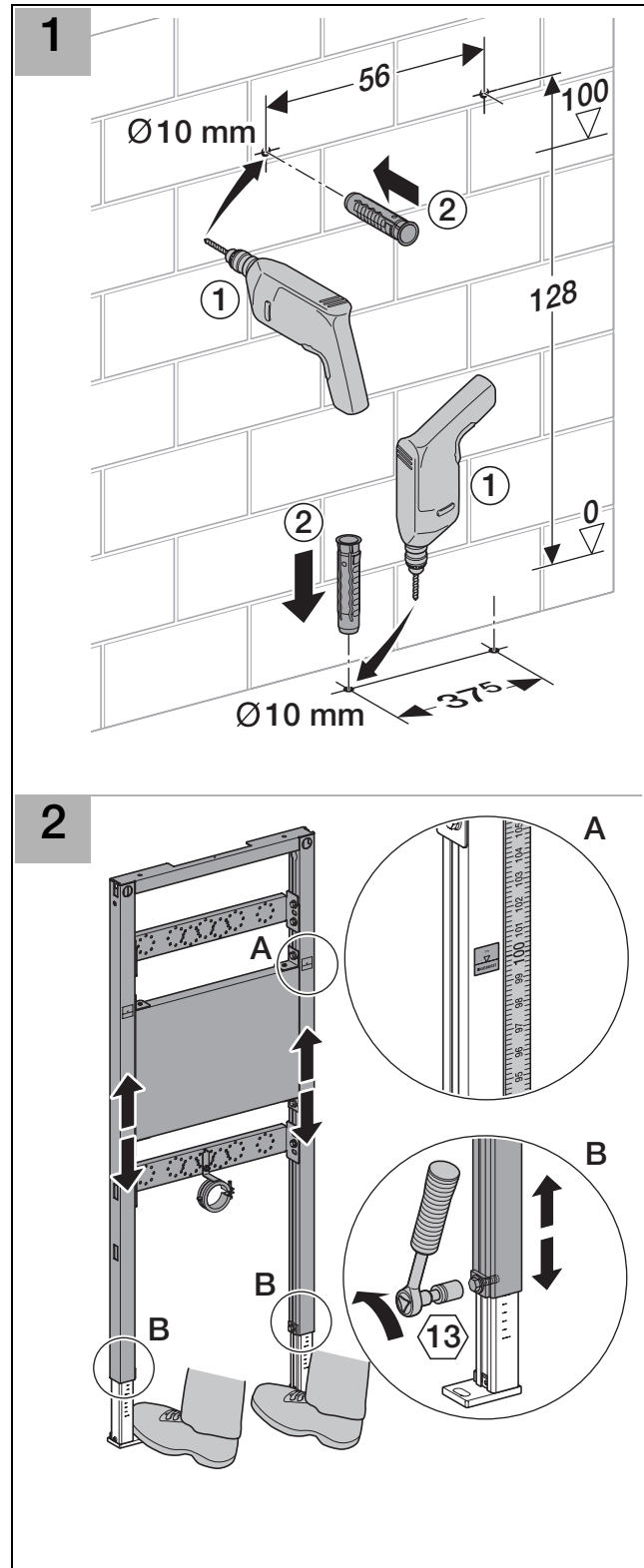
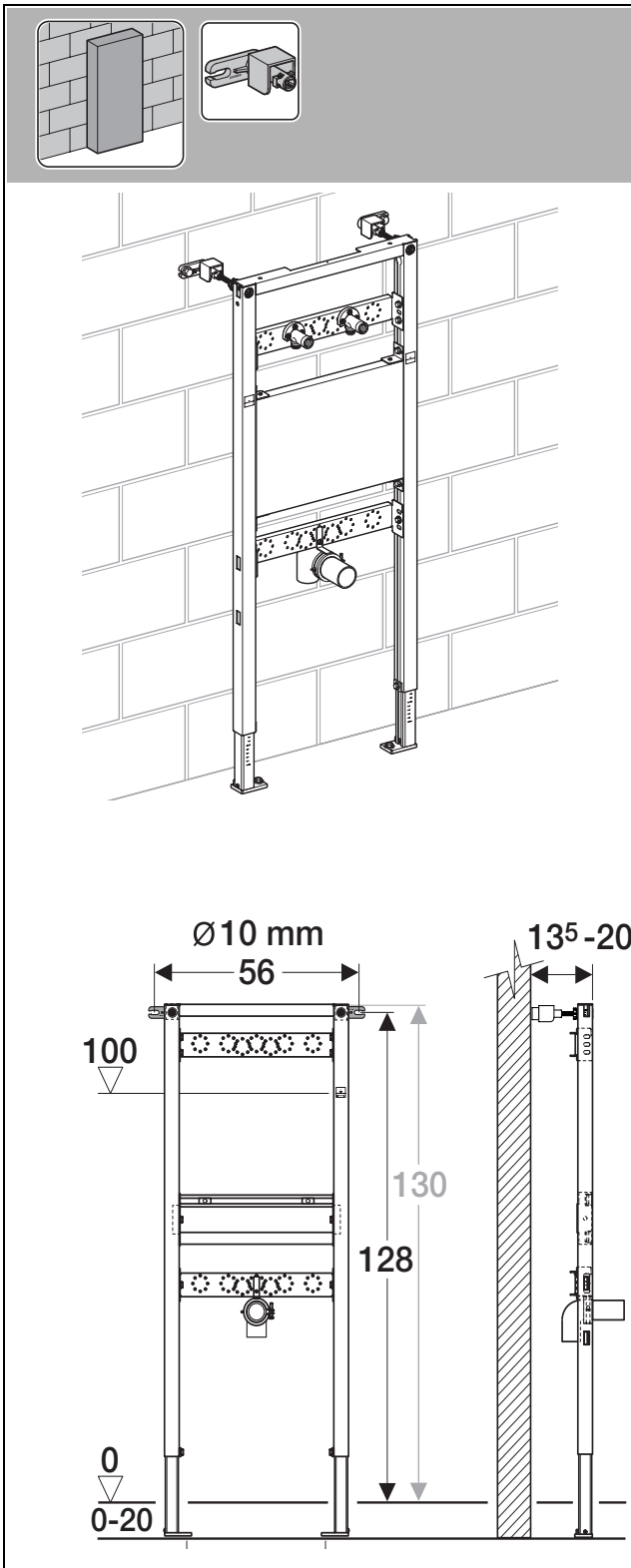
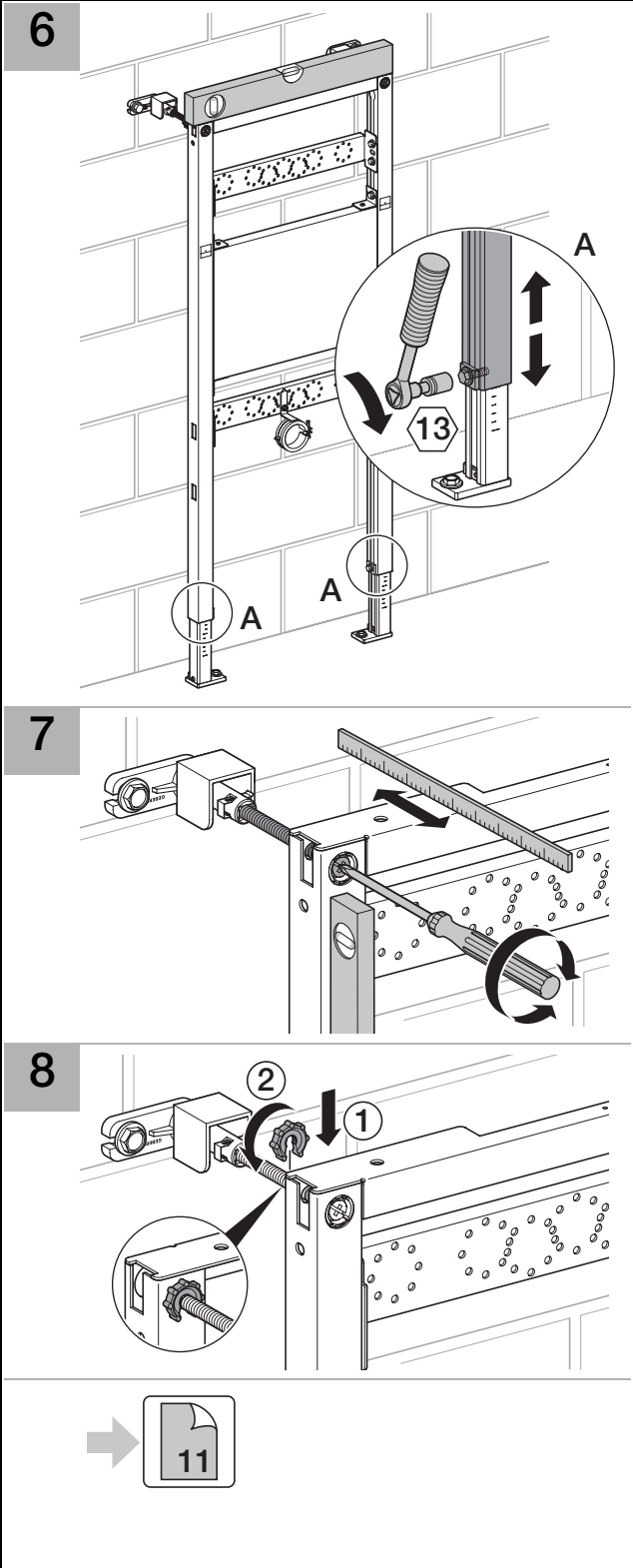
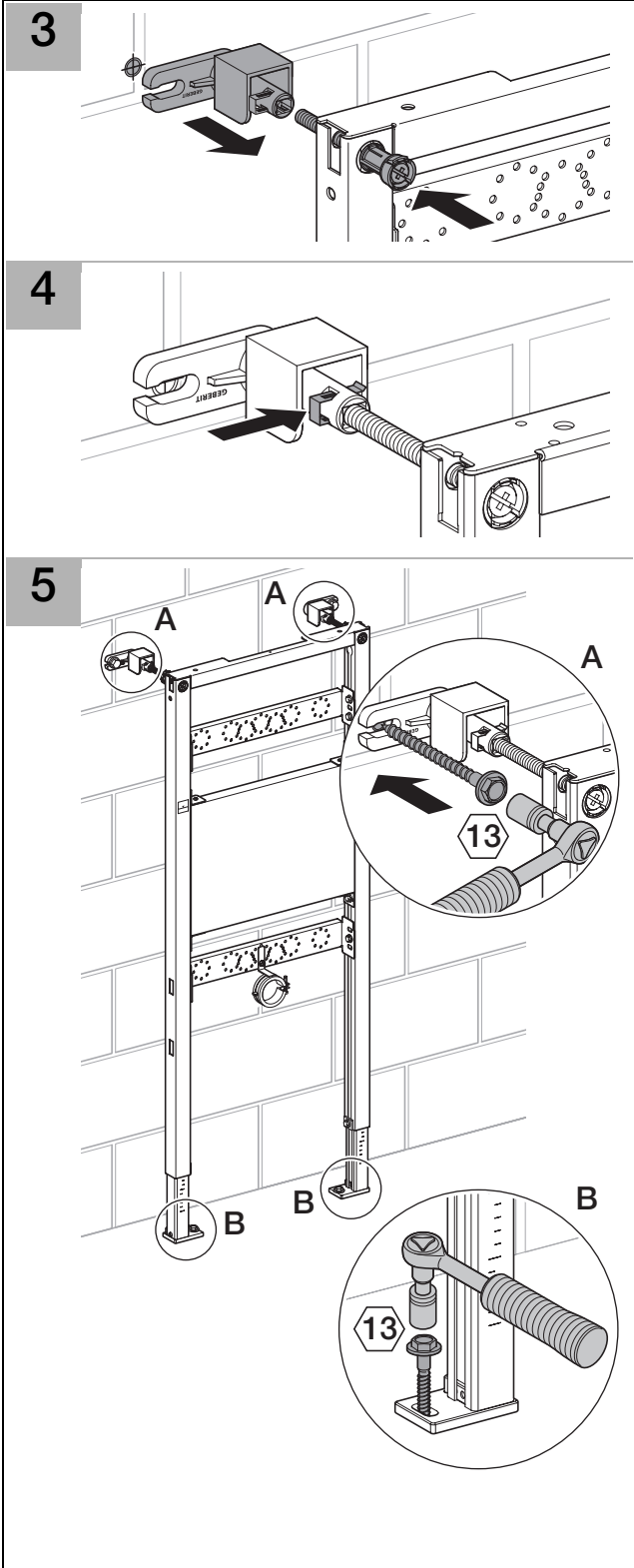

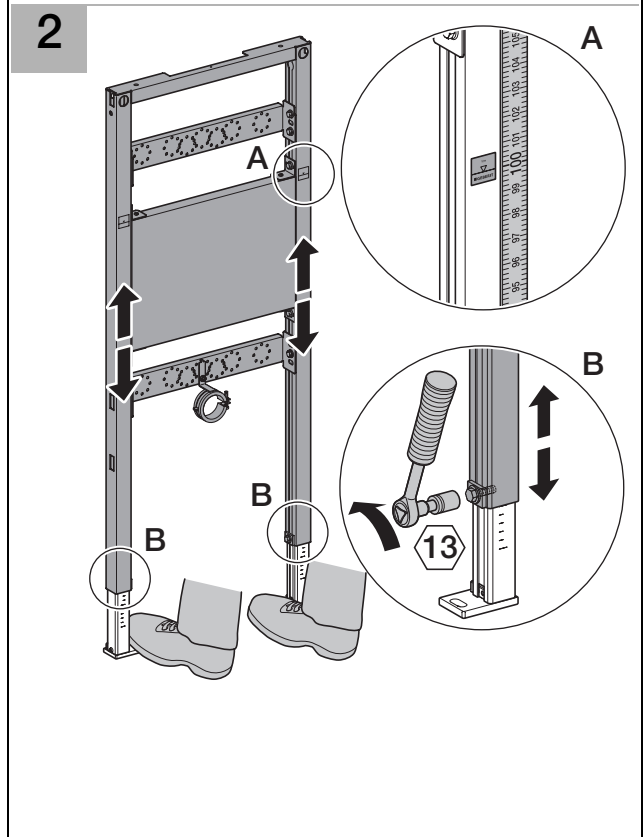
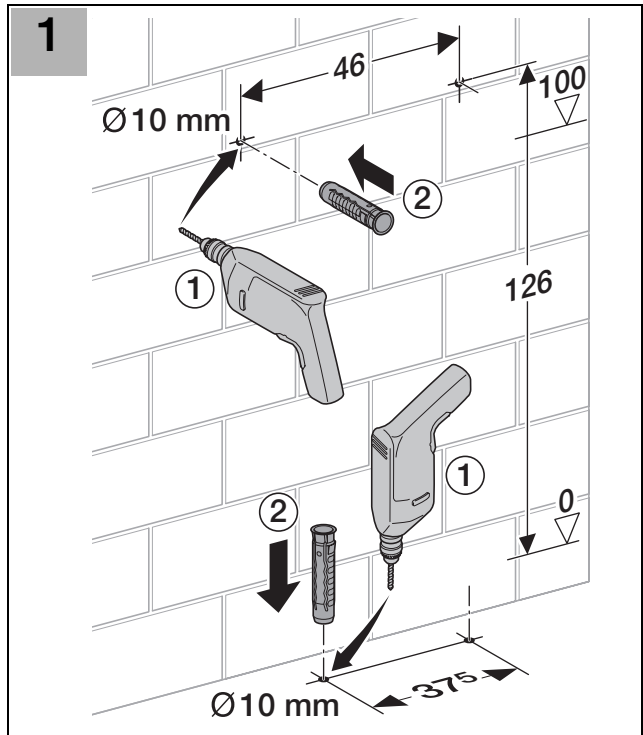
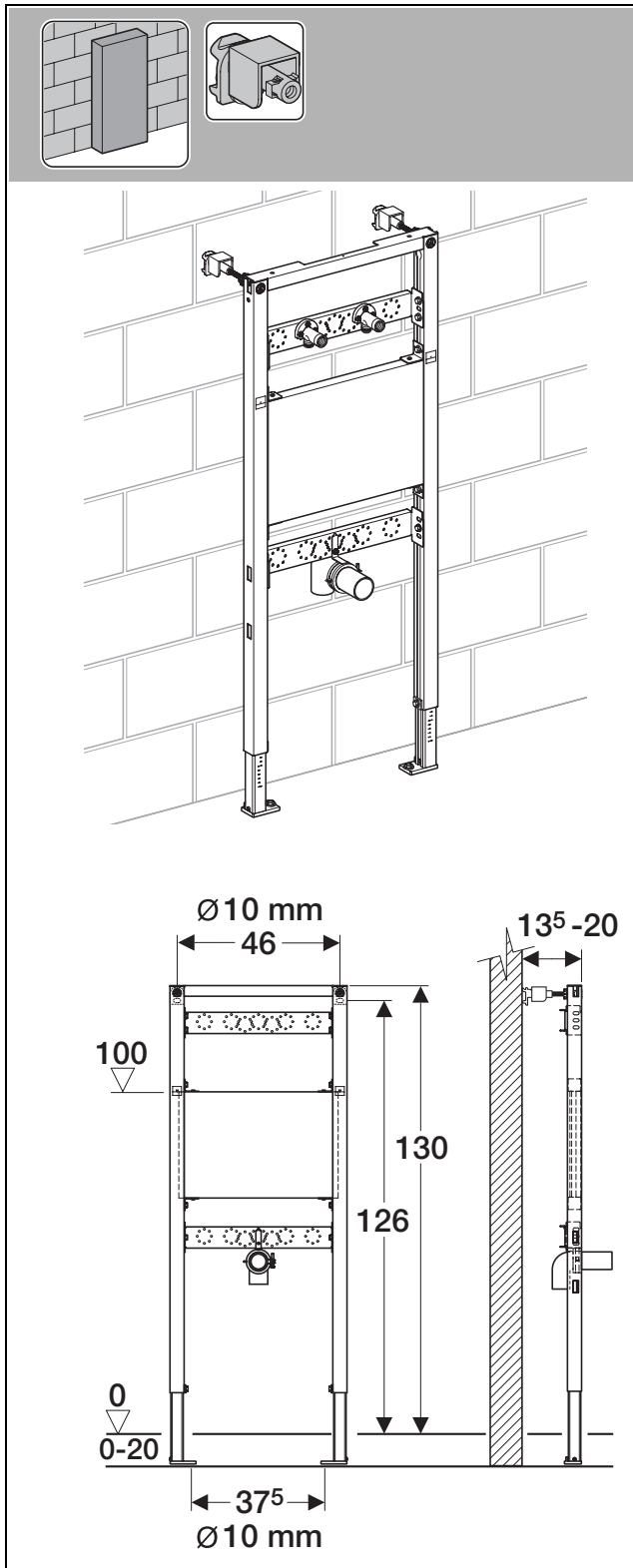

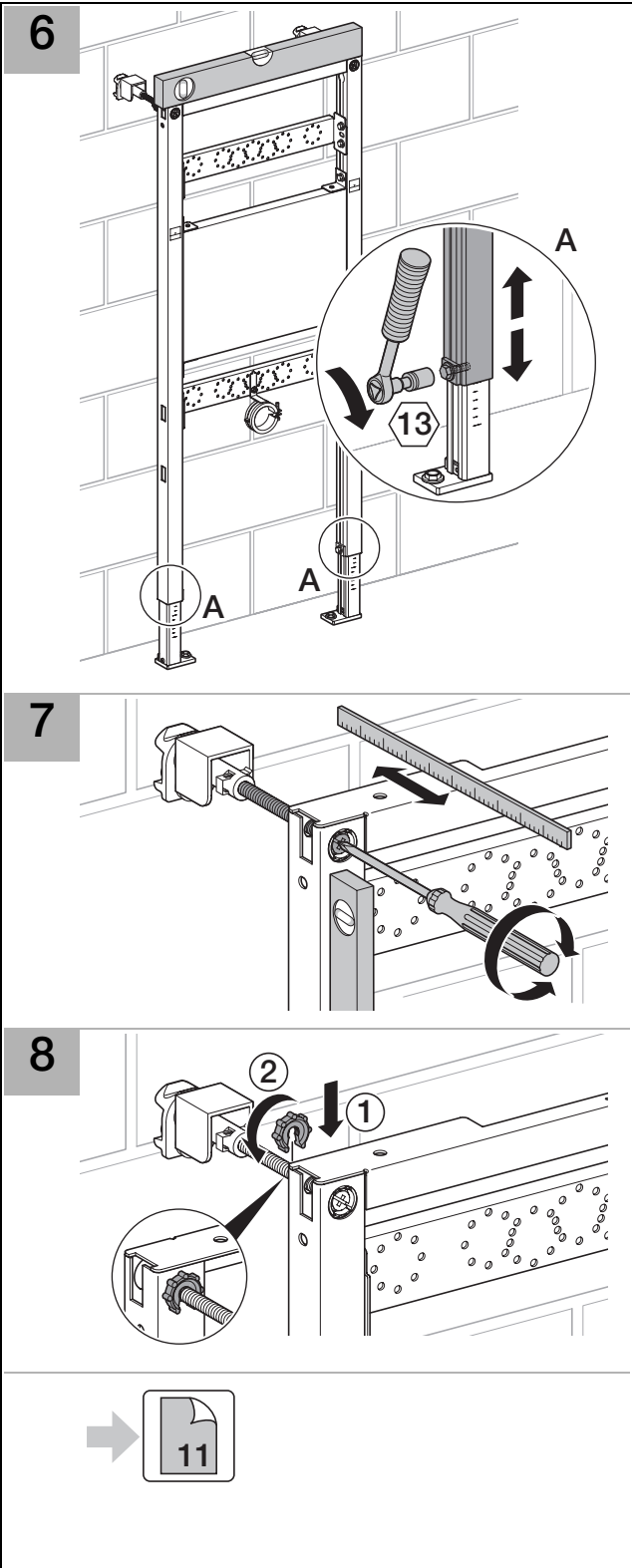
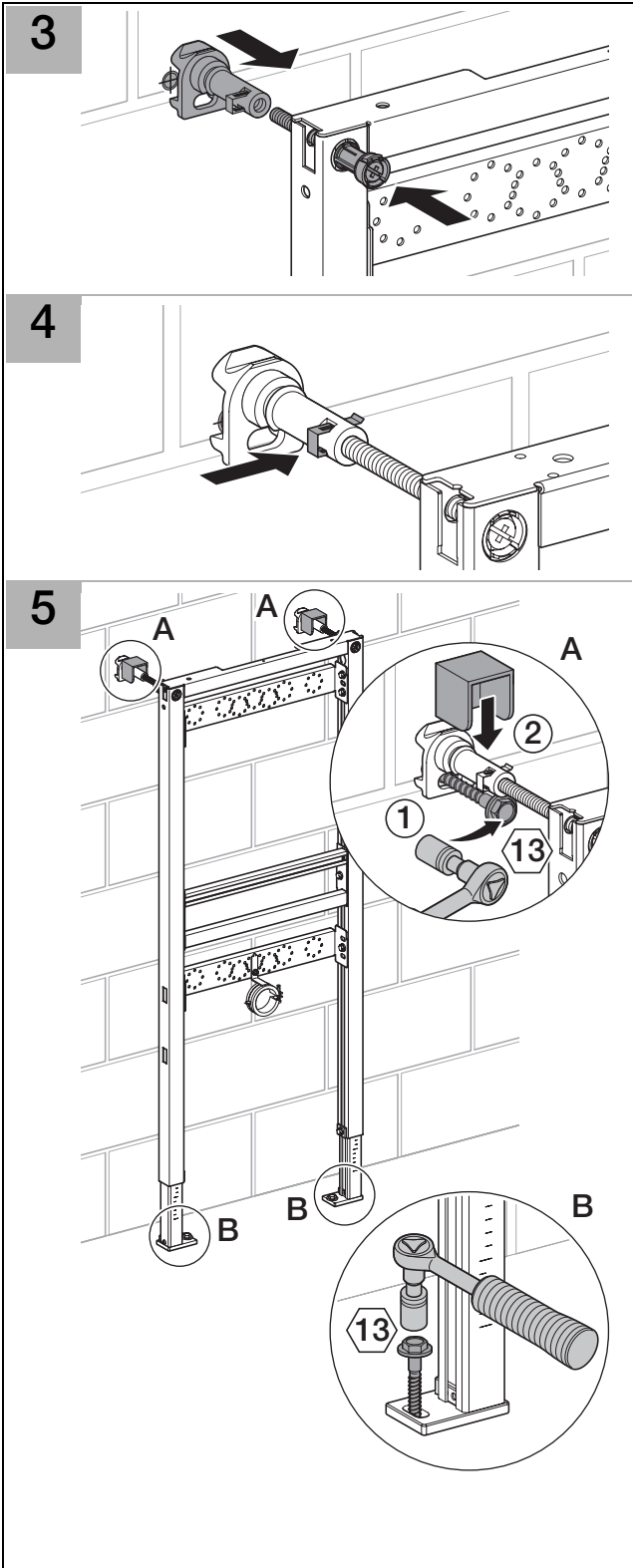

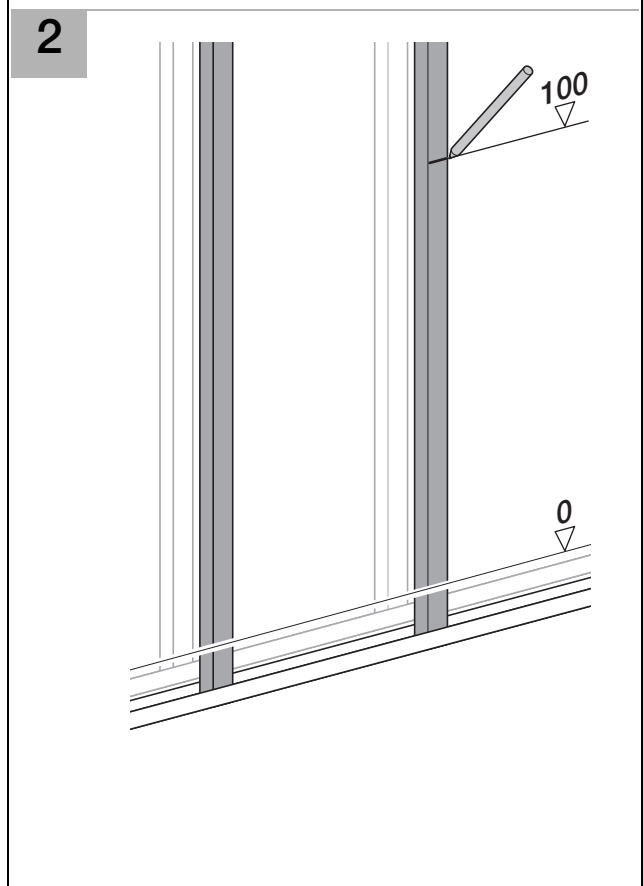
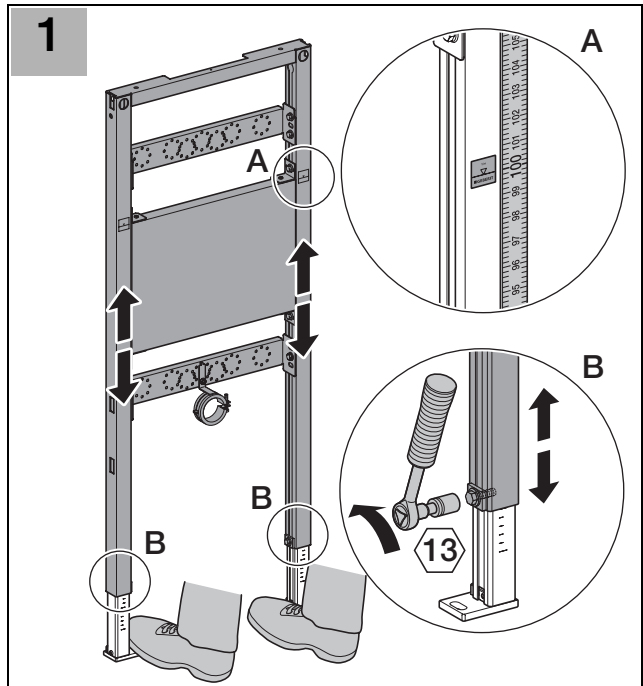
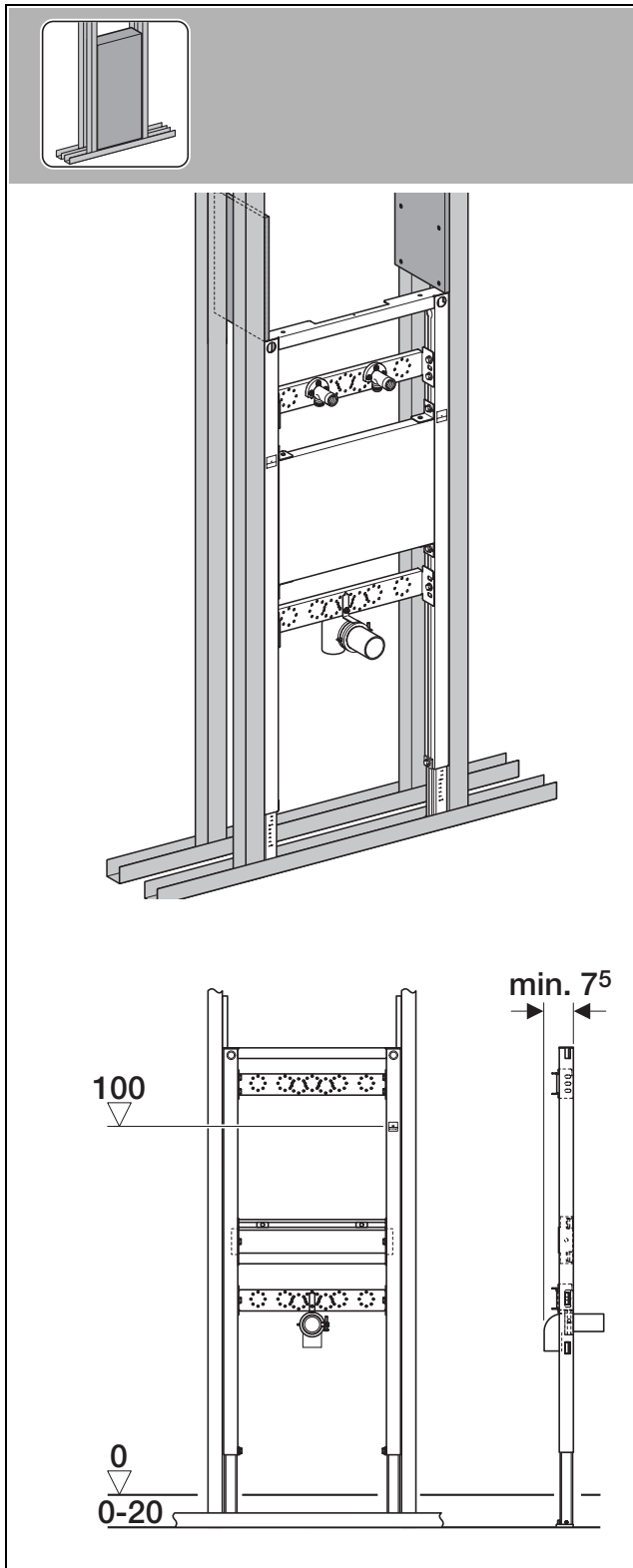

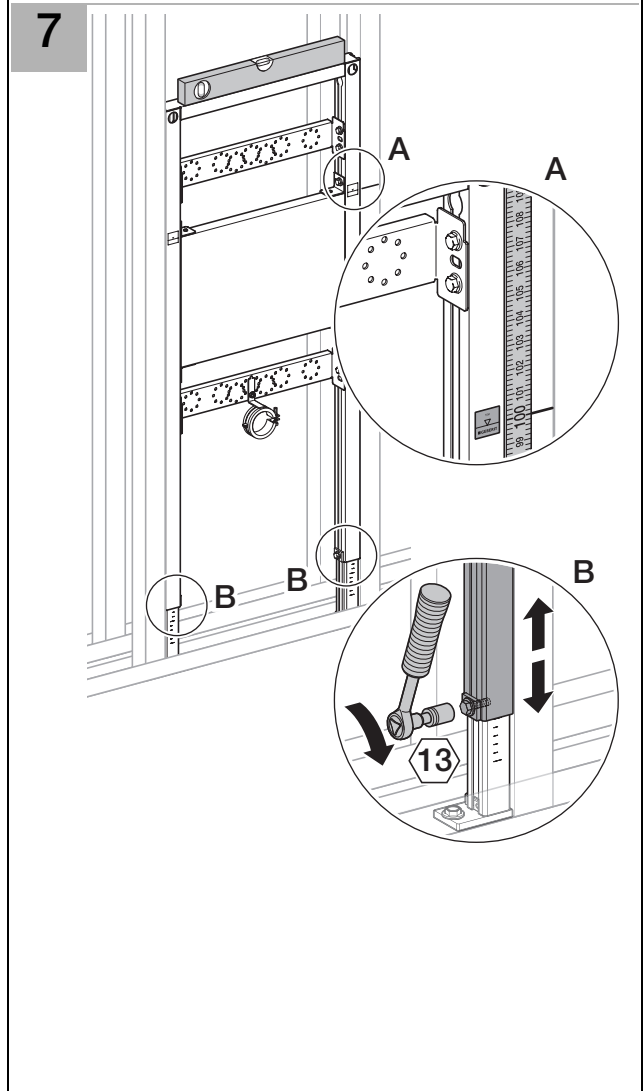
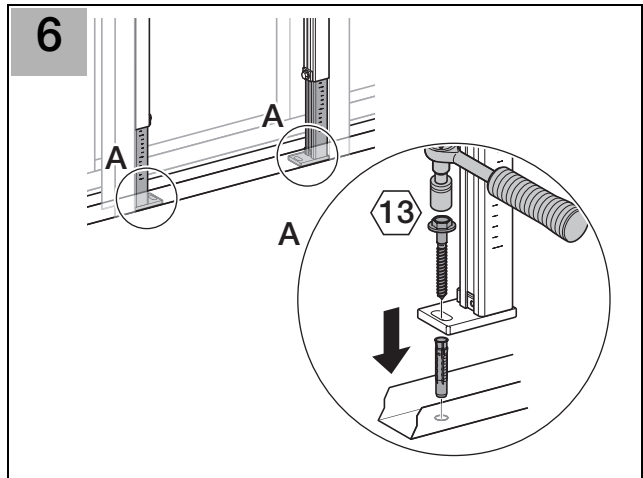
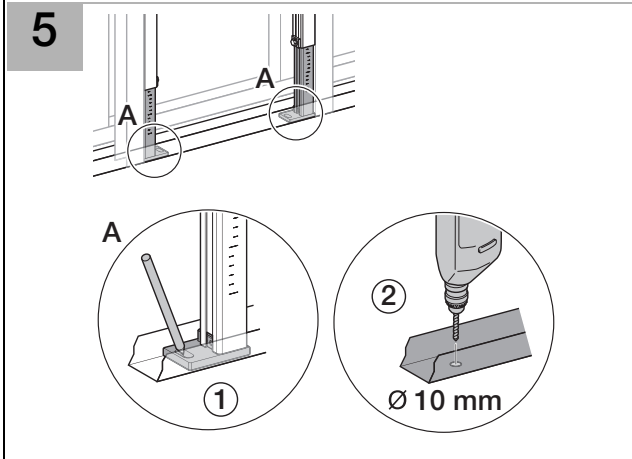
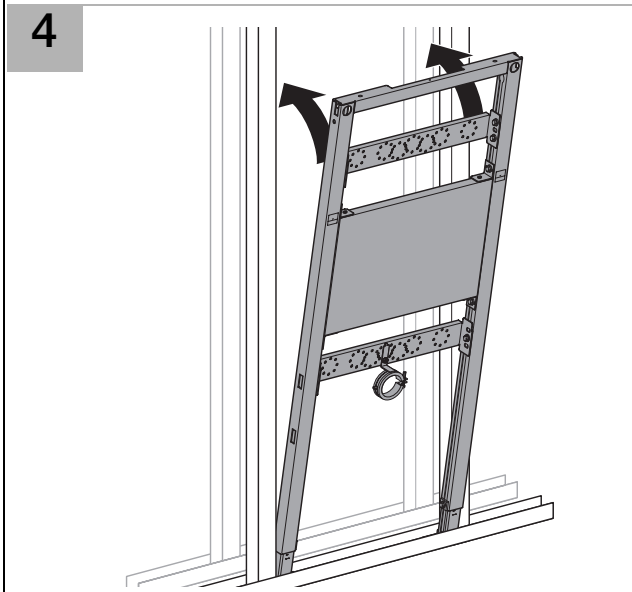
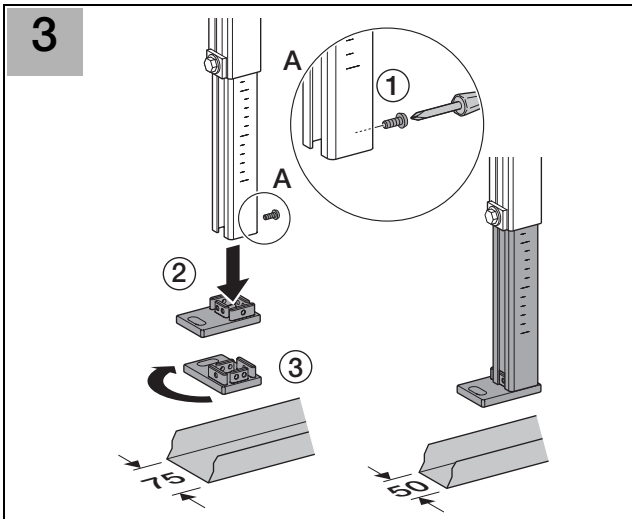

8

9

10

→ **11**

Duofix System

1

2

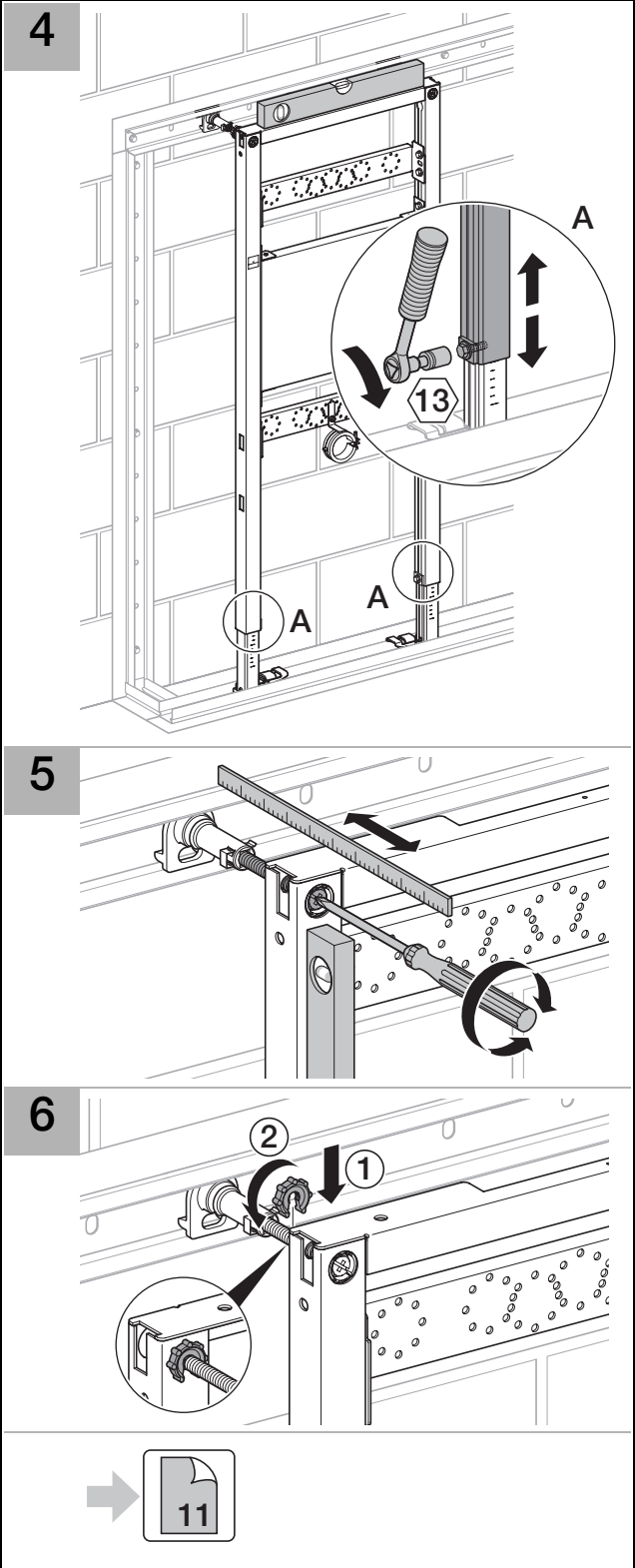
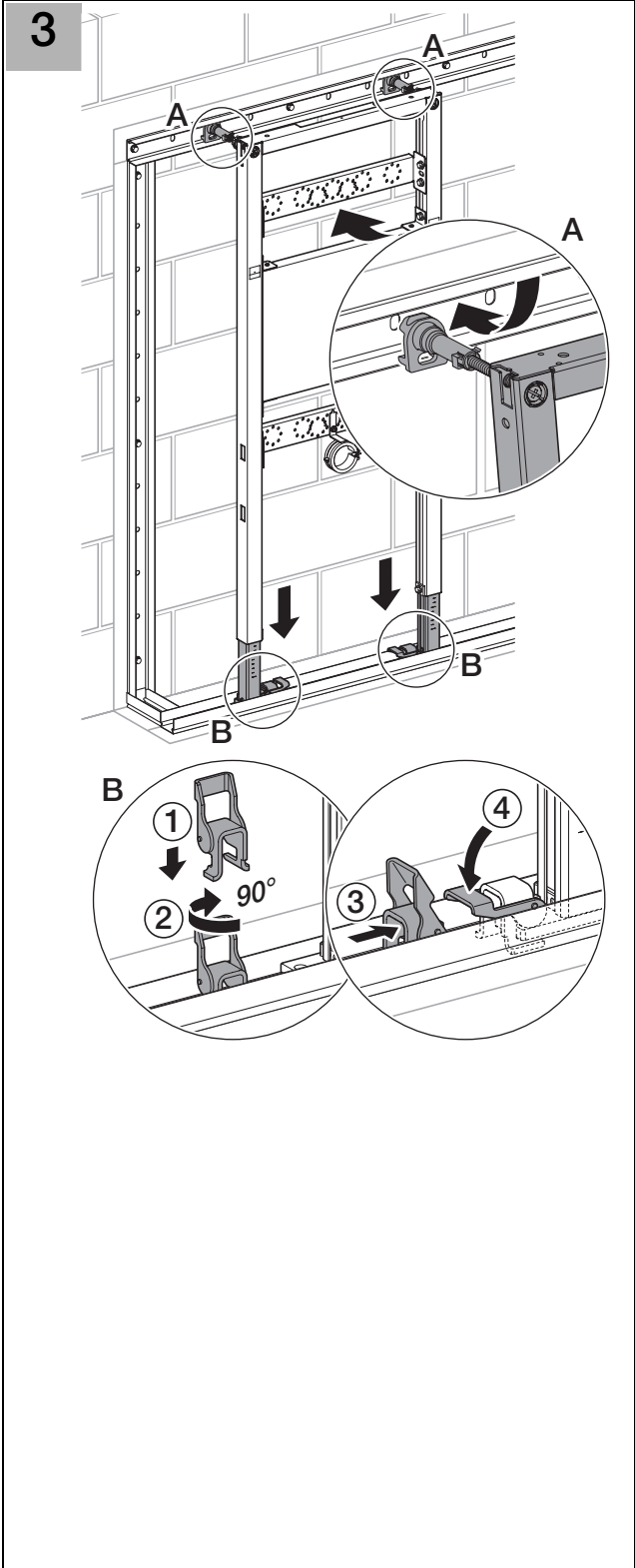

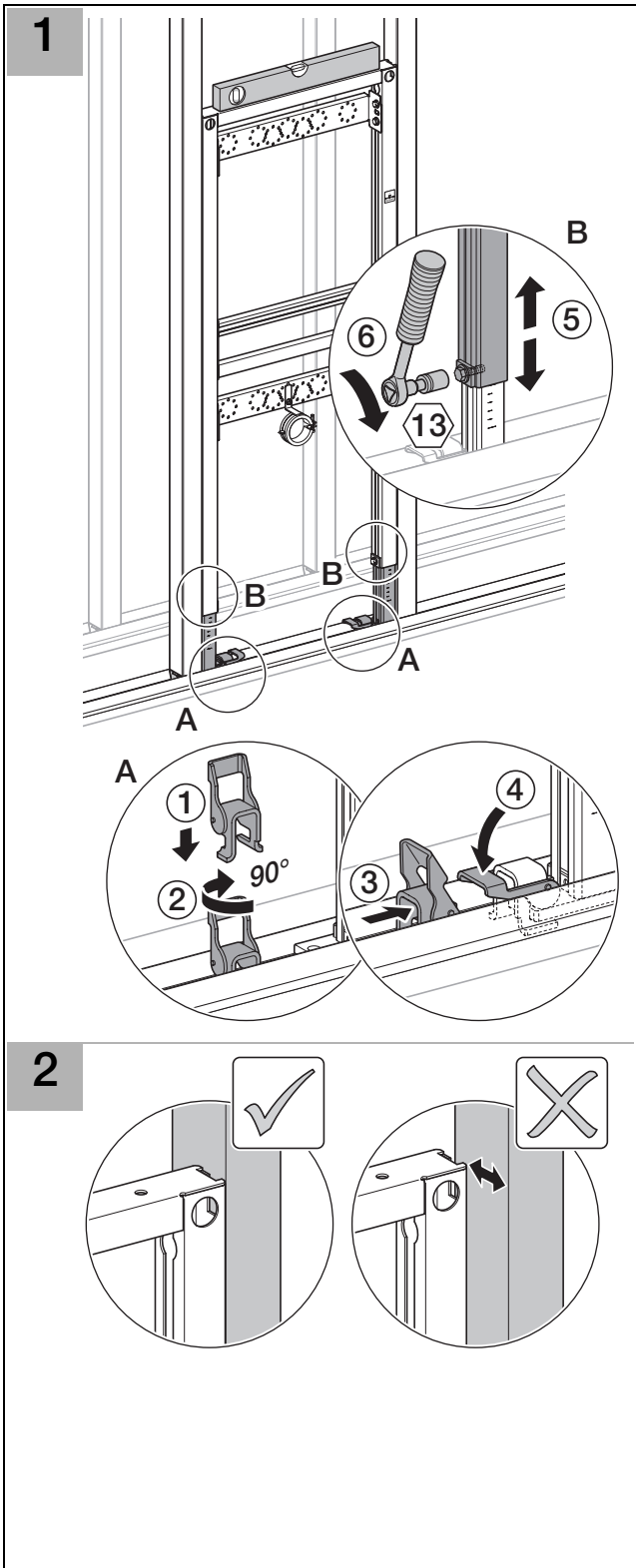
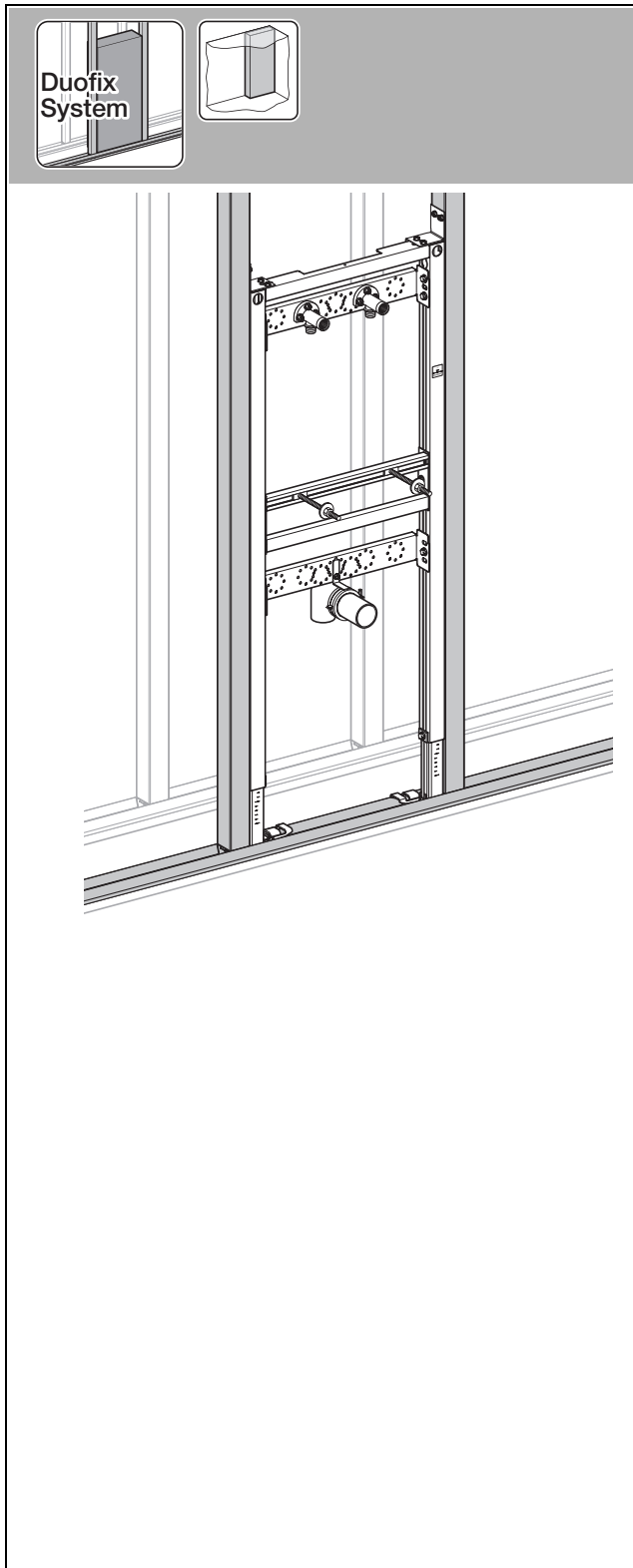

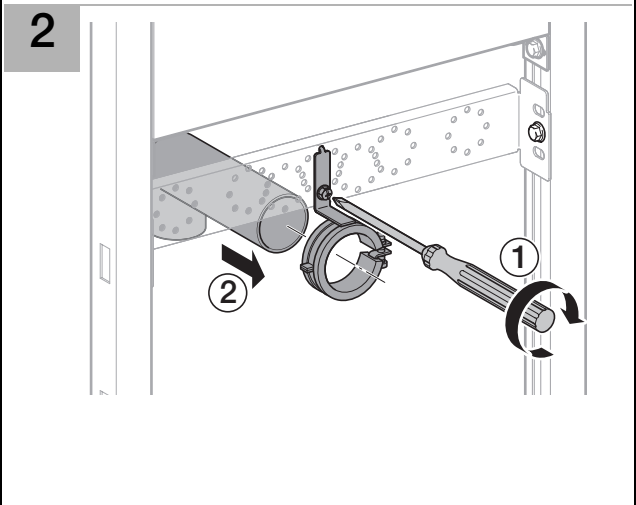
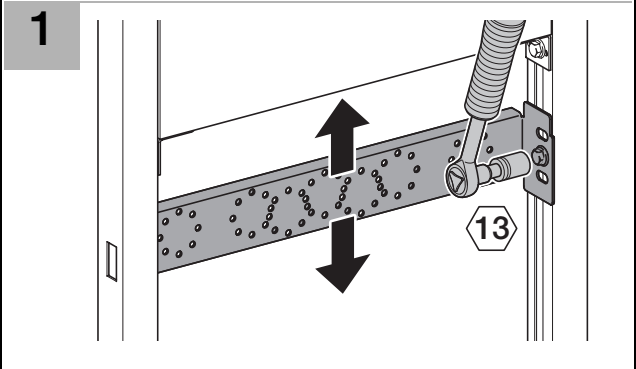
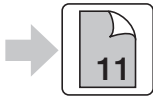
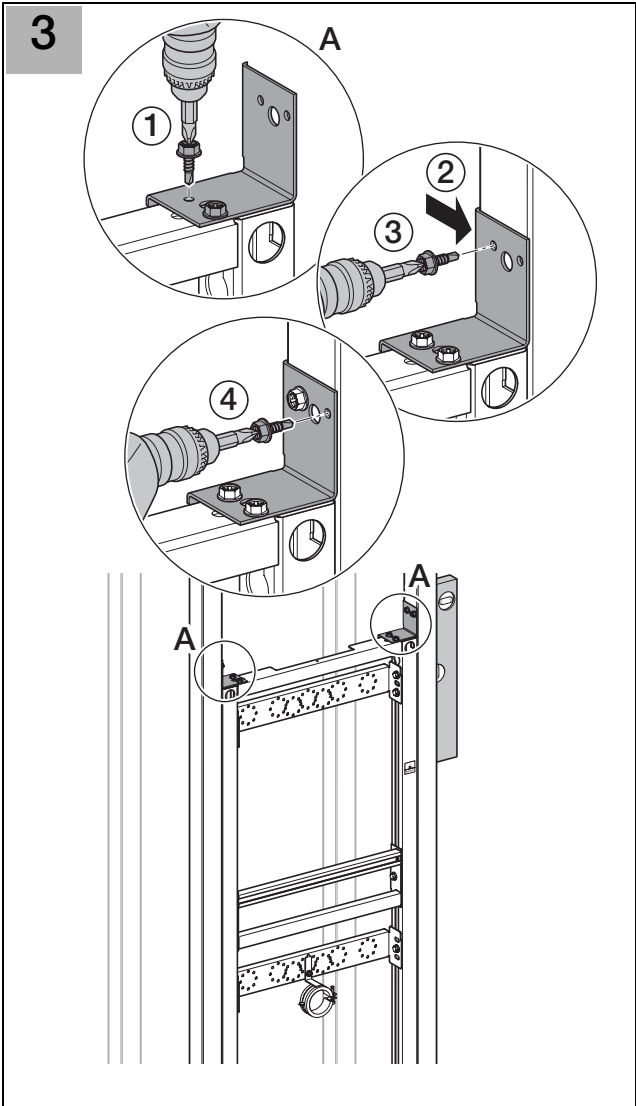

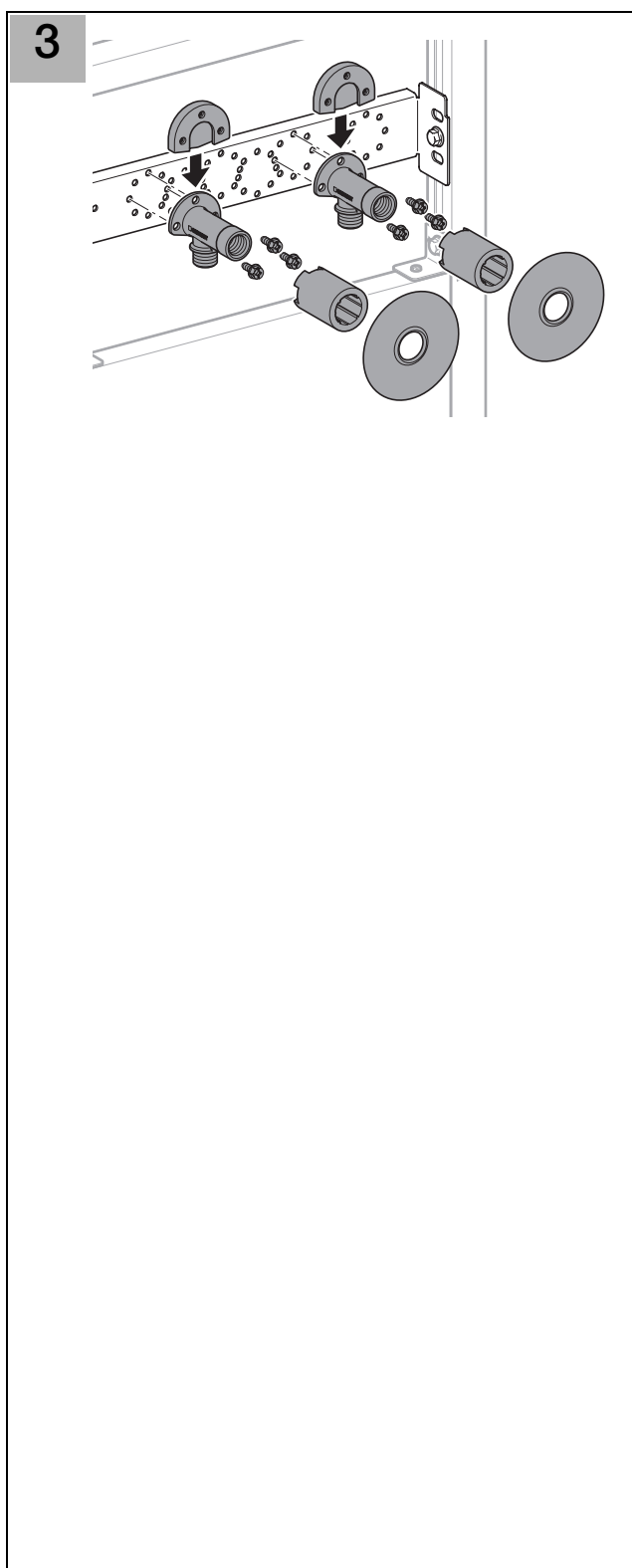

Geberit International AG
Schachenstrasse 77
CH-8645 Jona
www.geberit.com
dokumentation@geberit.com

D25798-002&BDC © 02-2008