

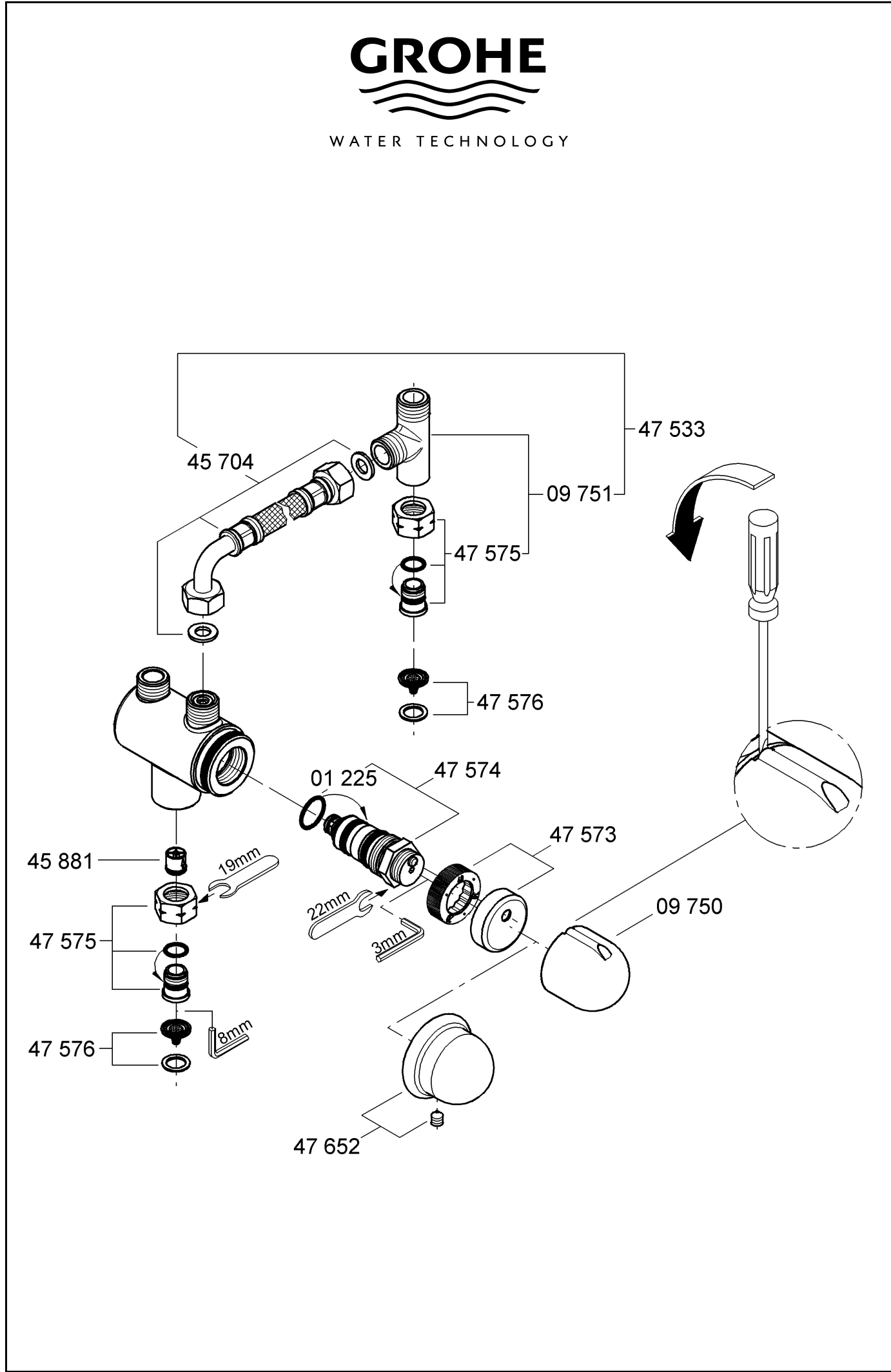

GROHE

WATER TECHNOLOGY



95.091.231/ÄM 22 207/01.02

