

DE	Gebrauchsanleitung / Montageanleitung	2
FR	Mode d'emploi / Instructions de montage	3
EN	Instructions for use / assembly instructions	4
IT	Istruzioni per l'uso / Istruzioni per Installazione	5
ES	Modo de empleo / Instrucciones de montaje	6
NL	Gebruiksaanwijzing / Handleiding	7
DK	Brugsanvisning / Monteringsvejledning	8
PT	Instruções para uso / Manual de Instalação	9
PL	Instrukcja obsługi / Instrukcja montażu	10
CS	Návod k použití / Montážní návod	11
SK	Návod na použitie / Montážny návod	12
ZH	用户手册 / 组装说明	13
RU	Руководство пользователя / Инструкция по монтажу	14
HU	Használati útmutató / Szerelési útmutató	15
FI	Käyttöohje / Asennusohje	16
SV	Bruksanvisning / Monteringsanvisning	17
LT	Vartotojo instrukcija / Montavimo instrukcijos	18
HR	Upute za uporabu / Uputstva za instalaciju	19
TR	Kullanım kılavuzu / Montaj kılavuzu	20
RO	Manual de utilizare / Instrucțiuni de montare	21
EL	Οδηγίες χρήσης / Οδηγία συναρμολόγησης	22
SL	Navodilo za uporabo / Navodila za montažo	23
ET	Kasutusjuhend / Paigaldusjuhend	24
LV	Lietošanas pamācība / Montāžas instrukcija	25
SR	Uputstvo za upotrebu / Uputstvo za montažu	26
NO	Bruksanvisning / Montasjeveiledning	27
BG	Инструкция за употреба / Ръководство за монтаж	28
SQ	Udhëzuesi i përdorimit / Udhëzime rreth montimit	29
AR	دليل الاستخدام / تعليمات التجميع	30

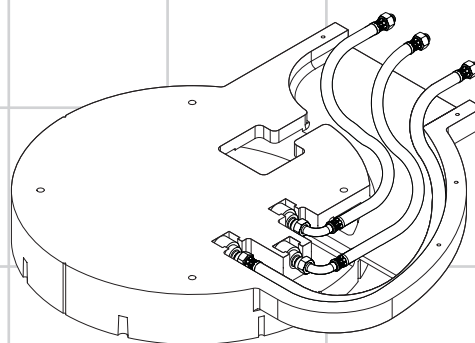

Rainmaker
2841218X

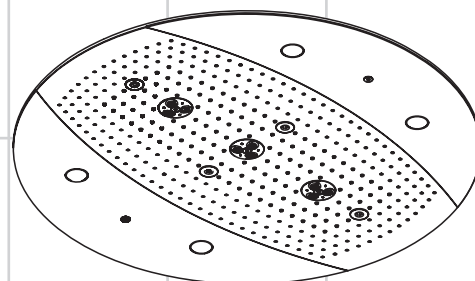

Rainmaker
28403000 / 28404000

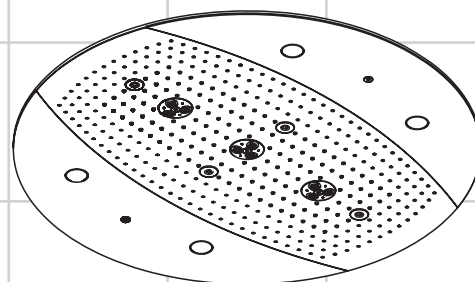
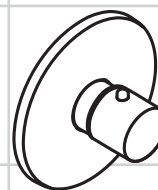

Rainmaker
26115000 / 26117000



Sicherheitshinweise

- ⚠ Bei der Montage müssen zur Vermeidung von Quetsch- und Schnittverletzungen Handschuhe getragen werden.
- ⚠ Das Produkt darf nur zu Bade-, Hygiene- und Körperreinigungszwecken eingesetzt werden.
- ⚠ Kinder, sowie Erwachsene mit körperlichen, geistigen und / oder sensorischen Einschränkungen dürfen das Produkt nicht unbeaufsichtigt benutzen. Personen, die unter Alkohol- oder Drogeneinfluss stehen, dürfen das Produkt nicht benutzen.
- ⚠ Der Kontakt der Brausestrahlen mit empfindlichen Körperstellen (z. B. Augen) muss vermieden werden. Es muss ein ausreichender Abstand zwischen Brause und Körper eingehalten werden.
- ⚠ Große Druckunterschiede zwischen den Kalt- und Warmwasseranschlüssen müssen ausgeglichen werden.

Elektroanschluss

- ⚠ Der Elektroanschluss darf nur vom Elektrofachmann durchgeführt werden!
- ⚠ Spannungsversorgung 100-240V/N/PE/50-60Hz (Länge: 0,3 m) vorinstallieren.
- ⚠ Die Absicherung muss über eine Fehlerstrom-Schutzeinrichtung (RCD/ FI) mit einem Bemessungsdifferenzstrom ≤ 30 mA erfolgen.
- ⚠ Das Produkt muss an einen bauseits vorhandenen Potentialausgleich (PA) 4 mm² angeschlossen werden.

Elektroinstallateur

- ⚠ Die Installations- und Prüfungsarbeiten sind von einer zugelassenen Elektrofachkraft, unter Berücksichtigung von VDE 0100 Teil 701, IEC 60364-6 u. IEC 60364-7-701 sowie EN 60335-2-105, auszuführen.
- ⚠ Die Netzanschlussleitung muss doppelt isoliert in die Anschlussdose eingeführt werden.

Montagehinweise

- Vor der Montage muss das Produkt auf Transportschäden untersucht werden. Nach dem Einbau werden keine Transport- oder Oberflächenschäden anerkannt.
- Die Leitungen und die Armatur müssen nach den gültigen Normen montiert,

gespült und geprüft werden.

- Die in den Ländern jeweils gültigen Installationsrichtlinien sind einzuhalten.
- Bei der Montage des Produktes durch qualifiziertes Fachpersonal ist darauf zu achten, dass die Befestigungsfläche im gesamten Bereich der Befestigung plan ist (keine vorstehenden Fugen oder Fliesenversatz), der Wandaufbau für eine Montage des Produktes geeignet ist und keine Schwachstellen aufweist.
- Beim Bohren auf Strom- und Wasserleitungen achten!
- Die Ablaufleistung muss ausreichend dimensioniert werden.
- Die Brause darf nur nach einem Absperrventil oder einer Sanitärarmatur angeschlossen werden.
- Das Produkt ist nicht für die Verwendung in Verbindung mit einem Dampfbad vorgesehen!

Technische Daten

Betriebsdruck vor der Armatur:	max. 1 MPa
Empfohlener Betriebsdruck:	0,3 - 0,5 MPa (1 MPa = 10 bar = 147 PSI)
Heißwassertemperatur:	max. 60 °C
Empfohlene Heißwassertemperatur:	42 °C
Sicherheitsperre:	40 °C
Warnhinweis: Eine Überschreitung dieser Temperatur kann zu Verbrennungen führen!	
Thermische Desinfektion:	max. 70 °C / 4 min
Nennspannung	100-240V AC 50-60Hz
Nennaufnahme	18 W
Leuchten 4 x LED:	12V DC SELV 4 W
Das Leuchtmittel ist nicht dimmbar.	
Schutzklasse	II
Schutzart	IPX5

Symbolerklärung

	Kein essigsäurehaltiges Silikon verwenden!		Wasseranschluss DN20		Leerrohr für Stromversorgung
	Maße (siehe Seite 32)		Warmwasser		Warnung vor heißer Oberfläche!
	Montagebeispiele (siehe Seite 34)		Wasseranschluss DN20		Schutzhandschuhe tragen
	Bedienung (siehe Seite 31)		Kaltwasser		Augenschutz tragen
	Serviceteile (siehe Seite 31)		Unterputz-Ventil		Naturschwamm
	Service Leuchtmittel austauschen (siehe Seite 53)		Quattro Vierwegeumstellung		Entkalker (zitronensäurebasis) Augen- und Hautkontakt vermeiden. Falls das Produkt in die Augen gelangt, diese gründlich mit Wasser ausspülen.
	Reinigung (siehe Seite 50)		Trio Universal Absperr- und Umstellventil		
	Elektroinstallateur		Trio HighFlow		Strom an / aus
	Wartung (siehe Seite 54) Die Schutzeinrichtung muss in regelmäßigen Abständen auf ihre Funktion überprüft werden.		Thermostat HighFlow		Prüfzeichen (siehe Seite 55)
			Die Ablaufleistung muss mehr als 50 l/min betragen.		
			Ablauf		
			Mitte Duschwanne		
			Wasser öffnen / Wasser abstellen		



Montage Grundset (siehe Seite 42)



Montage Fertigset (siehe Seite 47)



Consignes de sécurité

- ⚠ Lors du montage, porter des gants de protection pour éviter toute blessure par écrasement ou coupure.
- ⚠ Le produit ne doit servir qu'à se laver et à assurer l'hygiène corporelle.
- ⚠ Il est interdit aux enfants ainsi qu'aux adultes ayant des insuffisances physiques, psychiques et/ou motoriques d'utiliser la douche sans surveillance. De même, il est interdit à des personnes sous influence d'alcool ou de drogues d'utiliser la douche.
- ⚠ Éviter le contact du jet de la douchette avec les parties sensibles du corps (telles par ex. que les yeux). Veiller à respecter un écart suffisant entre la douchette et le corps
- ⚠ Il est conseillé d'équilibrer les pressions de l'eau chaude et froide.

⚡ Raccord électrique

- ⚠ Seul un spécialiste est autorisé à réaliser le câblage!
- ⚠ Pré-installer l'alimentation en tension de 100-240V/N/PE/50-60Hz (longueur : 0,3 m).
- ⚠ La protection par fusibles doit se faire avec un dispositif de protection par courant de défaut (RCD/ FI) avec un courant différentiel résiduel de maximum 30 mA.
- ⚠ Le produit doit être raccordé à une liaison équipotentielle du propriétaire (PA) 4 mm².

⚡ Électricien installateur

- ⚠ Les travaux d'installation et de contrôle doivent être confiés à un électricien agréé, en respectant VDE 0100 partie 701, IEC 60364-6 et IEC 60364-7-701 ainsi que EN 60335-2-105.
- ⚠ Le câble secteur doit être introduit dans la prise de raccord, avec une double isolation .

Instructions pour le montage

- Avant son montage, s'assurer que le produit n'a subi aucun dommage pendant le transport. Après le montage, tout dommage de transport ou de surface ne pourra pas être reconnu.
- Les conduites et la robinetterie doivent être montés, rincés et contrôlés selon les





























normes en vigueur.

- Les directives d'installation en vigueur dans le pays concerné doivent être respectées.
- Lors du montage de ce produit par du personnel qualifié, veiller à ce que la surface de fixation soit bien plane dans toute la zone de fixation (pas de dépassement de joints ou de déport de carreaux), à ce que le mur se prête au montage du produit et ne présente aucun point fragile.
- Lors de travaux de perçage sur des conduites électriques et des conduites d'eau!
- Le débit du vidage doit être suffisamment dimensionné.
- La douchette ne doit être raccordée qu'en aval d'une vanne d'arrêt ou d'une robinetterie sanitaire.
- Le produit n'est pas prévu pour une utilisation en liaison avec un bain à vapeur

Informations techniques

Pression de service devant la robinetterie:	max. 1 MPa
Pression de service conseillée:	0,3 - 0,5 MPa (1 MPa = 10 bar = 147 PSI)
Température d'eau chaude:	max. 60 °C
Température recommandée:	42 °C
Blocage de sécurité:	40 °C
⚠ Avertissement: tout dépassement de cette température peut entraîner des brûlures	
Désinfection thermique:	max. 70 °C / 4 min
Tension nominale	100-240V AC 50-60Hz
Consommation nominale	18 W
Lampes 4 x LED:	12V DC SELV 4 W
Source lumineuse dont la luminosité ne peut pas être atténuée.	
Classe de protection	II
Mode de protection	IPX5

Description du symbole

	Ne pas utiliser de silicone contenant de l'acide acétique!		Raccord d'eau DN20		Gaine pour alimentation en courant électrique
	Dimensions (voir pages 32)		Eau chaude		Attention à la température élevée à la surface !
	Exemples de montage (voir pages 34)		Raccord d'eau DN20		Protection obligatoire des mains
	Instructions de service (voir pages 31)		Eau froide		Protection obligatoire de la vue
	Pièces détachées (voir pages 31)		Robinet d'arrêt encastré		éponge naturelle
	Service Remplacer l'élément lumineux (voir pages 53)		Quattro inverseur quatre voies		Détartrant (À base d'acide citrique)
	Nettoyage (voir pages 50)		Trio Robinet d'arrêt avec inverseur		Éviter tout contact avec les yeux et la peau. Si le produit saute aux yeux, rincer ces derniers à l'eau abondante
	Électricien installateur		Mitigeur thermostatique HighFlow		Courant marche / arrêt
	Entretien (voir pages 54)		Le débit de vidage doit être supérieur à 50 l/min.		Classification acoustique et débit (voir pages 55)
	Le fonctionnement de l'équipement de protection doit être vérifié à intervalles réguliers.		Vidage		
			Centre cuvette de douche		
			Ouvrir l'eau. / Couper l'arrivée d'eau		

 **Montage Kit de base** (voir pages 42)

 **Montage Set de finition** (voir pages 47)



Safety Notes

- ⚠️ Gloves should be worn during installation to prevent crushing and cutting injuries.
- ⚠️ The product may only be used for bathing, hygienic and body cleaning purposes.
- ⚠️ Children as well as adults with physical, mental and/or sensoric impairments must not use this product without proper supervision. Persons under the influence of alcohol or drugs are prohibited from using this product.
- ⚠️ Do not allow the streams of the shower touch sensitive body parts (such as your eyes). An adequate distance must be kept between the shower and you.
- ⚠️ The hot and cold supplies must be of equal pressures.

⚡ Electrical connection

- ⚠️ The electrical connection may only be carried out by an electrician!
- ⚠️ Pre-install voltage supply 100-240V/N/PE/50-60Hz (length: 0,3).
- ⚠️ The system must be protected via a leakage current protective device (RCD/FI) with a measurement difference current of ≤ 30 mA.
- ⚠️ The product must be connected to 4 mm² equipotential bonding (PA) to be provided by the customer.

⚡ Electrician

- ⚠️ The installation and testing work must be performed by a skilled electrician in observance of VDE 0100 part 701, IEC 60364-6 and IEC 60364-7-701 as well as EN 60335-2-105.
- ⚠️ The mains connection line must be inserted into the connection socket with double insulation

Installation Instructions

- Prior to installation, inspect the product for transport damages. After it has been installed, no transport or surface damage will be honoured.
- The pipes and the fixture must be installed, flushed and tested as per the applicable standards.
- The plumbing codes applicable in the respective countries must be observed.
- During installation of the product by qualified trained personnel, make sure that the entire fastening surface is even and smooth (no protruding seams or tile

offset), that the finish of the wall is suitable to apply the product and has no weak points.

- Observe all current and water lines when drilling!
- The performance of the waste must be of sufficient size.
- The shower may only be connected downstream of a shut-off valve or sanitary fitting.
- The product is not designed to be used with steam baths!

Technical Data

Operating pressure in front of the shower fitting:	max. 1 MPa
Recommended operating pressure:	0,3 - 0,5 MPa (1 MPa = 10 bar = 147 PSI)
Hot water temperature:	max. 60°C
Recommended hot water temp.:	42°C
safety lock:	40°C

Warning: Exceeding this temperature can cause burns!

Thermal disinfection:	max. 70°C / 4 min
Nominal voltage	100-240V AC 50-60Hz
Nominal consumption	18 W
Lights 4 x LED:	12V DC SELV 4 W
The lamp cannot be dimmed.	
Protection class	II
Protection category	IPX5

Symbol description

Do not use silicone containing acetic acid!	Water connection DN20	Wiring conduit for power supply cable
Dimensions (see page 32)	Warm water	Hot surface!
Installation example (see page 34)	Water connection DN20	Safety gloves must be worn
Operation (see page 31)	Cold water	Eye protection must be worn
Spare parts (see page 31)	Shut off valve	natural sponge
Service Replace illuminant (see page 53)	Quattro 4-Way Diverter Valve	Decalcifier (Citric acid base) Avoid contact with eyes and skin. If this product contacts your eyes, rinse thoroughly with water.
Cleaning (see page 50)	Trio 2-Way Diverter Valve with integrated Shut-off valve	Electricity on / off
Electrician	Thermostatic mixer HighFlow	Test certificate (see page 55)
Maintenance (see page 54) The proper function of this protective device must be checked at regular intervals.	Waste	
	Raindrain	
	Center shower tub	
	Turn on water / turn off water	

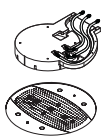

Assembly basic kit (see page 42)

Assembly Finish set (see page 47)



Indicazioni sulla sicurezza

- ⚠ Durante il montaggio, per evitare ferite da schiacciamento e da taglio bisogna indossare guanti protettivi.
- ⚠ Il prodotto deve essere utilizzato esclusivamente per fare il bagno e per l'igiene del corpo.
- ⚠ I bambini e gli adulti affetti da menomazioni fisiche, psichiche e/o sensoriali devono utilizzare il sistema doccia solo sotto sorveglianza. Il prodotto non deve essere utilizzato da persone sotto l'effetto di droghe o alcolici.
- ⚠ Bisogna evitare il contatto fra il getto della doccia e parti del corpo delicate (ad es. gli occhi). Fra il soffione ed il corpo va mantenuta una distanza sufficiente.
- ⚠ Attenzione! Compensare le differenze di pressione tra i collegamenti dell'acqua fredda e dell'acqua calda.

⚡ Allacciamento elettrico

- ⚠ Il cablaggio deve essere eseguito esclusivamente da un installatore specializzato!
- ⚠ Preinstallare l'alimentazione della tensione 100-240V/N/PE/50-60Hz (Lunghezza: 0,3 m).
- ⚠ Per protezione bisogna installare un circuito di sicurezza per correnti di guasto (RCD/ FI) con una corrente differenziale nominale di ≤ 30 mA.
- ⚠ Il prodotto deve essere collegato a un collegamento equipotenziale (PA) 4 mm² presente in loco.

⚡ Installatore elettricista

- ⚠ I lavori di installazione e di controllo vanno eseguiti da un elettricista specializzato autorizzato, in considerazione delle norme VDE 0100 Parte 701, IEC 60364-6 e IEC 60364-7-701 nonché EN 60335-2-105.
- ⚠ Il cavo di allacciamento alla rete deve essere inserito con isolamento doppio nella presa di collegamento.

Istruzioni per il montaggio

- Prima del montaggio è necessario controllare che non ci siano stati danni durante il trasporto. Una volta eseguito il montaggio, non verranno riconosciuti eventuali danni di trasporto o delle superfici.

- Montare, lavare e controllare tubature e rubinetteria rispettando le norme correnti.
- Vanno rispettate le direttive di installazione nazionali vigenti nel rispettivo paese.
- Per il montaggio del prodotto da personale specializzato qualificato bisogna fare attenzione, che la superficie di fissaggio, in tutto il campo di fissaggio, sia piana (nessuna giunzione sporgente o sfalsamento di piastrella), la costruzione della parete sia adatta al montaggio del prodotto e che non presenti alcun punto debole.
- Nel praticare i fori attenzione a non danneggiare linee elettriche ed idriche!
- Lo scarico deve essere sufficientemente dimensionato.
- La doccia deve essere collegata solo a valle di una valvola d'arresto o di un'armatura sanitaria.
- Il prodotto non è predisposto per l'impiego in combinazione con un bagno a vapore.

Dati tecnici

Pressione di servizio prima della rubinetteria:	max. 1 MPa
Pressione d'uso consigliata:	0,3 - 0,5 MPa (1 MPa = 10 bar = 147 PSI)
Temperatura dell'acqua calda:	max. 60°C
Temp. dell'acqua calda consigliata:	42°C
Blocco di sicurezza:	40°C
Avvertenza: il superamento di questa temperatura può causare delle ustioni!	
Disinfezione termica:	max. 70°C / 4 min
Tensione nominale	100-240V AC 50-60Hz
Assorbimento nominale	18 W
Lampade 4 x LED:	12V DC SELV 4 W
La lampadina non è dimmerabile.	
Classe di protezione	II
Tipo di protezione	IPX5

Descrizione simbolo

Non utilizzare silicone contenente acido acetico!	Allacciamento acqua DN20 Acqua calda	Tubo vuoto per l'alimentazione elettrica
Ingombri (vedi pagg. 32)	Allacciamento acqua DN20 Acqua fredda	Attenzione, superficie molto calda!
Esempio di installazione (vedi pagg. 34)	Rubinetto di arresto	Indossare guanti di protezione
Procedura (vedi pagg. 31)	Quattro Valvola a quattro vie	Indossare la protezione per gli occhi
Parti di ricambio (vedi pagg. 31)	Trio arresto/deviatore	spugna naturale
Servizio Sostituzione lampada (vedi pagg. 53)	Termostatico HighFlow	Decalcificatore (a base di acido citrico) Evitare il contatto con gli occhi e la pelle. Nel caso il prodotto penetra negli occhi, sciacquarlo accuratamente con acqua.
Pulitura (vedi pagg. 50)	La portata di scarico deve essere superiore a 50 l/min.	Corrente ON / OFF
Installatore elettricista	Scarico	Segno di verifica (vedi pagg. 55)
Manutenzione (vedi pagg. 54) Il dispositivo di protezione va controllato a intervalli regolari sul suo funzionamento.	Centro piatto doccia	
	X Aprire l'acqua / Chiudere l'acqua	



Montaggio corpo base (vedi pagg. 42)



Montaggio Set esterno (vedi pagg. 47)



Indicaciones de seguridad

- ⚠ Durante el montaje deben utilizarse guantes para evitar heridas por aplastamiento o corte.
- ⚠ El producto solo debe ser utilizado para fines de baño, higiene y limpieza corporal.
- ⚠ Niños, así como adultos con limitaciones corporales, mentales y/o sensoriales no deben utilizar el sistema de duchas sin vigilancia. Personas que se encuentran bajo el efecto de alcohol o drogas, no deben utilizar el sistema de duchas.
- ⚠ Debe evitarse el contacto del chorro del pulverizador con partes sensibles del cuerpo (por ej. ojos). Debe mantenerse una distancia suficiente entre pulverizador y cuerpo.
- ⚠ Grandes diferencias de presión en servicio entre agua fría y agua caliente deben equilibrarse.

Conexión eléctrica

- ⚠ ¡Solo un especialista está autorizado para llevar a cabo los trabajos de cableado!
- ⚠ Instalar previamente la alimentación de tensión 100-240V/N/PE/50-60Hz (longitud: 0,3 m).
- ⚠ La conexión debe establecerse a través de un dispositivo de protección de corriente residual (RCD/ FI) con un interruptor diferencial de corriente ≤ 30 mA.
- ⚠ El producto tiene que ser conectado a una conexión equipotencial (PA) de 4 mm² de puesta a disposición en obra.

Instalador eléctrico

- ⚠ La instalación y las pruebas solo pueden ser realizadas por técnicos electricistas cualificados, respetando las reglamentaciones de las normas VDE 0100, parte 701, IEC 60364-6 y IEC 60364-7-701, así como la norma EN 60335-2-105.
- ⚠ El cable de conexión a la red tiene que ser conectado en la toma con aislamiento doble .

Indicaciones para el montaje

- Antes del montaje se debe examinar el producto contra daños de transporte. Después de la instalación no se reconoce ningún daño de transporte o de

superficie.

- Los conductos y la grifería deben montarse, lavarse y comprobarse según las normas vigentes.
- Es obligatorio el cumplimiento de las directrices de instalación vigentes en el país respectivo.
- Durante el montaje del producto, mediante personal especializado, se debe asegurar de que la superficie de sujeción en todo el área de la fijación sea plana (sin fugas o azulejos que sobresalgan), que la estructura del muro sea adecuada para el montaje del producto y que no presente puntos débiles.
- ¡Prestar especial atención al taladrar cerca de conductos eléctricos o de agua!
- La tubería de desagüe ha de tener una dimensión suficiente.
- La roseta de ducha debe conectarse siempre a una válvula de bloqueo o a un valvulero sanitaria.
- ¡El producto no ha sido diseñado para uso en conexión con un baño de vapor!

Datos técnicos

Presión de servicio delante de la grifería:	max. 1 MPa
Presión recomendada en servicio:	0,3 - 0,5 MPa (1 MPa = 10 bar = 147 PSI)
Temperatura del agua caliente:	max. 60 °C
Temp. recomendada del agua caliente:	42 °C
Bloqueo de seguridad:	40 °C
Aviso de peligro: si se supera esta temperatura pueden provocarse quemaduras.	
Desinfección térmica:	max. 70 °C / 4 min
Tensión nominal	100-240V AC 50-60Hz
Consumo nominal	18 W
Lámparas 4 x LED:	12V DC SELV 4 W
La lámpara no es regulable.	
Clase de protección	II
Tipo de protección	IPX5

Descripción de símbolos

	No utilizar silicona que contiene ácido acético!		Conexión de agua DN20		Tubo vacío para alimentación eléctrica
	Dimensiones (ver página 32)		Agua caliente		¡Atención, superficie muy caliente!
	Ejemplos de montaje (ver página 34)		Conexión de agua DN20		Protección obligatoria de la vista
	Manejo (ver página 31)		Agua fría		Protección obligatoria de las manos
	Repuestos (ver página 31)		Llave de paso		España natural
	Reparación Cambio de luminarias (ver página 53)		Quattro válvula de 4 vías		Descalcificador (a base de ácido cítrico)
	Limpiar (ver página 50)		Trio llave de paso y distribuidor		Evitar el contacto con ojos y piel. En caso de que el producto entre en contacto con los ojos, debe lavarlos muy bien con agua.
	Instalador eléctrico		Termostato HighFlow		Corriente on / off
	Mantenimiento (ver página 54)		El caudal de desagüe debe ser como mínimo de 50 l/min		Marca de verificación (ver página 55)
	El dispositivo de protección debe ser sometido a un control de funcionamiento con regularidad.		> 50 l/min		
			Desagüe		
			Raindrain		
			Centro la plato de ducha		
			X		
			Abrir el agua / Cerrar el agua		



Montaje Kit base (ver página 42)



Montaje Embellecedor exterior (ver página 47)



Veiligheidsinstructies

- ⚠ Bij de montage moeten ter voorkoming van knel- en snijwonden handschoenen worden gedragen.
- ⚠ Het product mag alleen voor het wassen, hygiënische doeleinden en voor de lichaamreiniging worden gebruikt.
- ⚠ Kinderen en volwassenen met lichamelijke, geestelijke en/of sensorische beperkingen mogen het douchesysteem niet zonder toezicht gebruiken. Personen onder invloed van alcohol of drugs mogen het douchesysteem niet gebruiken.
- ⚠ Het contact van de douchestraal met gevoelige lichaamsdelen (bijv. ogen) moet worden voorkomen. Er moet voldoende afstand tussen douche en lichaam aangehouden worden.
- ⚠ Grote drukverschillen tussen de koud- en warmwatertoevoer dienen vermeden te worden.

Elektrische aansluiting

- ⚠ De elektrische aansluiting mag alleen door een vakman worden uitgevoerd!
- ⚠ Spanningsvoorziening 100-240V/N/PE/50-60Hz (lengte: 0,3 m) vooraf installeren.
- ⚠ Deze moet middels een 2-polige FI-schakelaar met 30mA afgezekerd worden.
- ⚠ Het product moet aangesloten worden aan een potentiaalvereffening van het gebouw (PA) van 4 mm².

Electro-installateur

- ⚠ De installatie- en controlewerkzaamheden moeten uitgevoerd worden door een geautoriseerde elektricien die rekening houdt met de normen VDE 0100 Deel 701, IEC 60364-6, IEC 60364-7-701 en EN 60335-2-105.
- ⚠ Het netsnoer moet dubbel geïsoleerd in de contactd os geleid worden.

Montage-instructies

- Vóór de montage moet het product gecontroleerd worden op transportschade. Na de inbouw wordt geen transport- of oppervlakteschade meer aanvaard.
- De leidingen en armaturen moeten gemonteerd, gespoeld en gecontroleerd worden volgens de geldige normen.
- De in de overeenkomstige landen geldende installatierichtlijnen moeten nageleefd worden.

- Bij de montage van het product door gekwalificeerd vakpersoneel moet erop gelet worden dat het montagevlak in het volledige bereik van de bevestiging vlak is (geen uitstekende voegen of verspringende tegels), dat de wand geschikt is voor de montage van het product en geen zwakke plaatsen vertoont.
- Bij het boren in stroom- en waterleidingen
- De afvoercapaciteit moet voldoende gedimensioneerd worden.
- De douche mag enkel aangesloten worden na een afsluitklep of een sanitaire kraan.
- Het product is niet voorzien voor gebruik in combinatie met een stoombad!

Technische gegevens

Stroomdruk voor de kraan: max. 1 MPa
 Aanbevolen werkdruk: 0,3 - 0,5 MPa
 (1 MPa = 10 bar = 147 PSI)

Temperatuur warm water: max. 60 °C
 Aanbevolen warm water temp.: 42 °C
 Veiligheidsmechanisme: 40 °C

Waarschuwing: Een overschrijding van die temperatuur kan brandwonden veroorzaken!

Thermische desinfectie: max. 70 °C / 4 min
 Nominale spanning: 100-240V AC 50-60Hz
 Opgenomen vermogen: 18 W
 Lampjes 4 x LED: 12V DC SELV 4 W
 De lamp is niet dimbaar.
 Beschermingsklasse: II
 Beveiligingsklasse: IPX5

Symboolbeschrijving

	Gebruik geen zuurhoudende silicone!		Wateraansluiting DN20		Loze leiding voor stroom toevoer
	Maten (zie blz. 32)		Warm water		Let op: heet!
	Montagevoorbeelden (zie blz. 34)		Wateraansluiting DN20		Veiligheidshandschoenen verplicht
	Bediening (zie blz. 31)		Koud water		Oogbescherming verplicht
	Service onderdelen (zie blz. 31)		Inbouwstopkraan		Natuurzwam
	Service Verlichting vervangen (zie blz. 53)		Quattro 4-weg omstelkraan		Ontkalker (citroenzuurbasis) Contact met huid en ogen vermijden. Indien het product in de ogen terecht komt, moet het grondig met water uitgespoeld worden.
	Reinigen (zie blz. 50)		Trio stop- en omstelkraan		
	Electro-installateur		Trio HighFlow		De afvoercapaciteit moet meer dan 50 l/min bedragen.
	Onderhoud (zie blz. 54) De veiligheidsinrichting moet regelmatig op functionaliteit gecontroleerd worden.		Afvoer		Stroom aan / uit
			Raindrain X		Keurmerk (zie blz. 55)
			Midden Douchebak		
			Hoofdkraan openen / Water afsluiten		



Montage Basisset (zie blz. 42)



Montage Kleurset (zie blz. 47)



Sikkerhedsanvisninger

- ⚠ Ved monteringen skal der bruges handsker for at undgå kvæstelser og snitsår.
- ⚠ Produktet må kun bruges til bade-, hygiejne og kropsurengøringsformål.
- ⚠ Børn som også voksne med fysiske, mentale og / eller sensoriske begrænsninger må ikke bruge brusersystemet uden opsyn. Personer som er under indflydelse af alkohol eller narkotika må ikke bruge brusersystemet.
- ⚠ Bruserstrålens kontakt med sensitive områder (f.eks. øjne) skal undgås. Der skal være en tilstrækkelig afstand mellem bruseren og kroppen.
- ⚠ Større trykforskelle mellem koldt og varmt vand bør udjævnes.

El-tilslutning

- ⚠ Ledningsarbejde må kun foretages af en fagmand!
- ⚠ Forinstallér spændingsforsyning 100-240V/N/PE/50-60Hz (længde: 0,3 m).
- ⚠ Sikringen skal køre over en fejlstrømsikring (HFI) med en fejlstrømsdifference ≤ 30 mA.
- ⚠ Produktet skal tilsluttes til en potentialudligning (PA) 4 mm².

El-installatør

- ⚠ Installeringen og afprøvningen skal gennemføres af en godkendt el-installatør iht. VDE 0100 part 701, IEC 60364-6 og IEC 60364-7-701 samt EN 60335-2-105.
- ⚠ Nettildslutningsledningen skal føres dobbeltisoleret ind i tilslutningsdåsen.

Monteringsanvisninger

- Før monteringen skal produktet kontrolleres for transportskader. Efter monteringen godkendes transportskader eller skader på overfladen ikke længere.
- Ledningerne og armaturerne skal monteres, skylles og kontrolleres iht. de gældende standarder.
- Installationsbestemmelserne, der gælder i det enkelte land, skal overholdes.
- Ved montering af produktet igennem kvalificerede fagfolk skal der holdes øje med, at fastgørelsesoverfladen er plan i alle områder hvor produktet monteres (ingen fremragende fuger eller fliseforskydninger), at væggene er velegnet til monteringen af produktet og ikke har svare områder.
- Pas på strøm- og vandledninger ved boring!

- Afløbet skal være i en tilstrækkelig størrelse.
- Bruseren må kun tilsluttes efter en afspærringsventil eller et sanitæramatur.
- Dette produkt er ikke beregnet til anvendelse i forbindelse med et dampbad!

Tekniske data

Betjeningstryk før armaturet:	max. 1 MPa
Anbefalet driftstryk:	0,3 - 0,5 MPa (1 MPa = 10 bar = 147 PSI)
Varmtvandstemperatur:	max. 60 °C
Anbefalet varmtvandstemperatur:	42 °C
Sikkerhedsspærre:	40 °C
Advarsel: Hvis temperaturen overskrides kan det føre til forbrændinger!	
Termisk desinfektion:	max. 70 °C / 4 min
Mærkespænding	100-240V AC 50-60Hz
Nominelt forbrug	18 W
Lamper 4 x LED:	12V DC SELV 4 W
Lyskilden kan ikke dæmpes.	
Beskyttelsesklasse	II
Kapslingsklasse	IPX5

Symbolbeskrivelse

	Der må ikke benyttes eddikesyreholdig silikone!		Vandtilslutning DN20		Tomrør til strømforsyning
	Målene (se s. 32)		Varmt vand		Varm overflade!
	Monteringseksempler (se s. 34)		Vandtilslutning DN20		Beskyttelseshandsker påbudt
	Brugsanvisning (se s. 31)		Kold vand		Øjenværn påbudt
	Reserve dele (se s. 31)		Afspæringsventil		Natursvamp
	Service Udskifte lyskilden (se s. 53)		Quattro 4-vejs ventil		Afkalkningsmiddel (citronsyre-basis) Undgå kontakt med øjne og huden. Skyl grundigt med vand, hvis produktet kommer i øjnene.
	Rengøring (se s. 50)		Trio afspæringsventil og omskifter		Strøm til / fra
	El-installatør		Trio High Flow		Godkendelse (se s. 55)
	Service (se s. 54) Beskyttelsesanordningen skal kontrolleres i regelmæssige afstande for funktion.		Termostat HighFlow		
			Afløbskapaciteten skal være mere end 50 l/min.		
			Afløb		
			Midt brusekar		
			Tænd for vandet / Luk for vandet		



Montering Basis-sæt (se s. 42)



Montering Kappesæt (se s. 47)



Wskazówki bezpieczeństwa

- ⚠ Aby uniknąć zranień na skutek zgniecenia lub przecięcia, podczas montażu należy nosić rękawice ochronne.
- ⚠ Produkt może być używany tylko do kąpieli, higieny i czyszczenia ciała.
- ⚠ Zarówno dzieci, jak i dorośli z fizycznymi, psychicznymi i/lub sensorycznymi ograniczeniami nie mogą korzystać z prysznica bez opieki. Osoby znajdujące się pod wpływem alkoholu lub narkotyków nie mogą korzystać z prysznica.
- ⚠ Należy unikać kontaktu strumienia wypływającego z głowicy z wrażliwymi częściami ciała (np. oczami). Należy zachowywać odpowiednią odległość pomiędzy głowicą a ciałem.
- ⚠ Znaczne różnice ciśnień na dopływach ciepłej i zimnej wody muszą zostać wyrównane.

Przyłącze elektryczne

- ⚠ Podłączenie elementów elektrycznych może być przeprowadzone jedynie przez fachowca elektryka!
- ⚠ Zainstalować zasilanie napięciowe 100-240V/N/PE/50-60Hz (Długość: 0,3 m).
- ⚠ Zabezpieczenie instalacji musi mieć miejsce przy użyciu zabezpieczenia różnicowego (RCD/ FI) z różnicą pomiarów wynoszącą ≤ 30 mA.
- ⚠ Produkt należy podłączyć do ekwipotencjalizacji (PA) 4 mm² udostępnionej przez klienta.

Elektryk instalator

- ⚠ Prace instalacyjne i kontrolne mogą być przeprowadzane jedynie przez wykwalifikowanego elektryka, przestrzegając przepisów z VDE 0100 część 701, IEC 60364-6 i IEC 60364-7-701 oraz EN 60335-2-105.
- ⚠ Przewód sieciowy musi być wyposażony w podwójną izolację i wprowadzony do puszki przyłączeniowej.

Wskazówki montażowe

- Przed montażem należy skontrolować produkt pod kątem szkód transportowych. Po montażu nie widać żadnych szkód transportowych ani szkód na powierzchni.
- Przewody i armatura muszą być montowane, płukane i kontrolowane według obowiązujących norm.

- Należy przestrzegać wytycznych instalacyjnych obowiązujących w danym kraju.
- Montaż produktu musi być wykonany przez wykwalifikowanego fachowca. Powierzchnia w miejscu montażu musi być równa (bez uskoków wzgl. wzajemnie przesuniętych płytek). Ściana w miejscu montażu musi być stabilna. Dołożone w komplecie śruby i kołki rozporowe są przeznaczone do betonu.
- Podczas wiercenia uważać na instalacje elektryczne i wodne!
- Odpływ musi mieć wystarczającą wydajność.
- Prysznic można podłączyć tylko po użyciu zaworu odcinającego lub armatury sanitarnej.
- Produkt nie jest przewidziany do zastosowania w łaźni parowej!

Dane techniczne

Ciśnienie robocze przed armaturą: maks. 1 MPa
 Zalecane ciśnienie robocze: 0,3 - 0,5 MPa
 (1 MPa = 10 bary = 147 PSI)

Temperatura wody gorącej: maks. 60 °C
 Zalecana temperatura wody gorącej: 42 °C
 Blokada bezpieczeństwa: 40 °C

Wskazówka ostrzegawcza: Przekroczenie tej temperatury może prowadzić do oparzeń!

Dezynfekcja termiczna: maks. 70 °C / 4 min
 Napięcie znamionowe: 100-240V AC 50-60Hz
 Nominalny pobór mocy: 18 W
 Lampy 4 x LED: 12V DC SELV 4 W
 Żarówki nie można ściemnić.
 Klasa ochrony: II
 Stopień ochrony: IPX5

Opis symbolu

 Nie stosować silikonów zawierających kwas octowy!

 **Wymiary** (patrz strona 32)

 **Przykłady montażowe** (patrz strona 34)

 **Obsługa** (patrz strona 31)

 **Części serwisowe** (patrz strona 31)

 **Serwisowy Wymienić żarówki** (patrz strona 53)

 **Czyszczenie** (patrz strona 50)

 **Elektryk instalator**

 **Konserwacja** (patrz strona 54)
 Urządzenie ochronne musi być sprawdzane w regularnych odstępach czasu pod kątem właściwego działania.

 Podłączenie wody DN20

 Ciepła woda

 Podłączenie wody DN20

 Zimna woda

 Zawór podtynkowy

 Regulator czterodrożny Quattro

Quattro

 Zawór odcinający i regulacyjny Trio Universal

Trio

 Termostat HighFlow

HighFlow

 Wydajność odpływu musi być wyższa niż 50 l/min.

> 50 l/min

 Odpływ

Raindrain

 Środek brodzika

X

 Otworzyć wodę / Zakreślić wodę



 Rurka kablowa na doprowadzenie instalacji elektrycznej

 Uwaga na gorącą powierzchnię!

 Nosić rękawice ochronne

 Nosić okulary ochronne

 **Gąbka naturalna**

 **Środek odkamieniający** (na bazie kwasu cytrynowego)
 Unikać kontaktu z oczami i skórą. Jeżeli produkt dostanie się do oczu, należy je gruntownie wypłukać wodą.

 Wł. / wytł. prąd

 **Znak jakości** (patrz strona 55)



Montaż Zestaw podstawowy (patrz strona 42)



Montaż Elementy zewnętrzne (patrz strona 47)



Bezpečnostní pokyny

- ⚠ Pro zabránění řezným zraněním a pohmožděninám je nutné při montáži nosit rukavice.
- ⚠ Produkt smí být používán pouze ke koupání a za účelem tělesné hygieny.
- ⚠ Děti a dospělí osoby s tělesným, duševním a / nebo smyslovým postižením nesmí produkt používat bez dozoru. Osoby pod vlivem alkoholu nebo drog nesmí produkt používat.
- ⚠ Je nutné zabránit kontaktu vodních paprsků sprchy s měkkými částmi těla (např. očima). Je nutné dodržovat dostatečný odstup mezi sprchou a tělem.
- ⚠ Je nutné vyrovnat velké rozdíly tlaku mezi přípoji studené a teplé vody.

Elektrické připojení

- ⚠ Elektroinstalace smí být provedena jen kvalifikovaným elektrikářem!
- ⚠ Zdroj napětí 100-240V/N/PE/50-60Hz (délka: 0,3 m) předinstalovat.
- ⚠ Přívod musí být chráněn proudovým chráničem pro chybový proud (RCD/ FI) s mírným rozdílovým proudem ≤ 30 mA.
- ⚠ Produkt musí být připojen k vyrovnání potenciálu (PA) 4 mm² nainstalovanému provozovatelem.

Elektroinstalatér

- ⚠ Instalační práce a přezkoušení musí být provedeno autorizovaným elektrotechnickým odborníkem za zohlednění směrnice VDE 0100, část 701, IEC 60364-6 a IEC 60364-7-701 a také EN 60335-2-105.
- ⚠ Připojovací síťové vedení musí být zavedeno do krabic přípojky tak, aby bylo dvojitě odizolované .

Pokyny k montáži

- Před montáží je třeba produkt zkontrolovat, zda nebyl při transportu poškozen. Po zabudování nebudou uznány žádné škody způsobené transportem nebo poškození povrchu.
- Vedení a armatura musí být namontovány, propláchnuty a otestovány podle platných norem.
- Je třeba dodržovat montážní pravidla platné v dané zemi.
- Při montáži produktu kvalifikovanou osobou je třeba dbát na to, aby byla upevňovací plocha v celé oblasti upevnění rovná (žádné vyčnívající spáry nebo

zapuštění obkladů), aby struktura stěny byla vhodná pro montáž produktu a neměla žádná slabá místa.

- Při vrtání dejte pozor na elektrická vedení a vodovodní potrubí!
- Propustnost odpadu musí být dostatečně dimenzována.
- Sprcha smí být připojena pouze za uzavíracím ventilem nebo sanitární armaturou.
- Výrobek není určen k použití ve spojení s parní lázní!

Technické údaje

Provozní tlak před armaturou: max. 1 MPa
 Doporučený provozní tlak: 0,3 - 0,5 MPa
 (1 MPa = 10 bar = 147 PSI)

Teplota horké vody: max. 60 °C
 Doporučená teplota horké vody: 42 °C
 Bezpečnostní zámek: 40 °C

Varování: Překročení této teploty může vést k popáleninám!

Teplotná desinfekce: max. 70 °C / 4 min
 100-240V AC 50-60Hz
 Jmenovitý proud: 18 W
 Svítidla 4 x LED: 12V DC SELV 4 W

Světlo není regulovatelné.
 Třída ochrany II
 Třída krytí IPX5

Popis symbolů

	Nepoužívat silikon s obsahem kyseliny octové!		Připojení vody DN20		Instalační trubka pro napájení elektrickým proudem
	Rozměry (viz strana 32)		Teplá voda		Pozor, horký povrch!
	Příklady montáže (viz strana 34)		Připojení vody DN20		Noste ochranné rukavice
	Ovládání (viz strana 31)		Studená voda		Noste ochranné brýle
	Servisní díly (viz strana 31)		Podomítkový uzavírací ventil		Přírodní mořská houba
	Servisní Výměna svítidel (viz strana 53)		Quattro čtyřcestné přestavování		Odvápňovač (báze kyseliny citrónové)
	Čištění (viz strana 50)		Trio Universal - Uzavírací a přepínací ventil		Zabraňte styku s pokožkou a očima. Zasáhne-li výrobek oči, důkladně je vypláchněte vodou.
	Elektroinstalatér		Trio HighFlow		Elektrický proud ZAP / VYP
	Údržba (viz strana 54)		Termostat HighFlow		Zkušební značka (viz strana 55)
	Ochranné zařízení musí být v pravidelných intervalech kontrolováno ohledně funkčnosti.		Odtokový výkon musí být vyšší než 50 l/min.		
			Odtok		
			Raindrain		
			X		
			Sřřed sprchové vany		
			Vodu zapojit / Vodu odpojit		



Montáž základní souprava (viz strana 42)

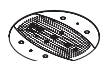

Montáž Vrchní sada (viz strana 47)

**Bezpečnostné pokyny**

- ⚠ Pri montáži musíte nosiť rukavice, aby ste predišli pomliaždeninám a rezným poraneniam.
- ⚠ Produkt sa smie používať len na kúpanie a telesnú hygienu.
- ⚠ Produkt nesmú bez dozoru používať deti, ako aj dospelé osoby s telesným, duševným a/alebo zmyslovým postihnutím. Produkt nesmú používať ani osoby, ktoré sú pod vplyvom alkoholu alebo drog.
- ⚠ Vyhýbajte sa kontaktu vodného lúča sprchy s citlivými miestami tela (napr. oči). Dodržiavajte dostatočnú vzdialenosť medzi sprchou a telom.
- ⚠ Veľké rozdiely v tlaku medzi prípojkami studenej a teplej vody musia byť vyrovnané.

Elektrické pripojenie

- ⚠ Elektroinštalácia môže byť vykonaná len kvalifikovaným elektrikárom!
- ⚠ Predinštalujte napájanie napätím 100-240V/N/PE/50-60Hz (dĺžka: 0,3 m).
- ⚠ Prívod musí byť chránený prúdovým chráničom (RCD/FI) pre chybový prúd s merným rozdielovým prúdom ≤ 30 mA.
- ⚠ Výrobok sa musí pripojiť na vyrovnanie potenciálov (PA) 4 mm² prítomné zo strany stavby.

Elektroinštalatér

- ⚠ Inštaláčne a skúšobné práce musí vykonávať len autorizovaný elektrikár pri zohľadnení noriem VDE 0100 časť 701, IEC 60364-6 a IEC 60364-7-701, ako aj EN 60335-2-105.
- ⚠ Sieťové pripojné vedenie sa musí viesť do prípojnej kábelnice s dvojistou izoláciou

Pokyny pre montáž

- Pred montážou musíte produkt skontrolovať, či nebol počas transportu poškodený. Po zabudovaní nebudú uznané žiadne škody spôsobené transportom alebo poškodenia povrchu.
- Ledningarna och blandaren måste monteras, spolás igenom och kontrolleras enligt de gällande normerna.
- Je potrebné dodržiavať smernice o inštalácii, ktoré sú práve teraz platné v krajinách.

- Pri montáži produktu kvalifikovanou osobou treba dávať pozor na to, aby bola upevňovacia plocha v celej oblasti upevnenia rovná (žiadne vyčnievajúce medzery alebo zapustenia obkladov), aby štruktúra steny bola vhodná pre montáž produktu a nemá žiadne slabé miesta.
- Pri vŕtaní dajte pozor na elektrické vedenia a vodovodné potrubia!
- Pripustnosť odpadu musí byť dostatočne dimenzovaná.
- Sprchu je možné napojiť len na uzatvárací ventil alebo na sanitárnu armatúru.
- Výrobok nie je vhodný na použitie v spojení s parným kúpeľom!

Technické údaje

Prevádzkový tlak pred armatúrou: max. 1 MPa
Doporučený prevádzkový tlak: 0,3 - 0,5 MPa
(1 MPa = 10 bar = 147 PSI)

Teplota teplej vody: max. 60 °C
Doporučená teplota teplej vody: 42 °C
Bezpečnostný zámok: 40 °C

Varovanie: Prekročenie tejto teploty môže viesť k popáleninám!

Termická dezinfekcia: max. 70 °C / 4 min
Menovité napätie: 100-240V AC 50-60Hz
Menovitý príkon: 18 W
Svietidlá 4 x LED: 12V DC SELV 4 W
Osvetľovací prostriedok je stmievateľný.
Trieda ochrany: II
Trieda ochrany: IPX5

Popis symbolov

	Nepoužívať silikón s obsahom kyseliny octovej!		Pripojenie vody DN20		Inštaláčna rúrka elektrického napájania
	Rozmery (viď strana 32)		Teplá voda		Pozor, horúci vzduch!
	Príklady montáže (viď strana 34)		Pripojenie vody DN20		Noste ochranné rukavice
	Obsluha (viď strana 31)		Studená voda		Noste ochranné okuliare
	Servisné diely (viď strana 31)		Podomietkový uzatvárací ventil		Prírodná morská huba
	Servisná výmena svietidiel (viď strana 53)		Quattro štvorcestné prestavenie		Odvápňovač (báza kyseliny citrónovej) Zabráňte styku s pokožkou a očami. Ak produkt zasiahne oči, dôkladne ich vypláchnite vodou.
	Čistenie (viď strana 50)		Trio univerzálny uzatvárací a prestavovací ventil		Výkon odtoku musí byť vyšší ako 50 l/min.
	Elektroinštalatér		Trio HighFlow		Odtok
	Údržba (viď strana 54) Funkčnosť ochranného zariadenia sa musí kontrolovať v pravidelných časových intervaloch.		Raindrain X		Stred sprchovej vane
			Zapojiť vodu / Odpojiť vodu		Zap./vyp. prúd
					Osvedčenie o skúške (viď strana 55)

**Montáž základná súprava** (viď strana 42)**Montáž Vrchná sada** (viď strana 47)



安全技巧

- △ 装配时为避免挤压和切割受伤，必须戴上手套。
- △ 本产品只允许作为洗浴、卫生和洁身之用。
- △ 不得让儿童和肢体、精神和/或意识有障碍的成人在不受监管的情况下使用淋浴系统。受酒精或毒品影响的人员不得使用淋浴系统。
- △ 必须避免让身体敏感部位（如眼睛）接触到莲蓬头喷水。必须保持莲蓬头与人头之间有足够距离。
- △ 冷热水管间过大的压力差必须予以平衡。

⚡ 电气连接

- △ 电气接口只能由电气专业人员进行操作！
- △ 预安装电源电压 100-240V/N/PE/50-60Hz（长度：0.3 m）。
- △ 保险装置必须是额定电流 ≤ 30 mA 的故障电流保护装置。
- △ 产品必须连接施工方现有的电位补偿(PA) 4 mm²。

⚡ 电气安装人员

- △ 安装和检查工作由有资质的电气专业人员按照德国电气工程协会VDE 0100标准中第701项和国际电工委员会 IEC 60364-6项和国际电工委员会 IEC 60364-7-701 标准以及欧洲标准60335-2-105执行。
- △ 必须使电源线双重绝缘  并插入接线盒。

安装提示

- 安装前必须检查产品是否受到运输损害。 安装后将不认可运输损害或表面损伤。
- 管道和阀门必须根据通用标准进行安装、冲洗和检查。
- 请遵守当地国家现行的安装规定。
- 由有资格的专业人员进行产品安装时请注意：在所有加固区域中，加固表面是否平整（无突出的接缝或瓷砖），墙体结构是否适合产品安装且未显露出任何缺点。
- 钻孔时请注意电线和水管！
- 废水管的性能必须具有充足的尺寸。
- 该花洒仅允许连接在卫浴龙头或截止阀之后。
- 本产品并非设计来与蒸气浴连接使用！

技术参数

花洒接头前方的操作压力:	最大 1 MPa
推荐工作压力:	0,3 - 0,5 MPa
	(1 MPa = 10 bar = 147 PSI)
热水温度:	最大 60°C
推荐热水温度:	42°C
安全止动器:	40°C
警告: 温度过高会引发燃烧危险!	
热力消毒:	最大 70°C / 4 分钟
额定电压	100-240V AC 50-60Hz
额定输入	18 W
灯 4 x LED:	12V DC SELV 4 W
灯具不可调光。	
保护等级	II
保护等级	IPX5

符号说明

	请勿使用含有乙酸的硅胶！		水连接 DN20		电源线布线导管
	大小 (参见第页 32)		热水		热表面！
	安装示意 (参见第页 34)		水连接 DN20		配戴保护手套
	操作 (参见第页 31)		冷水		配戴护眼用具
	备用零件 (参见第页 31)		截止阀		天然海绵
	备用零 更换灯具 (参见第页 53)		Quattro 四通转换器		柔软剂 (柠檬酸) 避免眼睛和皮肤接触。如该产品不慎进入眼睛，立即用清水彻底冲洗。
	清洗 (参见第页 50)		通用的三通截止阀和换向阀		
	电气安装人员		Trio 恒温龙头 HighFlow		
	保养 (参见第页 54) 必须定期检查保护装置的功能。		排水功率必须大于 50 l/min。		
			> 50 l/min		
			排水口		电流 接通/断开
			Raindrain 中心淋浴盆		检验标记 (参见第页 55)
			X 调节水 / 关闭水流		
					

 安装 基础套件 (参见第页 42)

 安装 加工件 (参见第页 47)



Указания по технике безопасности

- ⚠ Во время монтажа следует надеть перчатки во избежание прищемления и порезов.
- ⚠ Изделие разрешается использовать только в гигиенических целях: для принятия ванны и личной гигиены.
- ⚠ Дети, а также взрослые с физическими, умственными и/или сенсорными недостатками должны пользоваться изделием только под присмотром. Запрещается пользоваться изделием в состоянии алкогольного или наркотического опьянения.
- ⚠ Не допускайте попадания струи воды из разбрызгивателя на чувствительные части тела (например, на глаза). Разбрызгиватель следует устанавливать на достаточном расстоянии от тела.
- ⚠ донного клапа. Перед установкой смесителя необходимо регулировочными кранами выровнять давление холодной и горячей воды при помощи вентилей регулирующих подачу воды в квартиру.

Электроподключение

- ⚠ Электрическое подключение разрешается выполнять только специалисту-электрику!
- ⚠ Питание 100-240В/Н/РЕ/50-60Гц (длина: 0,3 м) установить предварительно.
- ⚠ Требуется организовать защиту с помощью устройства защитного отключения (выключателя дифференциального тока) с уставкой дифференциального тока ≤ 30 мА.
- ⚠ Изделие нужно подключить к выравнивателю потенциалов (РА) 4 мм², предусмотренному заказчиком.

Электромонтер

- ⚠ Установочные и проверочные работы проводятся специалистами-электриками, имеющими допуск к работе, с соблюдением VDE 0100, часть 701, IEC 60364-6, IEC 60364-7-701 и EN 60335-2-105.
- ⚠ Провод для подключения к сети нужно вставить в розетку с двойной изоляцией

Указания по монтажу

- Перед монтажом следует проверить изделие на предмет повреждений при

перевозке. После монтажа претензии о возмещении ущерба за повреждения при перевозке или повреждения поверхностей не принимаются.

- Трубы и арматура должны быть установлены, промыты и проверены в соответствии с действующими нормами.
- Необходимо соблюдать требования по монтажу, действующие в соответствующих странах.
- Во время монтажа изделия квалифицированным персоналом поверхность крепления должна быть ровной по всей области крепления (не допускайте выступающих стыков или перекоса облицовочной плитки); для монтажа изделия следует использовать подходящую стену достаточной прочности.
- При сверлении обратить внимание на проложенные трубы или электрический кабель!
- Слив должен иметь достаточную производительность.
- Источник разбрызгивания должен подсоединяться только после запорного клапана или санитарной арматуры.
- Изделие не предназначено для использования в паровой бане!

Технические данные

Рабочее давление в смесителе:	не более. 1 МПа
Рекомендуемое рабочее давление:	0,3 - 0,5 МПа (1 МПа = 10 bar = 147 PSI)
Температура горячей воды:	не более. 60°C
Рекомендуемая темп. гор. воды:	42°C
Предохранительный фиксатор:	40°C
Предупреждение. Превышение этой температуры может привести к ожогам!	
Термическая дезинфекция:	не более. 70°C / 4 мин
Номинальное напряжение	100-240V AC 50-60Hz
Номинальное потребление	18 W
Светильники 4 x LED:	12V DC SELV 4 W
Яркость лампочки не регулируется.	
Степень защиты	II
Тип защиты	IPX5

Описание символов

	Не применяйте силикон, содержащий уксусную кислоту.		Подключение воды DN20		Полая трубка для электропроводки
	Размеры (см. стр. 32)		Теплая вода		Осторожно! Горячая поверхность!
	варианты установки (см. стр. 34)		Подключение воды DN20		Носите защитные перчатки
	Эксплуатация (см. стр. 31)		Холодная вода		Носите средства защиты глаз
	Комплект (см. стр. 31)		Скрытый вентиль		Губка из натурального волокна
	Гарнитурный Замена источника света (см. стр. 53)		Четырехходовой переключатель Quattro		Удалитель накипи (на основе лимонной кислоты) Избегайте контакта с глазами и кожей. При попадании продукта в глаза, тщательно промойте их водой.
	Очистка (см. стр. 50)		Трехходовой запорный и переключающий вентиль Trio Universal		
	Электромонтер		Термостат HighFlow		
	Техническое обслуживание (см. стр. 54) Защитное устройство подвергают регулярной проверке на предмет функционирования.		Слив должен иметь производительность более 50 л/мин.		
			Слив		Ток вкл. / выкл.
			Sередина душевой ванны		Знак технического контроля (см. стр. 55)
			откройте воду / Закройте воду		



Монтаж Основной комплект (см. стр. 42)



Монтаж Наружная часть (см. стр. 47)





Biztonsági utasítások

- ⚠ A szerelésnél a zúzódások és vágási sérülések elkerülése érdekében kesztyűt kell viselni.
- ⚠ A terméket csak fürdéshez, mosakodáshoz, és egészségügyi tisztálkodáshoz szabad használni.
- ⚠ Gyermekek, valamint testileg, szellemileg fogyatékos és / vagy érzékelésben korlátozott személyek nem használhatják felügyelet nélkül a terméket. Alkohol és kábítószer befolyása alatt álló személyek nem használhatják a terméket.
- ⚠ Kerülni kell a zuhanyugár érintkezését érzékeny testrészekkel (pl. szemek). Be kell tartani a megfelelő távolságot a zuhanyfej és a test között.
- ⚠ A hidegvíz- és a melegvíz-csatlakozások közötti nagy nyomáskülönbséget kikkel egyenlíteni!

⚡ Elektromos csatlakozás

- ⚠ Az elektromos hálózathoz való csatlakoztatást csak szakember végezheti el!
- ⚠ A feszültségellátást 100-240V/N/PE/50-60Hz (hosszúság: 0,3 m) előre létre kell hozni.
- ⚠ A biztosítást egy hibaáram-mentesítő (RCD/ FI) útján, egy 30 mA-nál kisebb hálózati váltóáram segítségével kell megvalósítani.
- ⚠ A terméket egy az építkezésen meglévő potenciálkiegyenlítéshez (PA) 4 mm² kell csatlakoztatni.

⚡ Elektromos szakember

- ⚠ Az installációs és ellenőrző munkákat jóváhagyott elektromos szakembernek kell elvégezni, a VDE 0100 701, IEC 60364-6 része és az IEC 60364-7-701, valamint az EN 60335-2-105 figyelembevételével.
- ⚠ A hálózati csatlakozóvezetékét duplán szigetelve kell   csatlakozódobozba bevezetni.

Szerelési utasítások

- A szerelés előtt ellenőrizni kell, hogy a terméknek nincs-e szállítási sérülése. Beépítés után a szállítási- vagy felületi sérüléseket nem ismerik el.
- A vezetékeket és a csaptelepet az érvényes szabványoknak megfelelően kell felszerelni, öblíteni és ellenőrizni
- Az egyes országokban érvényes installációs irányelveket be kell tartani.

- A termék képzett szakember általi felszerelése esetén ügyelni kell arra, hogy a rögzítési felület teljesen sima legyen (ne legyen kiálló fuga vagy csempé), a fal szerkezete a termék felszerelésére alkalmas legyen, és ne legyen gyenge pontja.
- Fúrás esetén ügyelni kell az áram- és vízvezetésekre!
- A kifolyási teljesítményt megfelelően kell dimenzionálni.
- A zuhanyt csak zárószelep vagy szaniter csaptelep után szabad bekötni.
- A terméket nem gőzfürdővel együttes használatra tervezték!

Műszaki adatok

Üzemi nyomás a csaptelep előtt:
Ajánlott üzemi nyomás:

max. 1 MPa
0,3 - 0,5 MPa
(1 MPa = 10 bar = 147 PSI)

Forróvíz hőmérséklet:
Forróvíz javasolt hőmérséklete:
Biztonsági zár:

max. 60°C
42°C
40°C

Figyelmeztetés: Ezen hőmérséklet túllépése égési sérüléshez vezethet!

Termikus fertőtlenítés:
Névleges feszültség
Névleges felvétel
Lámpák 4 x LED:
A lámpa nem halványítható.
Védelmi osztály
Védettség

max. 70°C / 4 perc
100-240V AC 50-60Hz
18 W
12V DC SELV 4 W

II
IPX5

Szimbólumok leírása

 Ne használjon ecetsavtartalmú szilikont!

 **Méretet** (lásd a oldalon 32)

 **Szerelési példák**
(lásd a oldalon 34)

 **Használat** (lásd a oldalon 31)

 **Tartozékok** (lásd a oldalon 31)

 **Szervíz Világítótest cseréje**
(lásd a oldalon 53)

 **Tisztítás** (lásd a oldalon 50)

 **Elektromos szakember**

 **Karbantartás** (lásd a oldalon 54)
A védőberendezés működését rendszeres időközönként ellenőrizni kell.

 Vízcsatlakozás DN20

 Melegvíz

 Vízcsatlakozás DN20

 Hidegvíz

 Falsík alatti szelep

 Quattro négy-utas átalakító

 Trio univerzális záró- és váltószelep

 Trio

 Trio univerzális záró- és váltószelep

 Trio

 HighFlow

 Termosztát HighFlow

 A lefolyó teljesítményének 50l/percnél magasabbnak kell lenni

 > 50 l/min

 Lefolyó

 Raindrain

 Zuhanytálca közepe

 X

 Nyissuk meg a vizet. / Zárjuk el a vizet

 Nyissuk meg a vizet. / Zárjuk el a vizet

 Bergmannscső a hálózati kapcsolódáshoz

 Vigyázat! Forró felületek!

 Viseljen védkesztyűt

 Viseljen szemvédőt

 Viseljen szemvédőt

 Természetes szivacs

 Természetes szivacs

 Vízköoldó (citromsav alapú)

 Vízköoldó (citromsav alapú)

 Kerülje a szemmel és bőrrel való érintkezést. Ha a termék a szembe jut, akkor bő vízzel mossa ki.

 Kerülje a szemmel és bőrrel való érintkezést. Ha a termék a szembe jut, akkor bő vízzel mossa ki.

 Kerülje a szemmel és bőrrel való érintkezést. Ha a termék a szembe jut, akkor bő vízzel mossa ki.

 Kerülje a szemmel és bőrrel való érintkezést. Ha a termék a szembe jut, akkor bő vízzel mossa ki.

 Áram be / ki

 Áram be / ki

 Vizsgajel (lásd a oldalon 55)

 Vizsgajel (lásd a oldalon 55)

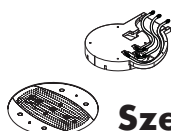

Szerelés Alapszett (lásd a oldalon 42)

Szerelés A kész szerelvény (lásd a oldalon 47)



Säkerhetsanvisningar

- ⚠ Handskar ska bäras under monteringsarbetet så att man kan undvika kläm- och skärskadorna werden.
- ⚠ Produkten får bara användas till kroppshygien med bad och dusch.
- ⚠ Barn samt vuxna med fysiska, psykiska eller sensoriska funktionshinder får inte använda produkten ensam. Personer som är påverkade av alkohol- eller droger får inte använda produkten.
- ⚠ Undvik att rikta duschstrålarna mot känsliga kroppsdelar (t. ex. ögonen). Det måste finnas ett tillräckligt stort avstånd mellan duschen och kroppen.
- ⚠ Stora tryckskillnader mellan anslutningarna för varmt och kallt vatten måste utjämnas.

⚡ Elektrisk anslutning

- ⚠ Elanslutningen får endast utföras av en elektroinstallatör!
- ⚠ Förinstallera nätspänning 100-240V/N/PE/50-60Hz (längd: 0,3 m).
- ⚠ Säkringen måste ske via en felströms-skyddsanordning (RCD/ FI) med en differensström på ≤ 30 mA.
- ⚠ Produkten ska anslutas till en på plats befintlig potentialutjämning (PA) 4 mm².

⚡ Elinstallatör

- ⚠ Installations- och kontrollarbeten ska utföras av behörig elektroinstallatör, enligt VDE 0100 del 701, IEC 60364-6 o. IEC 60364-7-701 samt EN 60335-2-105.
- ⚠ Nätkabeln ska införas dubbelt isolerad  i koppling dosan.

Monteringsanvisningar

- Det måste undersökas om produkten har transportskador innan den monteras. Efter monteringen accepteras inga transport- eller ytskiktsskador.
- Ledningarna och blandaren måste monteras, spolats igenom och kontrolleras enligt de gällande normerna.
- De installationsriktlinjer som gäller i länderna ska följas.
- När kvalificerad fackpersonal monterar produkten är det viktigt att fästytan är plan över hela fastsättningsområdet (inga fogar som sticker ut eller kakelförskjutning) och att väggstrukturen är lämplig för en montering av produkten och inte har några svaga punkter.

- Tänk på elledningar och vattenrör vid borrning!
- Tömningskapaciteten måste vara tillräcklig.
- Duschen får bara anslutas efter en spärrventil eller sanitärblandare.
- Produkten är inte avsedd att användas tillsammans med ett ångbad!

Tekniska data































Driftstryck framför blandaren: max. 1 MPa
 Rek. driftstryck: 0,3 - 0,5 MPa
 (1 MPa = 10 bar = 147 PSI)

Varmvattentemperatur: max. 60°C
 Rek. varmvattentemp.: 42°C
 Säkerhetsspärr: 40°C

Varning: om angiven temperatur överskrids kan detta leda till förbränningar!

Termisk desinfektion: max. 70°C / 4 min
 Nominell spänning: 100-240V AC 50-60Hz
 Nominell förbrukning: 18 W
 Lampa 4 x LED: 12V DC SELV 4 W
 Lampan kan inte dimmas.
 Skyddsklass: II
 Skyddstyp: IPX5

Symbolförklaring

	Använd inte silikon som innehåller ättiksyra!		Vattenanslutning DN20		Tomledning för stömförsörjning
	Måtten (se sidan 32)		Varmvatten		Vattenanslutning DN20
	Monteringsexempel (se sidan 34)		Kallvatten		Invändig ventil
	Hantering (se sidan 31)		Quattro Fyrvägsomkastare		Quattro Fyrvägsomkastare
	Reservdelar (se sidan 31)		Trio Universell avstängningsventil och omkastare		Trio Universell avstängningsventil och omkastare
	Service Byta glödlampa (se sidan 53)		HighFlow		Termostat HighFlow
	Rengöring (se sidan 50)		Avloppet måste klara mer än 50 l/min.		Avloppet måste klara mer än 50 l/min.
	Elinstallatör		Avlopp		Avlopp
	Skötsel (se sidan 54) Skyddsanordningens funktion måste kontrolleras med jämna mellanrum		Raindrain		Mittens av duschkaret
			X		Slå på vatten / Stäng av vattnet
					



Montering Grundset (se sidan 42)



Montering Färdigset (se sidan 47)



Saugumo technikos nurodymai

- ⚠️ Apsaugai nuo užspaudimo ir įsijovimo montavimo metu mūvėkite pirštines.
- ⚠️ Gaminy s turi būti naudojamas tik maudymuisi, kūno higienai ir švarai palaikyti.
- ⚠️ Gaminių draudžiama naudotis vaikams, taip pat suaugusiems su fizine, dvasine negale ir (arba) sensorikos sutrikimais. Gaminių taip pat draudžiama naudotis asmenims, apsvaigusiems nuo alkoholio arba narkotikų.
- ⚠️ Būtina vengti dušo vandens srovės kontakto su jautriomis kūno vietomis (pvz., akimis). Todėl būtina laikytis tinkamo atstumo nuo dušo.
- ⚠️ Turi būti išlyginti šalto ir karšto slėgio nelygumai.

⚠️ Elektros prijungimas

- ⚠️ Elektrą prijungti turi elektrikas!
- ⚠️ Iš anksto parenkite maitinimo šaltinį 100-240V/N/PE/50-60Hz (0,3 m ilgio).
- ⚠️ Apsauginis įrenginys (RCD / FI) apsaugo nuo nebalanso srovės, kai srovių skirtumas ≤ 30 mA.
- ⚠️ Gaminį reikia prijungti prie montavimo vietoje esančio potencialų išlyginimo įtaiso (PA) 4 mm².

⚠️ Elektromontuotojas

- ⚠️ Įrengimo ir tikrinimo darbus gali atlikti tik kvalifikuoti elektrikai pagal VDE 0100 701 d. ir IEC 60364-7-701, IEC 60364-6 bei 60335-2-105 standartų reikalavimus.
- ⚠️ Dvigubai izoliuotą prijungimo prie tinklo laidą  įveskite į jungiamąjį lizdą.

Montavimo instrukcija





























- Prieš montuojant būtina patikrinti, ar gaminys nebuvo pažeistas transportavimo metu. Sumontavus pretenzijos dėl transportavimo ir paviršiaus pažeidimų nepriimamos.
- Vamzdžiai ir sujungimai turi būti montuojami, plaunami ir tikrinami pagal galiojančias normas.
- Laikykites atitinkamoje šalyje galiojančių direktyvų dėl įrengimo.
- Atlikdami montavimo darbus, kvalifikuoti darbuotojai turi atkreipti dėmesį, kad pritvirtinimo plokštuma būtų lygi (be išsikišusių siūlių ar perkreiptų plytelių), sienų konstrukcija tiktų gaminiui montuoti ir neturėtų jokių trūkumų.

- Gręžiant atkreipkite dėmesį į esamas elektros ir vandens linijas
- Vandens nubėgimas privalo būti pakankamas.
- Dušo galvą galima prijungti tik už uždarymo vožtuvo arba sanitarinio maišytuvo.
- Gaminis netinkamas naudoti garo pirtyje!

Techniniai duomenys

Darbinis slėgis prieš maišytuvą:	ne daugiau kaip 1 MPa
Rekomenduojamas slėgis:	0,3 - 0,5 MPa (1 MPa = 10 barų = 147 PSI)
Karšto vandens temperatūra:	ne daugiau kaip 60 °C
Rekomenduojama karšto vandens temperatūra:	42 °C
Apsauginė blokuotė:	40 °C
Įspėjimas: dėl padidėjusios temperatūros kyla nudegimų grėsmė!	
Terminis dezinfekavimas:	ne daugiau kaip 70 °C / 4 min
Nominali įtampa	100-240V AC 50-60Hz
Nominalioji imamoji galia	18 W
Šviestuvai 4 x LED:	12V DC SELV 4 W
Žibinto šviesos ryškumas nereguliuojamas.	
Apsaugos klasė	II
Apsaugos tipas	IPX5

Simbolio aprašymas

	Nenaudokite silikono, kurio sudėtyje yra acto rūgšties!		Vandens prijungimas DN20		Tuščiaaviduris vamzdelis elektros aprūpinimui
	Išmatavimai (žr. psl. 32)		Šiltas vanduo		Karštas paviršius!
	Montavimo pavyzdžiai (žr. psl. 34)		Vandens prijungimas DN20		Mūvėkite apsaugines pirštines
	Eksploatacija (žr. psl. 31)		Šaltas vanduo		Dėvėkite akių apsaugines priemones
	Atsarginės dalys (žr. psl. 31)		Potinkinis uždarymo vožtuvas		Natūrali kempinė
	Priežiūros šviesos šaltinio pakeitimas (žr. psl. 53)		„Quattro“ 4-krypčių perjungimas		Nukalkintojas (citrinos rūgšties pagrindu)
	Valymas (žr. psl. 50)		Užvarinis ir perjungimo vožtuvas „Trio Universal“		Venkite, kad produkto nepatektų į akis ir ant odos. Patekus į akis, jas kruopščiai nuplaukite vandeniu.
	Elektromontuotojas		Termostatas HighFlow		Srovė įj./ išj.
	Techninis aptarnavimas (žr. psl. 54)		Nutekėjimo našumas turi būti ne mažesnis 50 l/min		Bandymo pažyma (žr. psl. 55)
	Turi būti reguliariai tikrinamas finakamas saugos įrangos veikimas.		Nutekėjimas		
			Dušo padėklo centras		
			Įjunkite vandens tiekimą / Išjungti vandens tiekimą		



Montavimas Pagrindinis komplektas (žr. psl. 42)



Montavimas Virštinkinė (žr. psl. 47)

**Sigurnosne upute**

- ⚠ Prilikom montaže se radi sprječavanja prignječenja i posjekotina moraju nositi rukavice.
- ⚠ Proizvod se smije primjenjivati samo za kupanje, tuširanje i osobnu higijenu.
- ⚠ Djeca, kao i tjelesno, mentalno i/ili senzorno hendikepirane odrasle osobe ne smiju se koristiti proizvodom bez nadzora. Osobe koje su pod utjecajem alkohola ili droga ne smiju se koristiti proizvodom.
- ⚠ Mora se izbjegavati kontakt mlaza iz tuša s osjetljivim dijelovima tijela (npr. očima). Tijelo korisnika mora biti dovoljno udaljeno od tuša.
- ⚠ Velika razlika u pritisku između vruće i hladne vode mora biti izbalansirana.

⚡ Električni priključak

- ⚠ Električnu smije priključiti samo ovlašteni električar!
- ⚠ Prethodno priključite naponsko napajanje 100-240V/N/PE/50-60Hz (duljina: 0,3 m).
- ⚠ Vod se mora osigurati nadstrujnom zaštitnom sklopkom (RCD/FI) s nazivnom diferencijalnom strujom ≤ 30 mA.
- ⚠ Proizvod se mora priključiti na postojeće izjednačenje potencijala (PA) 4 mm².

⚡ elektroinstalater

- ⚠ Električne instalacijske i ispitne radove smiju obavljati samo certificirani električari uz uvažavanje odredaba VDE 0100 dio 701, IEC 60364-6 i IEC 60364-7-701 te EN 60335-2-105.
- ⚠ Strujni priključni kabel mora se dvostruko izoliran  uvesti u priključnicu.

Upute za montažu

- Prije montaže mora se provjeriti je li proizvod oštećen prilikom transporta. Nakon ugradnje se ne priznaju nikakve reklamacije koje se odnose na površinska i transportna oštećenja.
- Cijevi i armatura moraju biti postavljeni, isprani i testirani prema važećim normama.
- Obvezno se moraju uvažiti propisi o instalacijama koji vrijede u dotičnoj zemlji.
- Kada proizvod montira kvalificirano stručno osoblje treba paziti da čitava površina na koju se učvršćuje bude ravna (bez istaknutih fuga ili krivljenja pločica), da je zidna konstrukcija primjerena montaži proizvoda te da nema slabih mjesta.

- Prilikom bušenja treba paziti na strujne vodove i vodovodne cijevi!
- Potreban je optimalan protok vode
- Tuš se smije priključivati samo iza zapornog ventila ili iza sanitarne armature.
- Proizvod nije predviđen za primjenu u parnim kupaonicama!

Tehnički podaci

Radni tlak ispred armature:
Preporučeni tlak:

tlak 1 MPa
0,3 - 0,5 MPa
(1 MPa = 10 bar = 147 PSI)

Temperatura vruće vode:
Preporučena temperatura vruće vode:
Sigurnosni zapor:

tlak 60 °C
42 °C
40 °C

Upozorenje: Prekoračenje ove temperature može izazvati opekline!

Termička dezinfekcija:

tlak 70 °C / 4 min

Nazivni napon

100-240V AC 50-60Hz

Nazivna potrošnja

18 W

Svjetiljke 4 x LED:

12V DC SELV 4 W

Svjetiljka se ne može prigušiti.

Stupanj zaštite

II

Stupanj zaštite

IPX5

Opis simbola

 Nemojte koristiti silikon koji sadrži octenu kiselinu!

 **Mjere** (pogledaj stranicu 32)

 **Primjeri instalacija**
(pogledaj stranicu 34)

 **Upotreba** (pogledaj stranicu 31)

 **Rezervni dijelovi**
(pogledaj stranicu 31)

 **Servisni Zamjena rasvjetnih tijela** (pogledaj stranicu 53)

 **Čišćenje** (pogledaj stranicu 50)

 **elektroinstalater**

 **Održavanje**
(pogledaj stranicu 54)

U redovitim vremenskim intervalima treba provjeravati ispravnost zaštitne sklopke.

 priključak na dovod vode DN20

 Topla voda

 priključak na dovod vode DN20

 Hladna voda

 Podžbukni ventil

 Quattro četverostruki preusmjernivač

Quattro

 Trio Universal ventil za zatvaranje i ventil selektora

Trio

 High Flow Termostat HighFlow

High Flow

 Protok vode mora biti veći od 50 l/min.

> 50 l/min

 Odvod

Raindrain

 Sredina tuš-kada

X

 Otvorite dotok vode / Zatvorite vodu

 šuplja cijev za električno napajanje

 Upozorenje na opasnost od vrela površine!

 Nosite zaštitne rukavice

 Nosite zaštitne naočale

 prirodna spužva

 **Sredstvo za uklanjanje kamenca** (na bazi limunske kiseline)
Izbjegavajte kontakt s očima i kožom. U slučaju kontakta s očima, temeljito isperite s dosta vode.

 Struja uklj. / isklj.

 **Oznaka testiranja**
(pogledaj stranicu 55)



Sastavljanje osnovna garnitura (pogledaj stranicu 42)



Sastavljanje Završni set (pogledaj stranicu 47)



Güvenlik uyarıları

- ⚠ Montaj esnasında ezilme ve kesilme gibi yaralanmaları önlemek için eldiven kullanılmalıdır.
- ⚠ Ürün yalnızca banyo, hijyen ve beden temizliği amaçları doğrultusunda kullanılabilir.
- ⚠ Bedensel, ruhsal ve/veya sensörük engelli çocuk ve yetişkinler gözetimsiz olarak duş sistemini kullanmamalıdır. Alkol veya uyuşturucu etkisinde olanlar duş sistemini kullanmamalıdır.
- ⚠ Püskürtme başlıklarının hassas organlara teması (örn. gözler) önlenmelidir. Püskürtücü ile beden arasında yeterli mesafe bırakılmalıdır.
- ⚠ Sıcak ve soğuk su bağlantıları arasında büyük basınç farklılıkları varsa, bu basınç farklılıklarının dengelenmesi gerekir.

⚡ Elektrik bağlantısı

- ⚠ Elektrik bağlantısı sadece bir elektrik teknisyeni tarafından yapılmalıdır!
- ⚠ Gerilim beslemesini 100-240V/N/PE/50-60Hz (uzunluk: 0,3 m) önceden kurun.
- ⚠ Emniyete alma, ≤ 30 mA ölçüm farkı akımı olan bir hatalı akım koruma tertibatı (RCD/FI) üzerinden gerçekleştirilmelidir.
- ⚠ Ürün, yapı tarafı mevcut bir potansiyel dengelemesine (PA) 4 mm² bağlanmalıdır.

⚡ Elektronik montajcısı

- ⚠ Kurulum ve kontrol çalışmaları, VDE 0100 Bölüm 701, IEC 60364-6 ve IEC 60364-7-701'i ve EN 60335-2-105'i dikkate almak suretiyle, elektronik konusunda uzman yetkili bir kişi tarafından gerçekleştirilmelidir.
- ⚠ Şebeke bağlantı hattı çift izole  biçimde bağlantı utusuna yerleştirilmelidir.

Montaj açıklamaları

- Montaj işleminden önce ürün nakliye hasarları yönünden kontrol edilmelidir. Montaj işleminden sonra nakliye veya yüzey hasarları için sorumluluk üstlenilmemektedir.
- Boruların ve armatürün montajı, yıkanması ve kontrolü geçerli normlara göre yapılmalıdır.
- Ülkelerde geçerli kurulum yönetmeliklerine riayet edilmelidir.

- Ürünün yetkili uzman personel tarafından montajı yapılırken, sabitleme yüzeyinin sabitleme planının tüm alanında bulunduğu (derz veya fayans kayması olmamalıdır), duvar yapısının ürünün montajı için uygun olduğuna ve zayıf noktaları bulunmadığına dikkat edilmelidir.
- Delik açarken elektrik ve su hatlarına dikkat!
- Çıkış kapasitesi yeterli miktarda boyutlandırılmış olmalıdır.
- Su püskürtücü yalnızca sıhhi armatür veya kapatma vanasından sonra bağlanabilir.
- Ürün bir buhar banyosu ile bağlantılı olarak kullanım için öngörülmemiştir!

Teknik bilgiler

Bataryadan önceki işletme basıncı
Tavsiye edilen işletme basıncı:

azami 1 MPa
0,3 - 0,5 MPa
(1 MPa = 10 bar = 147 PSI)

Sıcak su sıcaklığı:

azami 60 °C

Tavsiye edilen su ısısı:

42 °C

Güvenlik blokağı:

40 °C

Uyarı: Bu sıcaklığın aşılması, yangınlara neden olabilir!

Termik dezenfeksiyon:

azami 70 °C / 4 dak

Nominal gerilim

100-240V AC 50-60Hz

Nominal giriş

18 W

Lambalar 4 x LED:

12V DC SELV 4 W

Aydınlatma maddesi kısılamaz.































Koruma sınıfı

II

Koruma türü

IPX5

Simge açıklaması

	Asetik asit içeren silikon kullanmayın!		Su bağlantısı DN20		Akım beslemesi için boş boru
	Ölçüleri (bakınız sayfa 32)		Sıcak su		Sıcak yüzeye karşı uyarı!
	Montaj Örneği (bakınız sayfa 34)		Su bağlantısı DN20		Koruyucu eldiven kullanın
	Kullanımı (bakınız sayfa 31)		Soğuk su		Göz koruyucu kullanın
	Yedek Parçalar (bakınız sayfa 31)		Sıva altı valfi		Doğal Sünger
	Servis Ampul değiştirme (bakınız sayfa 53)		Quattro dört yollu değiştirme		Kireç sökücü (Limon asidi temeli) Gözlere ve cilde temasından kaçının. Eğer ürün gözlere bulaşırsa, gözlerinizi su ile iyice yıkayın.
	Temizleme (bakınız sayfa 50)		Trio üniversal kapatma ve değiştirme valfi		
	Elektronik montajcısı		HighFlow		
	Bakım (bakınız sayfa 54) Koruyucu donanım düzenli aralıklarla işlev bakımından kontrol edilmelidir.		Akış kapasitesi 50 l/dak üzerinde olmalıdır.		
			Akış		Akım açık / kapalı
			Raindrain		Kontrol işareti (bakınız sayfa 55)
			Duş küvetinin ortası		
			Suyu açın / Suyu kesin		



Montajı Ana set (bakınız sayfa 42)



Montajı Dışı set (bakınız sayfa 47)



Instrucțiuni de siguranță

- ⚠ La montare utilizați mănuși pentru evitarea contuziunilor și tăierii mâinilor.
- ⚠ Produsul poate fi utilizat doar pentru spălarea, menținerea igienei și curățarea corpului.
- ⚠ Copiii și adulții cu dizabilități corporale, mintale și senzoriale nu pot utiliza sistemul de duș nesupravegheați. De asemenea este interzisă utilizarea sistemului de duș de către persoane, care se află sub influența alcoolului sau a drogurilor.
- ⚠ Evitați contactul jetului de apă cu părțile de corp sensibile (de ex. ochii). Țineți dușul la o distanță corespunzătoare de corp.
- ⚠ Diferențele de presiune mari între alimentarea cu apă rece și apă caldă trebuie echilibrate.

⚡ Conexiune electrică

- ⚠ Racordarea la rețeaua electrică poate fi efectuată numai de către un tehnician electronist specializat!
- ⚠ Preinstalați 100-240V/N/PE/50-60Hz (lungime: 0,3 m) cablul de alimentare cu curent.
- ⚠ Instalația trebuie asigurată printr-un dispozitiv de protecție împotriva curentului rezidual (RCD/ FI) pentru curent rezidual măsurat de ≤ 30 mA.
- ⚠ Produsul trebuie conectat la un egalizator de potențial la fața locului (PA) 4 mm².

⚡ Electrician

- ⚠ Lucrările de instalare și de verificare trebuie efectuate de către electricieni specializați, ținând cont de VDE 0100 Partea 701, IEC 60364-6 și IEC 60364-7-701, cât și EN 60335-2-105.
- ⚠ Cablul de alimentare de la rețea trebuie introdus dublu izolat  în cutia de conexiuni.

Instrucțiuni de montare



- Înainte de instalare verificați, dacă produsul prezintă deteriorări de transport. După instalare garanția nu acoperă deteriorările de transport și cele de suprafață.
- Conductele și bateriile trebuie montate, spălate și verificate conform normelor în vigoare.

- Respectați reglementările referitoare la instalare valabile în țara respectivă.
- La montarea produsului de către un personal calificat se va avea grijă ca suprafața de fixare să fie plană pe toată aria de fixare (fără proeminențe ale rosturilor sau îmbinări între plăcile de faianță) și ca structura peretelui să fie corespunzătoare pentru fixarea produsului, să nu prezinte locuri cu rezistență redusă.
- La efectuarea lucrărilor de găurire fiți atenți la conductele de apă și cablurile electrice!
- Debitul de golire trebuie să fie suficient de mare.
- Dușul poate fi instalat doar după un ventil de închidere sau o armătură sanitară.
- Produsul nu este prevăzut pentru a fi folosit în combinație cu o baie de aburi!

Date tehnice

Presiune de funcționare înainte de baterie:	max. 1 MPa
Presiune de funcționare recomandată:	0,3 - 0,5 MPa (1 MPa = 10 bar = 147 PSI)
Temperatura apei calde:	max. 60 °C
Temperatura recomandată a apei calde:	42 °C
Blocaj de siguranță:	40 °C
Atenție: depășirea acestei temperaturi poate cauza arsuri!	
Dezinfecție termică:	max. 70 °C / 4 min
Tensiune nominală	100-240V AC 50-60Hz
Putere nominală	18 W
Lămpi 4 x LED:	12V DC SELV 4 W
Intensitatea luminii nu este reglabilă.	
Clasă de protecție	II
Clasă de protecție	IPX5

Descrierea simbolurilor

	Nu utilizați silicon cu conținut de acid acetic!		Racord de apă DN20		Tub pentru conductele de alimentare electrică
	Dimensiuni (vezi pag. 32)		Apă caldă		Atenție la suprafața fierbinte!
	Exemple de montare (vezi pag. 34)		Racord de apă DN20		Purtați mănuși de protecție
	Utilizare (vezi pag. 31)		Apă rece		Purtați ochelari de protecție
	Piese de schimb (vezi pag. 31)		Ventil montat sub tencuială		Burete natural
	service Înlocuirea luminii (vezi pag. 53)		Quattro valvă de inversare cu patru căi		Soluție de decalcifiere (bază de acid citric)
	Curățare (vezi pag. 50)		Trio valvă de închidere și de inversare universală		Evitați contactul cu ochii și cu pielea. În cazul în care produsul ajunge în contact cu ochii, clătiți bine cu apă.
	Electrician		Termostat HighFlow		Curent pornit / oprit
	Întreținere (vezi pag. 54)		Capacitatea de evacuare trebuie să fie mai mare de 50 l/min.		Certificat de testare (vezi pag. 55)
	Dispozitivul de protecție trebuie verificat la intervale regulate.		Deversor		
			În mijlocul căzii de duș		
			Se introduce apa / Opriți alimentarea cu apă		



Montare Set de bază (vezi pag. 42)



Montare Set complet (vezi pag. 47)



Υποδειξεις ασφαλείας

- ⚠ Για να αποφύγετε τραυματισμούς κατά τη συναρμολόγηση πρέπει να φοράτε γάντια.
- ⚠ Το προϊόν επιτρέπεται να χρησιμοποιείται μόνο σαν μέσο λουτρού, υγιεινής και καθαρισμού του σώματος.
- ⚠ Παιδιά ή ενήλικες με μειωμένες σωματικές, διανοητικές και/ή αισθητήριες ανεπάρκειες δεν επιτρέπεται να χρησιμοποιούν το προϊόν χωρίς επιτήρηση. Άτομα υπό την επήρεια οινοπνεύματος ή ναρκωτικών δεν επιτρέπεται να χρησιμοποιούν σε καμία περίπτωση το προϊόν.
- ⚠ Η επαφή δέσμης νερού του ντους με ευαίσθητες περιοχές του σώματος (π.χ. μάτια) πρέπει να αποφεύγεται. Διατηρείτε επαρκή απόσταση ανάμεσα στο ντους και το σώμα.
- ⚠ Οι διαφορές της πίεσης μεταξύ της σύνδεσης κρύου και ζεστού νερού θα πρέπει να αντισταθμίζονται.

Ηλεκτρική παροχή

- ⚠ Η ηλεκτρική εγκατάσταση επιτρέπεται να πραγματοποιηθεί μόνο από εξειδικευμένο ηλεκτρολόγο!
- ⚠ Παροχή ρεύματος 100-240V/N/PE/50-60Hz (Μήκος: 0,3 μέτρα) προεγκατάσταση.
- ⚠ Η ασφάλιση θα πρέπει να πραγματοποιείται μέσω διάταξης προστασίας ρεύματος διαρροής (RCD/ FI) με παραμένον ρεύμα ≤ 30 mA.
- ⚠ Το προϊόν πρέπει να συνδεθεί με μία ισοδυναμική σύνδεση (PA) 4 mm² που έχει προεγκατασταθεί από τον πελάτη.

Ηλεκτρολόγος εγκατάστασης

- ⚠ Οι εργασίες εγκατάστασης και ελέγχου πρέπει να διενεργούνται από έναν εγκεκριμένο ειδικό ηλεκτρολόγο, λαμβάνοντας υπόψη τις οδηγίες VDE 0100 Μέρος 701, IEC 60364-6 και IEC 60364-7-701 καθώς και το EN 60335-2-105.
- ⚠ Το καλώδιο σύνδεσης πρέπει να εισαχθεί με διπλή μόνωση στο κουτί σύνδεσης.

Οδηγίες συναρμολόγησης

- Πριν τη συναρμολόγηση πρέπει να εξεταστεί το προϊόν για ζημιές μεταφοράς. Μετά την εγκατάσταση δεν αναγνωρίζονται ζημιές από τη μεταφορά ή επιφάνεια-

κές ζημιές.

- Οι σωλήνες και η μπαταρία πρέπει να τοποθετηθούν σύμφωνα με τα ισχύοντα πρότυπα, να τεθούν υπό πίεση και να δοκιμαστούν.
- Θα πρέπει να τηρούνται οι οδηγίες εγκατάστασης που ισχύουν σε κάθε κράτος.
- Κατά τη συναρμολόγηση του προϊόντος από ειδικό προσωπικό θα πρέπει να ελέγχεται με ιδιαίτερη προσοχή η επιφάνεια στερέωσης, αν είναι επίπεδη σε όλη της την επιφάνεια (δεν πρέπει να εξέχουν αρμοί ή πλακάκια), αν η υποδομή του τοίχου είναι κατάλληλη για τη στερέωση του προϊόντος και αν παρουσιάζει ασθενή σημεία.
- Προσοχή όταν τρυπάτε πάνω από σωλήνες ηλεκτρικού ή νερού!
- Η κατανάλωση νερού πρέπει να έχει επαρκείς διαστάσεις.
- Το ντους επιτρέπεται να συνδέεται μόνο αφού προηγηθεί στο κύκλωμα μία βαλβίδα διακοπής ή μπαταρία.
- Το προϊόν δεν είναι κατάλληλο για χρήση σε ατμόλουτρο!

Τεχνικά Χαρακτηριστικά

Πίεση λειτουργίας προ της βάνας:
Συνιστώμενη λειτουργία πίεσης:

έως 1 MPa
0,3 - 0,5 MPa
(1 MPa = 10 bar = 147 PSI)

Θερμοκρασία ζεστού νερού:
Συνιστώμενη θερμοκρασία ζεστού νερού:
Ασφάλεια υπερθέρμανσης νερού

έως 60 °C
42 °C
40 °C

Προειδοποίηση: Υπέρβαση αυτής της θερμοκρασίας μπορεί να προκαλέσει εγκαύματα

Θερμική απολύμανση:
Ονομαστική τάση
Ονομαστική ισχύς
Φωτιστικά 4 x LED:
Το φωτιστικό δεν διαθέτει ροοστάτη.
Κατηγορία προστασίας
Είδος προστασίας

έως 70 °C / 4 min
100-240V AC 50-60Hz
18 W
12V DC SELV 4 W

II
IPX5

Περιγραφή συμβόλων

- Μην χρησιμοποιείτε σιλικόνη που περιέχει οξικό οξύ!
- Διαστάσεις** (βλ. Σελίδα 32)
- Παραδείγματα συναρμολόγησης** (βλ. Σελίδα 34)
- Χειρισμός** (βλ. Σελίδα 31)
- Ανταλλακτικά** (βλ. Σελίδα 31)
- Οέρβις Αντικατάσταση φωτιστικού** (βλ. Σελίδα 53)
- Καθαρισμός** (βλ. Σελίδα 50)
- Ηλεκτρολόγος εγκατάστασης**
- Συντήρηση** (βλ. Σελίδα 54)
Η λειτουργία της διάταξης προστασίας πρέπει να ελέγχεται σε τακτά χρονικά διαστήματα.

- Παροχή νερού DN20
- Ζεστό νερό
- Παροχή νερού DN20
- Κρύο νερό
- Χωνευτή βαλβίδα
- Quattro
- Quattro τετράοδης μετατροπής
- Trio Universal βαλβίδα κλεισίματος και εκτροπής
- Trio
- HighFlow
- Θερμοστάτης HighFlow
- Η αποχετευτική ικανότητα της βαλβίδας εκροής πρέπει να υπερβαίνει τα 1/min.
- > 50 l/min
- Βαλβίδα εκροής
- Rain drain
- Μέσον της ντουσιέρας
- X
- Ανοίξτε την παροχή του νερού / Κλείστε την παροχή νερού

- Κενός σωλήνας για την παροχή ρεύματος
- Προειδοποίηση: καυτή επιφάνεια!
- Φοράτε γάντια προστασίας χεριών
- Φοράτε γυαλιά προστασίας ματιών
- Φυσικός σπόγγος**
- Αποσκληρυντής νερού** (με βάση το κιτρικό οξύ)
Αποφεύγετε την επαφή με τα μάτια και το δέρμα. Σε περίπτωση που έλθει το προϊόν σε επαφή με τα μάτια ξεπλύνετε καλά με νερό.
- Ρεύμα on / off
- Σήμα ελέγχου** (βλ. Σελίδα 55)



Συναρμολόγηση Βασικό σετ (βλ. Σελίδα 42)



Συναρμολόγηση Σετ μηχανισμού (βλ. Σελίδα 47)



Varnostna opozorila

- ⚠ Pri montaži je treba nositi rokavice, da se preprečijo poškodbe zaradi zmečkavanja ali urezov.
- ⚠ Ta izdelek se sme uporabljati le z namenom umivanja, vzdrževanja higiene in telesne nege.
- ⚠ Otroci kot tudi odrasle osebe z omejenimi telesnimi, duševnimi in/ali senzoričnimi sposobnostmi ne smejo nenadzorovano uporabljati tega izdelka. Osebe, ki so pod vplivom alkohola ali drog, tega izdelka ne smejo uporabljati.
- ⚠ Izogibati se je treba stiku prhalnega curka z občutljivimi deli telesa (npr. očmi). Med telesom in prho mora biti vedno zadosten razmik.
- ⚠ Velike razlike v tlaku med priključkom za mrzlo in priključkom za toplo vodo je potrebno izravnati.

⚡ Električni priključek

- ⚠ Električno priključitev sme izvesti le elektrostrokovnjak!
- ⚠ Napajanje 100-240V/N/PE/50-60Hz (dolžina: 0,3 m) predhodno instalirajte.
- ⚠ Zaščita se mora izvesti preko zaščitnega tokovnega stikala (RCD/ FI) z izračunanim diferenčnim tokom ≤ 30 mA.
- ⚠ Izdelek mora biti priključen na potencialno izravnavo (PA) 4 mm² na lokaciji.

⚡ Elektroinštalater

- ⚠ Instalacijo in preizkuse mora izvesti pooblaščen elektro strokovnjak, pri čemer mora upoštevati VDE 0100 Del 701, IEC 60364-6 in IEC 60364-7-701 ter EN 60335-2-105.
- ⚠ Omrežni priključni kabel je treba dvojno izoliran  vstaviti v priključno dozo.

Navodila za montažo

- Pred montažo je treba izdelek preveriti glede morebitnih transportnih poškodb. Po vgradnji transportne ali površinske poškodbe ne bodo več priznane.
- Cevi in armaturo je treba montirati, izprati in preveriti po veljavnih standardih.
- Upoštevati je treba pravilnike o inštalacijah, ki veljajo v posamezni državi.
- Pri montaži tega proizvoda s strani kvalificiranega strokovnega osebja je treba paziti na to, da je pritrdilna ploskev na celotni površini za pritrditev gladka (brez izstopajočih fug ali zasekov ploščic), da je struktura stene primerna za montažo



































proizvoda in ne kaže šibkih mest.

- Pri vrtnanju bodite pozorni na električne vodnike in vodovodno napeljavo
- Zmogljivost odtoka mora biti ustrezne velikosti.
- Prha se sme priključiti le za zapornim ventilom ali sanitarno armaturo.
- Proizvod ni predviden za uporabo v povezavi s parno kopaljo!

Tehnični podatki

Obratovalni tlak pred armaturo:	maks. 1 MPa
Priporočeni delovni tlak:	0,3 - 0,5 MPa (1 MPa = 10 bar = 147 PSI)
Temperatura tople vode:	maks. 60 °C
Priporočena temperatura tople vode:	42 °C
Varnostna blokada:	40 °C
Opozorilo: prekoračitev te temperature lahko povzroči opekline!	
Termična dezinfekcija:	maks. 70 °C / 4 min
Nazivna napetost	100-240V AC 50-60Hz
Nazivna poraba	18 W
Svetilke 4 x LED:	12V DC SELV 4 W
Svetilka nima možnosti uravnavanja zatemnitve.	
Razred zaščite	II
Vrsta zaščite	IPX5

Opis simbola

	Ne smete uporabiti silikona, ki vsebuje osetno kislino!		Vodni priključek DN20		Prazna cev za napajanje
	Mere (glejte stran 32)		Topla voda		Opozorilo pred vročo površino!
	Primeri montaže (glejte stran 34)		Vodni priključek DN20		Nosite zaščitne rokavice
	Upravljanje (glejte stran 31)		Mrzla voda		Nosite zaščito za oči
	Rezervni deli (glejte stran 31)		Podometni ventil		Naravna gobica
	Servisni Zamenjava svetilke (glejte stran 53)		Quattro		Odstranjevalec apnenca (na osnovi citronske kisline) Izogibajte se stiku z očmi in kožo. Če proizvod pride v oči, jih temeljito sperite z vodo.
	Čiščenje (glejte stran 50)		Trio		
	Elektroinštalater		Trio Universal zaporni in preklopni ventil		
	Vzdrževanje (glejte stran 54) Delovanje zaščitne priprave je treba preverjati v rednih časovnih presledkih.		Trio HighFlow		Odtočna kapaciteta mora znašati več kot 50 l/min.
			> 50 l/min		Odtok
			Raindrain		Sredina pršne kadi
			X		Odprite vodo / Zaprite vodo.
					
					Tok vklop / izklop
					Preskusni znak (glejte stran 55)

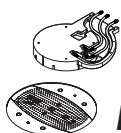

Montaža Osnovni komplet (glejte stran 42)

Montaža Zaključna garnitura (glejte stran 47)

**Ohutusjuhised**

- △ Kandke paigaldamisel muljumis- ja löikevigastuste vältimiseks kindaid.
- △ Toodet tohib kasutada ainult pesemis-, hügieeni- ja kehapihustamisesmärkidel.
- △ Lapsed, samuti kehaliste, vaimsete või tajupiirangutega täiskasvanud ei tohi dušisüsteemi järelevalveta kasutada. Alkoholi või narkootikumide mõju all olevad isikud ei tohi dušisüsteemi kasutada.
- △ Duši veejoad ei tohi kokku puutuda tundlike kehaosadega (nt silmad). Jätke duši ja keha vahele piisav vahe.
- △ Kui külma ja kuumu vee ühenduste surve on väga erinev, tuleb need tasakaalustada.

Elektriühendus

- △ Elektriühenduse peab läbi viima väljaõppinud elektrik!
- △ Eelpaigaldage pingega varustamine 100-240V/N/PE/50-60Hz (pikkus: 0,3 m).
- △ Kaitse peab toimuma rikkevoolu kaitseseadisega (RCD/FI) nominaaljätkuvooluga ≤ 30 mA.
- △ Toode tuleb ühendada kohapeal olemasoleva potentsiaaliühtlustusega (PA) 4 mm².

Elektrimontöör

- △ Paigaldustööd ja kontroll laske viia läbi sertifitseeritud spetsialistil vastavalt VDE 0100 osa 701, IEC 60364-6 ja IEC 60364-7-701 ning EN 60335-2-105 eeskirjadele.
- △ Võrgujuhe tuleb juhtida topeltisolatsiooniga  ühen use pistikupessa.

Paigaldamisjuhised

- Enne paigaldamist tuleb toodet kontrollida transpordikahjustuste osas. Pärast paigaldamist ei tunnustata enam transpordi- või pinnakahjustuste kaebuseid.
- Voolikute ja segisti paigaldamisel, loputamisel ja kontrollimisel tuleb lähtuda kehtivatest normatiividest.
- Vastavas riigis kehtivaid paigalduseeskirju tuleb järgida.
- Toote paigaldamisel kvalifitseeritud spetsialistide poolt tuleb jälgida, et kinnituspind oleks kogu ulatuses ühtlaselt tasane (mitte ühki üleseisvat vuuki või kaldus kahhelkivi), seina ülesehitus toote paigaldamiseks sobiv ja ilma nõrkade

kohtadeta.

- Arvestage puurimisel voolukaablite ja veejuhtmete asukohaga
- Äravoolu jõudlus peab olema piisav.
- Duši tohib ühendada ainult sulgurkraani või sanitaaramatuuri järele.
- Toode ei sobi kasutamiseks aurusaunas!

Tehnilised andmed

töörõhk süsteemis enne duši:
Soovitatav töörõhk:

maks. 1 MPa
0,3 - 0,5 MPa
(1 MPa = 10 baari = 147 PSI)

Kuumu vee temperatuur:
Soovitatav kuumu vee temperatuur:
Kaitselekk:

maks. 60 °C
42 °C
40 °C

Hoiatus: selle temperatuuri ületamisel võivad tekkida põletused!

Termiline desinfektsioon:

maks. 70 °C / 4 min

Nimipinge

100-240V AC 50-60Hz

Nimisisend

18 W

Valgustid 4 x LED:

12V DC SELV 4 W

Valgustit ei saa hämardada.

Kaitseklass

II

Kaitseklass

IPX5

Sümbolite kirjeldus

 Ärge kasutage äädikhapet sisaldavat silikooni!

 **Mõõtude** (vt lk 32)

 **Paigalduse näited** (vt lk 34)

 **Kasutamine** (vt lk 31)

 **Varuosad** (vt lk 31)

 **Varuos Lambi vahetamine**
(vt lk 53)

 **Puhastamine** (vt lk 50)

 **Elektrimontöör**

 **Hooldus** (vt lk 54)
Kaitseseadist tuleb regulaarselt kontrollida.

 Veeühendus DN20

 Soe vesi

 Veeühendus DN20

 Külma vesi

 peiteklapp

 Quattro-liitmik

 Quattro

 Katkestus- ja ümberlülitusklapp Trio Universal

 Trio

 HighFlow

 Termostaat HighFlow

 Äravoolu jõudlus peab olema suurem kui 50 l/min.

 > 50 l/min

 Äravool

 Raindrain

 Dušivanni kese

 Keerake vesi lahti / Keerake vesi kinni

 Keerake vesi lahti / Keerake vesi kinni

 elektrivarustus juhtmestiku paigaldus

 Kuum pealispind!

 Kandke kaitsekindaid

 Kandke kaitseprille

 Looduslik svamm

 **Katlakivi eemaldaja** (põhineb sidrunhappel)

 Vältige kokkupuudet silmade ja nahaga. Kui toode satub silma, siis loputage silmi hoolikalt veega..

 Elektrivool sees / väljas

 Elektrivool sees / väljas

 **Kontrollsertifikaat** (vt lk 55)

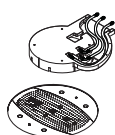
**Paigaldamine põhikomplekt** (vt lk 42)**Paigaldamine Valmiskomplekt** (vt lk 47)



Drošības norādes

- ⚠ Montāžas laikā, lai izvairītos no saspiedumiem un iegriezumiem, nepieciešams nēsāt cimdus.
- ⚠ Šo produktu drīkst izmantot tikai, lai mazgātos, higiēnai un ķermeņa tīrīšanai.
- ⚠ Bērni, kā arī pieaugušie ar fiziskiem, garīgiem un / vai sensoriskiem ierobežojumiem nedrīkst lietot šo produktu bez uzraudzības. Personas, kas atrodas alkohola vai narkotisko vielu iespaidā, nedrīkst lietot šo dušas sistēmu.
- ⚠ Nepieciešams izvairīties no dušas strūkļas tieša kontakta ar jutīgām ķermeņa daļām (piem., acīm). Nepieciešams ievērot pietiekošu attālumu starp dušu un ķermeni.
- ⚠ Jāizlīdzina spiediena atšķirības starp aukstā un karstā ūdens pievadiem.

⚡ Elektroapgādes pieslēgvietā

- ⚠ Elektrisko pieslēgumu drīkst veikt tikai elektriķis!
- ⚠ Barošanas bloku 100-240V/N/PE/50-60Hz (garums: 0,3 m) instalēt iepriekš.
- ⚠ Jānodrošina noplūdes strāvas aizsargsistēma (RCD/ FI) ar izmērīto strāvas starpību ≤ 30 mA.
- ⚠ Izstrādājums jāpieslēdz pasūtītāja paredzētajam potenciālu izlīdzinātājam (PA) 4 mm².

⚡ Elektromontieris

- ⚠ Instalācijas un pārbaudes darbus jāveic sertificētam speciālistam saskaņā ar DIN VDE 0100 701. d., IEC 60364-6, IEC 60364-7-701 un EN 60335-2-105.
- ⚠ Tīkla pieslēgšanas vads jāievada pieslēgšanas rozetē r dubultu izolāciju .

Norādījumi montāžai

- Pirms montāžas nepieciešams pārbaudīt, vai produktam transportēšanas laikā nav radušies bojājumi. Pēc iebūvēšanas bojājumi, kas radušies transportēšanas laikā, vai virsmas bojājumi netiek atzīti.
- Cauruļvadi un armatūra ir jāuzstāda, jāizskalo un jāpārbauda saskaņā ar spēkā esošajiem standartiem.
- Jāievēro attiecīgās valsts spēkā esošās montāžas prasības.
- Kvalificētiem speciālistiem, montējot produktu, jāpiegriež vērība tam, lai piestiprināšanas virsma visā piestiprināšanas zonā ir gluda (nav fūgu vai flīžu iecirtumu),

sienas uzbūve ir piemērota produkta montāžai un tajā nav nestabilu vietu.

- Urbjot pievērsiet uzmanību elektrības un ūdens vadiem!
- Noplūdei jānodrošina pietiekama ūdens caurplūde.
- Dušu drīkst pieslēgt tikai aiz noslēgšanas vārsta vai sanitāras armatūras.
- Produkts nav paredzēts lietošanai kopā ar tvaika vannu!

Tehniskie dati

Darba spiediens pirms jaucējkrāna:	maks. 1 MPa
Ieteicamais darba spiediens:	0,3 - 0,5 MPa (1 MPa = 10 bar = 147 PSI)
Karstā ūdens temperatūra:	maks. 60 °C
Ieteicamā karstā ūdens temperatūra:	42 °C
droša temperatūra	40 °C
Brīdinājums: šīs temperatūras pārsniegšana var izraisīt applaucēšanos!	
Termiskā dezinfekcija :	maks. 70 °C / 4 min
Nominālais spriegums	100-240V AC 50-60Hz
nominālais patēriņš	18 W
Gaismeļķi 4 x LED:	12V DC SELV 4 W
Lampas spilgtums nav regulējams.	
Aizsardzības klase	II
Aizsardzības līmenis	IPX5

Simbolu nozīme

Neizmantot silikonu, kas satur etiķskābi!	Ūdensvada pieslēgvietā DN20	Caurule strāvas padevei
Izmērus (skat. lpp. 32)	Siltais ūdens	Brīdinājums par karstu virsmu!
Montāžas piemēri (skat. lpp. 34)	Ūdensvada pieslēgvietā DN20	Valkāt aizsargcimdus
Lietošana (skat. lpp. 31)	Aukstais ūdens	Valkāt acu aizsargus
Rezerves daļas (skat. lpp. 31)	Zemapmetuma ventilis	Dabīgais sūklis
Apkopes Apgaismes ķermeņa nomainīšana (skat. lpp. 53)	Četrvirzienu pārslēgs	Atkalķotājs (uz citronskābes bāzes)
Tīrīšana (skat. lpp. 50)	Trišvirzienu universālais noslēgvārsts un pārslēdzējvārsts	Novērst nokļūšanu acīs un uz ādas. Ja produkts iekļūst acīs, tās kārtīgi jāskalo ar ūdeni.
Elektromontieris	High Flow	Strāva ieslēgta / izslēgta
Apkope (skat. lpp. 54)	Noteces veiktspējai jābūt vairāk nekā 50 l/min.	Pārbaudes zīme (skat. lpp. 55)
Ik pēc noteikta atstatuma jāpārbauda drošības ierīces funkcijas.	Notece	
	Raindrain	
	Dušas paliktna vidus	
	X	
	Atgrieziet ūdeni / Noslēgt ūdeni	



Montāža Pamatkomplekts (skat. lpp. 42)

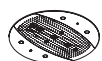

Montāža Komplekts (skat. lpp. 47)



Sigurnosne napomene

- ⚠ Prilikom montaže se radi sprečavanja prignječenja i posekotina moraju nositi rukavice.
- ⚠ Proizvod sme da se koristi samo za kupanje, tuširanje i ličnu higijenu.
- ⚠ Deca, kao i telesno, mentalno i/ili senzorno hendikepirane odrasle osobe ne smeju da koriste proizvod bez nadzora. Osobe koje su pod uticajem alkohola ili droga ne smeju da koriste proizvod.
- ⚠ Mora se izbegavati kontakt mlaza iz tuša sa osetljivim delovima tela (npr. očima). Telo korisnika mora biti na dovoljnom odstojanju od tuša.
- ⚠ Velika razlika u pritisku između vruće i hladne vode mora biti izbalansirana.

⚡ Električni priključak

- ⚠ Električnu sme priključiti samo ovlašćeni električar!
- ⚠ Prethodno priključite naponsko napajanje 100-240V/N/PE/50-60Hz (dužina: 0,3 m).
- ⚠ Vod se mora osigurati nadstrujnom zaštitnom sklopkom (RCD/FI) s nazivnom diferencijalnom strujom ≤ 30 mA.
- ⚠ Proizvod mora da se priključi na postojeće izjednačenje potencijala (PA) 4 mm².

⚡ elektroinstalater

- ⚠ Instalaciju i ispitivanje smeju obavljati isključivo sertifikovani električari uz uvažavanje odredaba VDE 0100 deo 701, IEC 60364-6 i IEC 60364-7-701 kao i EN 60335-2-105.
- ⚠ Strujni priključni kabl mora da se dvostruko izoliran  uvede u utičnicu.

Instrukcije za montažu

- Pre montaže se mora proveriti da li je proizvod oštećen pri transportu. Nakon ugradnje se ne priznaju nikakve reklamacije koje se odnose na površinska i transportna oštećenja.
- Vodovi i armatura moraju biti postavljeni, isprani i testirani prema važećim normama.
- Treba se pridržavati propisa koji u određenim zemljama važe za instalacije.
- Kada proizvod montira kvalifikovano stručno osoblje treba paziti da čitava površina na koju se učvršćuje bude ravna (bez istaknutih fuga ili krivljenja

pločica), da je zidna konstrukcija primerena montaži proizvoda i da nema slabih mesta.

- Prilikom bušenja treba paziti na električne kablove i vodovodne cevi!
- Mora se predvideti dovoljan kapacitet odvoda.
- Tuš se sme priključivati samo iza ventila za zatvaranje ili iza sanitarne armature.
- Proizvod nije predviđen za upotrebu u parnim kupatilima!































Tehnički podaci

Radni pritisak ispred armature:	maks. 1 MPa
Preporučeni radni pritisak:	0,3 - 0,5 MPa (1 MPa = 10 bar = 147 PSI)
Temperatura vruće vode:	maks. 60 °C
Preporučena temperatura vruće vode:	42 °C
Sigurnosni prekid:	40 °C

Upozorenje: Prekoračenje ove temperature može da izazove opekotine!

Termička dezinfekcija:	maks. 70 °C / 4 min
Nominalni napon:	100-240V AC 50-60Hz
Nominalna potrošnja:	18 W
Svetiljke 4 x LED:	12V DC SELV 4 W
Sijalica nije prigušiva.	
Klasa zaštite:	II
Klasa zaštite:	IPX5

Opis simbola

	Nemojte koristiti silikon koji sadrži sirćetnu kiselinu!		priključak za vodu DN20		Šuplja cev za električno napajanje
	Mere (vidi stranu 32)		Topla voda		Upozorenje na opasnost od vrelе površine!
	Primeri montaže (vidi stranu 34)		priključak za vodu DN20		Nosite zaštitne rukavice
	Rukovanje (vidi stranu 31)		Hladna voda		Nosite zaštitne naočare
	Rezervni delovi (vidi stranu 31)		Uzidni ventil		prirodni sunder
	Servisni Zamena svetiljki (vidi stranu 53)		Quattro četverostruki preusmerivač		Sredstvo za uklanjanje kamenca (na bazi limunske kiseline)
	Čišćenje (vidi stranu 50)		Trio Universal ventil za zatvaranje i preklopni ventil		Izbegavajte kontakt sa očima i kožom. U slučaju kontakta sa očima, dobro isperite sa dosta vode.
	elektroinstalater		Trio Universal ventil za zatvaranje i preklopni ventil		Struja uklj. / isklj.
	Održavanje (vidi stranu 54)		Termostat HighFlow		Ispitni znak (vidi stranu 55)
	Ispravnost zaštitne sklopke se mora proveravati u redovnim vremenskim intervalima.		Kapacitet odvoda mora biti veći od 50 l/min.		
			Ispust		
			Sredina tuš-kada		
			Otvorite dotok vode / Zatvorite dotok vode		



Montaža osnovna garnitura (vidi stranu 42)

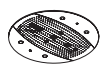

Montaža Završni set (vidi stranu 47)



Sikkerhetshenvisninger

- ⚠ Bruk hansker under montasjen for å unngå klem- og kuttskader.
- ⚠ Produktet skal kun brukes for bade-, hygiene- og kroppshygiene.
- ⚠ Barn og voksne med fysiske og psykiske og/eller sensoriske handicap skal ikke bruke dusjsystemet uten oppsyn. Personer som er påvirket av alkohol eller narkotika skal ikke bruke dusjsystemet.
- ⚠ Dusjstrålen skal ikke komme i kontakt med ømfintlige kroppsdeler (f.eks. øyene). Overhold en tilstrekkelig avstand mellom dusjen og kroppen.
- ⚠ Store trykkdifferanser mellom kaldt- og varmtvannstilkoblinger skal utlignes.

⚡ El-tilkoblinger

- ⚠ El-tilkoblinger skal kun utføres av el-fagfolk!
- ⚠ Installer strømtilførsel 100-240V/N/PE/50-60Hz (lengde: 0,3 m) på forhånd.
- ⚠ Installasjonen skal sikres ved hjelp av en jordfeilbryter (RCD/FI) dimensjonert for en reststrøm på ≤ 30 mA.
- ⚠ Produktet må tilkobles en 4 mm² potensialutjevning (PA).

⚡ El-installatør

- ⚠ Installasjons- og kontrollarbeid skal utføres av en godkjent el-fagbedrift som overholder direktiv VDE 0100 del 701, IEC 60364-6 og IEC 60364-7-70101. samt EN 60335-2-105.
- ⚠ Strømforsyningsledningen må være dobbelt isolert , og settes inn i stikkontakten.

Montagehenvisninger

- Før montasjen skal produktet sjekkes for transportskader. Etter monteringen aksepteres ikke noen transport- eller overflateskader.
- Ledningene og armaturen skal monteres, spyles og sjekkes iht. de gyldige normer.
- Gjeldende retningslinjer for rørleggerarbeid i de enkelte land skal følges.
- Under monteringen av produktet gjort av kvalifisert fagpersonell, skal man påse at monteringsoverflaten på hele festeområdet er plant (ingen utstikkende fuger eller flisekanter), at veggoppbyggingen egner seg for produktmontasjen og ikke viser svake punkter.

- Ved boring skal det passes på strøm- og vannledninger!
- Utløpsytelsen skal være tilstrekkelig dimensjonert.
- Dusjen skal kun monteres etter en avstengingsventil eller etter sanitærramatur.
- Produktet er ikke påtenkt for bruk sammen med et dampbad!

Tekniske data

































Driftstrykk før armatur: maks. 1 MPa
Anbefalt driftstrykk: 0,3 - 0,5 MPa
(1 MPa = 10 bar = 147 PSI)

Varmtvannstemperatur maks. 60 °C
Anbefalt temperatur for varmt vann 42 °C
Sikkerhetssperre 40 °C

Varselshenvisning: Overskridelse av denne temperaturen kan medføre forbrenninger!

Termisk desinfisering: maks. 70 °C / 4 min
Nominell spenning 100-240V AC 50-60Hz
Lamper 4 x LED: 18 W
12V DC SELV 4 W
Beskyttelsesklasse II
Beskyttelsesklasse IPX5

Symbolbeskrivelse

	Ikke bruk silikon som inneholder eddiksyre!		Vanntilkobling DN20		Tomme rør for strømforsyning
	Mål (se side 32)		Varmtvann		Varsel pga. het overflate!
	Montasje-eksempel (se side 34)		Vanntilkobling DN20		Bruk vernehansker
	Betjening (se side 31)		Kaldtvann		Bruk vernebriller
	Service-deler (se side 31)		Innfelt ventil		Natursvamp
	Service Bytte lysmiddel (se side 53)		Quattro fire-veis omstilling		Avkalker (sitronsyrebasert) Unngå øye- og hudkontakt. Hvis produktet skulle komme i kontakt med øynene, skyll dem grundig med vann.
	Rengjøring (se side 50)		Trio universal stenge- og omstillingsventil		Avløp ytelse skal være mer enn 50 l/min.
	El-installatør		Trio High Flow		Avløp
	Vedlikehold (se side 54) Beskyttelses-innretningens funksjon skal sjekkes regelmessig.		Termostat HighFlow		Avløp
			Termostat HighFlow		Midten på dusjkar
			Termostat HighFlow		Vann settes på / Slå av vann
					Strøm på / av
					Prøvemerket (se side 55)

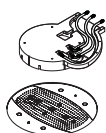

Montasje Basissett (se side 42)

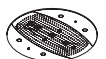

Montasje Ferdigsett (se side 47)



Указания за безопасност

- ⚠ При монтажа трябва да се носят ръкавици, за да се избегнат наранявания поради притискане или порязване.
- ⚠ Позволено е използването на продукта само за къпане, хигиена и цели на почистване на тялото.
- ⚠ Не е позволено деца, както и възрастни с физически, умствени и / или сензорни ограничения да използват продукта без надзор. Не е позволено използването на системата на продукта от лица, употребили алкохол или дрога.
- ⚠ Трябва да се избягва контакта на струите на разпръсквателя с чувствителни части на тялото (напр. очите). Между разпръсквателя и тялото трябва да се спазва достатъчно разстояние.
- ⚠ Големите разлики в налягането между изводите за студената и топлата вода трябва да се изравняват.

⚡ Свързване към електричеството

- ⚠ Свързването към електричество се позволява само от електротехник!
- ⚠ Захранването с напрежение 100-240V/N/PE/50-60Hz (дължина: 0,3 m) се инсталира предварително.
- ⚠ Защитата трябва да се осъществи с предпазен шалтер за остатъчен ток (RCD/ FI) с параметриран диференциален ток ≤ 30 mA.
- ⚠ Продуктът трябва да бъде свързан към налично при инвеститора изравняване на потенциала (PA) 4 mm².

⚡ Електромонтьор

- ⚠ Дейностите по инсталацията и инспекцията следва да бъдат изпълнявани от оторизиран електротехник при спазване на VDE 0100 Част 701, IEC 60364-6 и IEC 60364-7-701 както и на EN 60335-2-105.
- ⚠ Кабелът за свързване към мрежата трябва да бъде вкаран двойно изолиран  в присъединителната кутия.

Указания за монтаж

- Преди монтажа продуктът трябва да се провери за транспортни щети. След монтажа не се признават транспортни или повърхностни щети.
- Тръбопроводите и арматурата трябва да се монтират, промият и проверят в

съответствие с валидните норми.

- Трябва да бъдат спазвани валидните в съответните страни предписания за инсталиране.
- При монтаж на продукта от квалифицирани специалисти да се внимава за това, закрепващата повърхност в целия диапазон на закрепването да бъде равна (без изпъкнали фуги или изместване на плочки), конструкцията на стената да е подходяща за монтаж на продукта и да няма слаби места.
- При пробиването внимавайте за електро- и водопроводите!
- Трябва да се изчисли достатъчна мощност на изтичане.
- Разпръсквателят може да се свърже само след спиращ клапан или санитарна арматура.
- Продуктът не е предвиден за употреба във връзка с парна баня!

Технически данни

Работно налягане преди арматурата:	макс. 1 МПа
Препоръчително работно налягане:	0,3 - 0,5 МПа (1 МПа = 10 bar = 147 PSI)
Температура на горещата вода:	макс. 60 °C
Препоръчителна температура на горещата вода:	42 °C
Предпазна блокировка:	40 °C
Предупредително указание: Надвишаването на температурата може да доведе до изгаряния!	
Термична дезинфекция:	макс. 70 °C / 4 мин
Номинално напрежение	100-240V AC 50-60Hz
Номинална консумируема мощност	18 W
Лампи 4 x LED:	12V DC SELV 4 W
Яркостта на осветителното тяло не може да се регулира.	
Защитен клас	II
Вид защита	IPX5

Описание на символите

	Не използвайте силикон, съдържащ оцетна киселина!		Извод за вода DN20		Тръба за полагане на кабели за електрозахранване
	Размери (вижте стр. 32)		Топла вода		Предупреждение за гореща повърхност!
	Примери за монтаж (вижте стр. 34)		Извод за вода DN20		Носете защитни ръкавици
	Обслужване (вижте стр. 31)		Студена вода		Носете защита за очите
	Сервизни части (вижте стр. 31)		Клапан за мазилка		Естествен сунгер
	Сервиз Смяна на осветителното тяло (вижте стр. 53)		Четирипътно превключване Quattro		Препарат за почистване на варовик (на базата на лимонова киселина)
	Почистване (вижте стр. 50)		Спирателен и превключващ клапан Trio Universal		Избягвайте контакт с очите и кожата. Ако продуктът попадне в очите Ви, изплакнете ги добре с вода.
	Електромонтьор		Термостат HighFlow		Електричество вкл / изкл
	Поддръжка (вижте стр. 54)		Мощността на изтичане трябва да бъде повече от 50 l/min		Контролен знак (вижте стр. 55)
	Функцията на предпазния шалтер трябва да се проверява на редовни интервали.		Отвеждане		Включване на водата / Изключване на водата
			Среда на коритото на душ-кабината		
			X		



Монтаж Основен набор (вижте стр. 42)



Монтаж Готов набор (вижте стр. 47)



Udhëzime sigurie

- ⚠ Për të evituar lëndimet e pickimeve ose të prerjeve gjatë procesit të montimit duhet që të vishni doreza.
- ⚠ Produkti duhet të përdoret vetëm qëllimet e banjave, të higjienës dhe të larjes së trupit.
- ⚠ Fëmijët dhe të rriturit me aftësi të kufizuara fizike, mendore dhe/ose ndijuese nuk duhet ta përdorin produktin pa qenë nën mbikëqyrje. Personat që janë nën ndikimin e drogave ose të alkoolit nuk duhet ta përdorin produktin.
- ⚠ Kontakti i valëve të dushit me pjesët e ndjeshme të trupit (p.sh. me sytë) duhet që të shmanget. Midis dushit dhe trupit duhet që të mbahet një distancë e mjaftueshme.
- ⚠ Ndryshimet e mëdha të presionit mes lidhjeve të ujit të ftohtë dhe atij të ngrohtë duhen ekuilibruar.

Lidhja me rrjetin elektrik

- ⚠ Lidhjet elektrike mund të bëhen vetëm nga elektricisti i specializuar.
- ⚠ Instaloni më parë furnizimin me energji elektrike 100-240V/N/PE/50-60Hz (Gjatësia: 0,3 m).
- ⚠ Sigurimi duhet të kryhet nëpërmjet një pajisjeje mbrojtëse kundër rrjedhjes së rrymës (RCD/ FI) me një vlerësim të rrymës diferenciale $\leq 30\text{mA}$.
- ⚠ Produkti duhet të lidhet në një barazues ekzistues potenciale (PA) 4 mm².

Elektricisti

- ⚠ Punimet e instalimit dhe të kontrollit duhet të realizohen nga një elektricist i autorizuar duke marrë parasysh VDE 0100 Pjesa 701, IEC 60364-6 dhe IEC 60364-7-701 si dhe EN 60335-2-105.
- ⚠ Linja e lidhjes me rrjetin elektrik duhet të jetë dyf sh e izoluar  e futur në kutinë e lidhjes.

Udhëzime për montimin

- Përpara montimit duhet që produkti të kontrollohet për dëmtime nga transporti. Pas instalimit nuk do të njihet asnjë dëmtim nga transporti ose dëmtim i sipërfaqes.
- Tubacionet dhe rubinetet duhet që të montohen, të shpëlahen dhe të kontrollohen

sipas standardeve në fuqi

- Duhet të respektohen linjat udhëzuese të instalimit, të vlefshme për vendet respektive.
- Gjatë montimit të produktit nga teknikët e specializuar duhet mbajtur parasysh që sipërfaqja e montimit gjendet brenda zonës së përgjithshme të planit të montimit (nuk ka vendbashkime të dala ose mospërputhje të pllakave), që struktura e murit është e përshtatshme për montimin e produktit dhe që nuk paraqet asnjë pikë të dobët.
- Gjatë shpimit bëni kujdes për të gjitha linjat elektrike dhe tubacionet e ujit!
- Kapaciteti i rrjedhjes duhet dimensionuar në mënyrë të mjaftueshme.
- Dushi duhet të jetë i lidhur/montuar vetëm pas një ventili (valvule) bllokuese ose pajisjeje sanitare.
- Pajisja nuk është parashikuar për përdorim në lidhje me një banjë me avull!

Të dhëna teknike

Shtypja para armaturës:	maks. 1 MPa
Presioni i rekomanduar:	0,3 - 0,5 MPa (1 MPa = 10 bar = 147 PSI)
Temperatura e ujit të ngrohtë	maks. 60 °C
Temperatura e rekomanduar e ujit të ngrohtë:	42 °C
Bllokada e sigurisë	40 °C































Paralajmërimi Tejkalimi i kësaj temperature mund të shkaktojë djegie!

Dezinfektim Termik:	maks. 70 °C / 4 min
Tensioni nominal	100-240V AC 50-60Hz
Konsumi i punës	18 W
Ndriçuesit 4 x LED:	12V DC SELV 4 W

Mjeti ndriçues nuk është i kontrollueshëm.

Klasa e mbrojtjes	II
Lloji i mbrojtjes	IPX5

Përshkrimi i simbolit

 Mos përdorni silikon që në përbërje ka acid acetik.	 Lidhja me rrjetin e ujit DN20	 Tubi bosh për furnizimin me energji elektrike
 Përmasat (shih faqen 32)	 Uji i ngrohtë	 Paralajmërimi për sipërfaqen e nxehtë!
 Shembuj të montimit (shih faqen 34)	 Lidhja me rrjetin e ujit DN20	 Vendosi doreza mbrojtëse
 Përdorimi (shih faqen 31)	 Uji i ftohtë	 Vendosi mbrojtëse për sytë
 Pjesët e servisit (shih faqen 31)	 Ventili i suvajës	 Sfungjer natyral
 Servisi Ndërrimi i llambës (shih faqen 53)	 Valvul devijuese Quattro me katër drejtime	 Largues bigorri (me bazë acidi citrik)
 Pastrimi (shih faqen 50)	 Valvul universale Trio për bllokim dhe devijim	 Shmangni kontaktin me sytë dhe lëkurën. Nëse produkti bie në kontakt me sytë, shpëlaheni ato mirë me ujë të bollshëm.
 Elektricisti	 Trio High Flow	 Korrenti kyçur / shkyçur
 Mirëmbajtja (shih faqen 54)	 Kapaciteti i shkarkimit duhet të jetë më shumë se 50 l/min.	 Shenja e kontrollit (shih faqen 55)
 Mbrojtja duhet të kontrollohet në hapësira të rregullta kohore për funksionimin e tij.	 Shkarkimi	
	 Raindrain X	
	 Hapni ujin / Mbyllni ujin.	

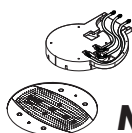

Montimi Komplet bazë (shih faqen 42)

Montimi Komplet i gatshëm (shih faqen 47)

تنبيهات الأمان

- عند التركيب بواسطة عمال تركيب متخصصين يجب الإنتباه إلى أن مساحة التثبيت في مكان التركيب بوجه عام مسطحة (لا توجد روابط أو فروق للربط بين البلاطات). لذا يجب التأكد من أن الحائط الذي سيتم تركيب المنتج عليه صالح لذلك وأنه لا يوجد به نقاط ضعف.
- يجب الحذر عند الثقب فوق وصلات كهرباء أو مياه!
- يجب أن يكون الأداء من حيث حجز الفضلات ذا حجم مناسب.
- يسمح بتوصيل الدش فقط بعد صمام حبس الماء أو بعد خلط الماء.
- لا يستخدم المنتج مع حمام بخار!

الحد الأقصى 1 ميجاباسكال
0,5 - 0,3 ميجاباسكال
(1 ميجاباسكال = 10 بار = 147 PSI)

الحد الأقصى 60°C
42°C
40°C

درجة حرارة الماء الساخن:
درجة الحرارة الموصى بها للماء الساخن:
حفظ أمان
تحذير: يمكن أن يؤدي تخطي درجة الحرارة هذه إلى إحتراقات!
تقديم حراري:
الحد الأقصى 70°C / 4 الدقيقة
الجهد الاسمي
الاستهلاك الاسمي
المصابيح 4 LED x
مصباح الإنارة ليس عاكس للضوء.
فئة الحماية
نوع الحماية

II
IPX5

- ⚠ يجب ارتداء قفازات لليد أثناء التركيب لتجنب حدوث أخطار الإنحشار أو الجروح.
- ⚠ لا يجب استخدام المنتج إلا في أغراض الاستحمام والأغراض الصحية وأغراض تنظيف الجسم.
- ⚠ لا يسمح لأي أطفال أو أفراد بالغين يعانون من إعاقات بدنية أو ذهنية أو حسية أو يعانون من جميع هذه الإعاقات باستخدام المنتج إلا تحت إشراف آخرين. كما أنه لا يسمح لأي شخص تحت تأثير تناول الكحول أو المخدرات باستخدام نظام الدش.
- ⚠ يجب تجنب حدوث إتصال مباشر بين الماء الخارج من رأس الدش وبين أجزاء الجسم الحساسة (مثل العينين). يجب وجود مسافة كافية بين رأس الدش والجسم.
- ⚠ يجب أن يكون تيار الماء الساخن والماء البارد متعادلين في الضغط.

توصيلة كهربائية

- ⚠ لا يجوز القيام بالتوصيلات الكهربائية إلا عن طريق فني كهرباء متخصص!
- ⚠ يتم التركيب المسبق لخطوط إمدادات الطاقة 60Hz-240V/N/PE/50-100 (طول: 0,3 م).
- ⚠ يتم التأمين من خلال تجهيزة حماية ضد اختلاف التيار (RCD/ FI) عند اختلاف التيار لأقل من أو يساوي 30 مللي أمبير.
- ⚠ يجب أن يكون المنتج موصلا بموصل ربط متساوي الجهد (PA) متاحاً في الموقع 4باسكال/ ميللي متر مربع.

مختص تركيب إلكترونيات

- ⚠ يتعين القيام بكافة أعمال التركيب والفحص من قبل فني كهرباء معتمد مع الأخذ في الاعتبار الالتزام بالمعيار VDE 0100 الجزء 701 و 60364-IEC 6 و 60364-IEC 701-7 وكذلك 105-2-EN 60335.
- ⚠ يجب وضع كابل التيار الكهربائي في المقبس ويكون معزولاً عزلاً مزدوجاً.

تعليمات التركيب

- قبل القيام بعملية التركيب، يجب فحص المنتج للتأكد من خلوه من أية تلفيات ناتجة عن النقل. بعد القيام بعملية التركيب، لن يتم الاعتراف بوجود أية تلفيات سطحية أو تلفيات ناتجة عن عملية النقل.
- يجب تركيب وغسيل واختبار التوصيلات وخلطات المياه طبقاً للمعايير السارية.
- يجب مراعاة القواعد الخاصة بالتركيب وأعمال السباكة وفقاً للوائح الخاصة بكل بلد.

وصف الرمز

أنبوب أسلاك لكابلات التيار		توصيلة مياه DN20 ماء دافئ		هام! لا تستخدم السليكون الذي يحتوي على أحماض!	
سطح ساخن!		توصيلة مياه DN20 ماء بارد		أبعاد (راجع صفحة 32)	
يجب ارتداء قفازات الحماية		صمام التدفق		مثال على التركيب (راجع صفحة 34)	
يجب ارتداء تجهيزات حماية العين		تغيير مسار رباعي كواترو		التشغيل (راجع صفحة 31)	
إسفنجة طبيعية		صمام حجز وتغيير تريبو يونيفرسال		قطع الغيار (راجع صفحة 31)	
مزيل تكلس (بحامض الليمون) يجب تجنب ملامسة المنتج للعين والجلد. وفي حالة ملامسة المنتج للعين يجب غسلها جيداً بالماء.		ثرموستات HighFlow		الصيانة إستبدال وسيلة الإضاءة (راجع صفحة 53)	
تشغيل/ إيقاف الكهرباء		يجب أن تكون قدرة الصرف أكبر من 50 لتر/دقيقة		التنظيف (راجع صفحة 50)	
شهادة اختبار (راجع صفحة 55)		تصريف		مختص تركيب إلكترونيات	
		بانيو مزود بدش في المنتصف		الصيانة (راجع صفحة 54) يلزم فحص تجهيزة الحماية على فترات منتظمة من حيث سلامة أدائه الوظيفي.	
		افتح خلط الماء. / قم بإيقاف المياه			

التركيب المجموعة الرئيسية (راجع صفحة 42)

التركيب مجموعة كاملة. (راجع صفحة 47)



Rainmaker

26115000 / 26117000 /
28403000 / 28404000

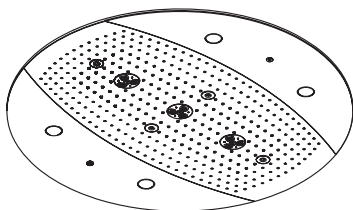

RainAir

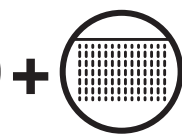
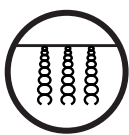
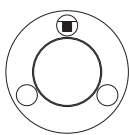

**WhirlAir +
RainAir XXL**

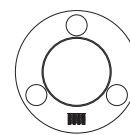

RainAir XXL

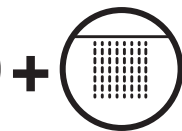
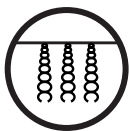
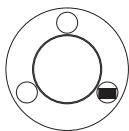

**WhirlAir +
RainAir**

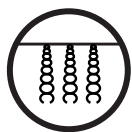
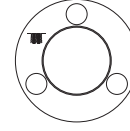

WhirlAir

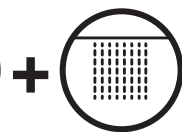

**RainAir XXL +
RainAir**

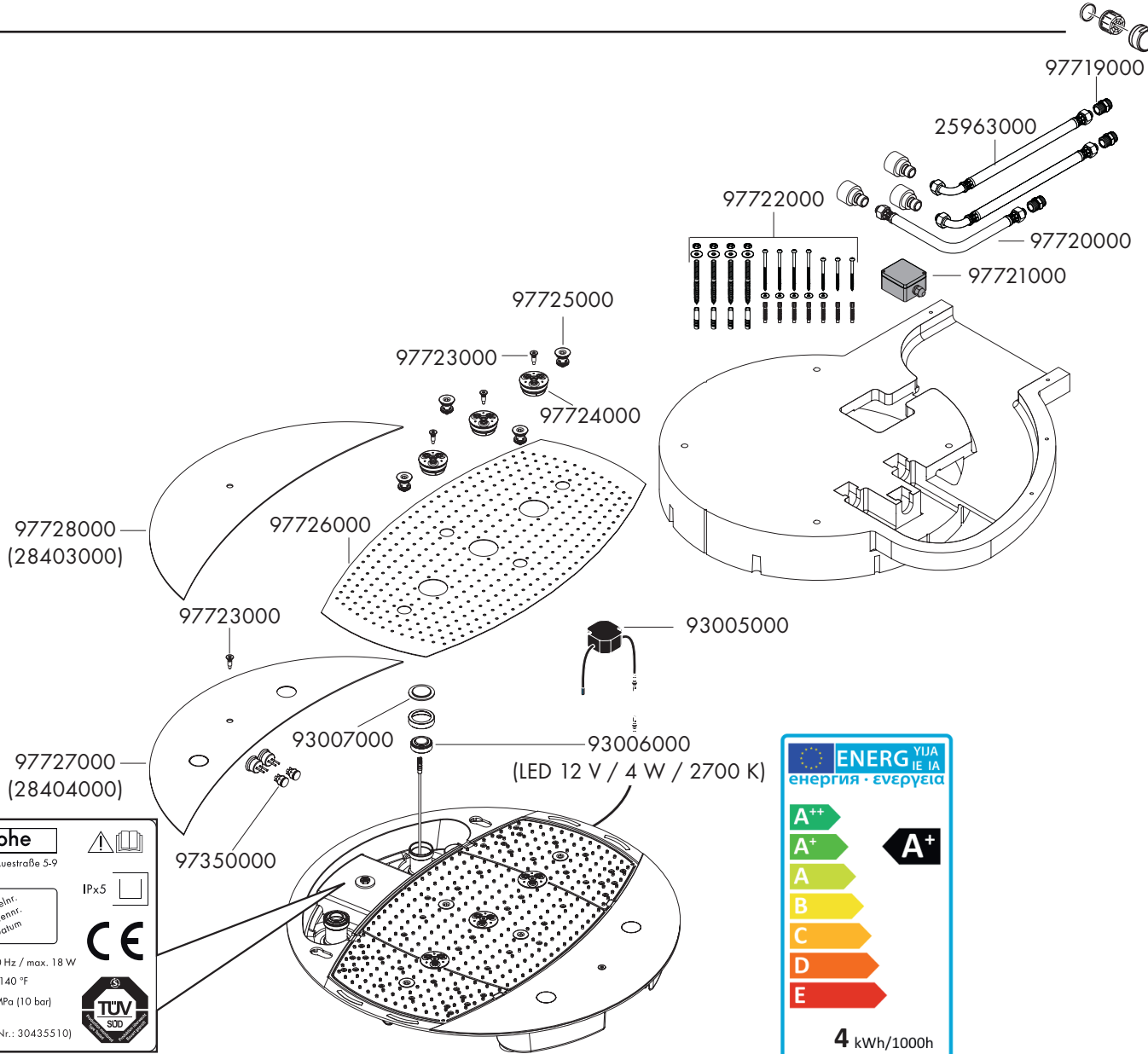
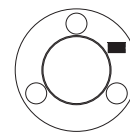

hansgrohe
D-77761 Schiltach, Austraße 5-9
Type: Rainmaker
Art.-No. Artikelnr.
Ser.-No. Seriennr.
Datum
IPx5
CE
TUV SUD
100 - 240 V AC / 50 - 60 Hz / max. 18 W
max = 60 °C / 140 °F
max = 1 MPa (10 bar)
4 x 4 W (Produkt-Nr.: 30435510)

ENERGY LABEL
енергия · енергетика
A++
A+
A
B
C
D
E
A+
4 kWh/1000h

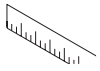

Rainmaker

26117000 / 28404000 / 2841218X

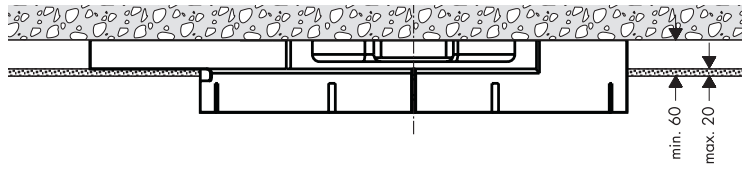
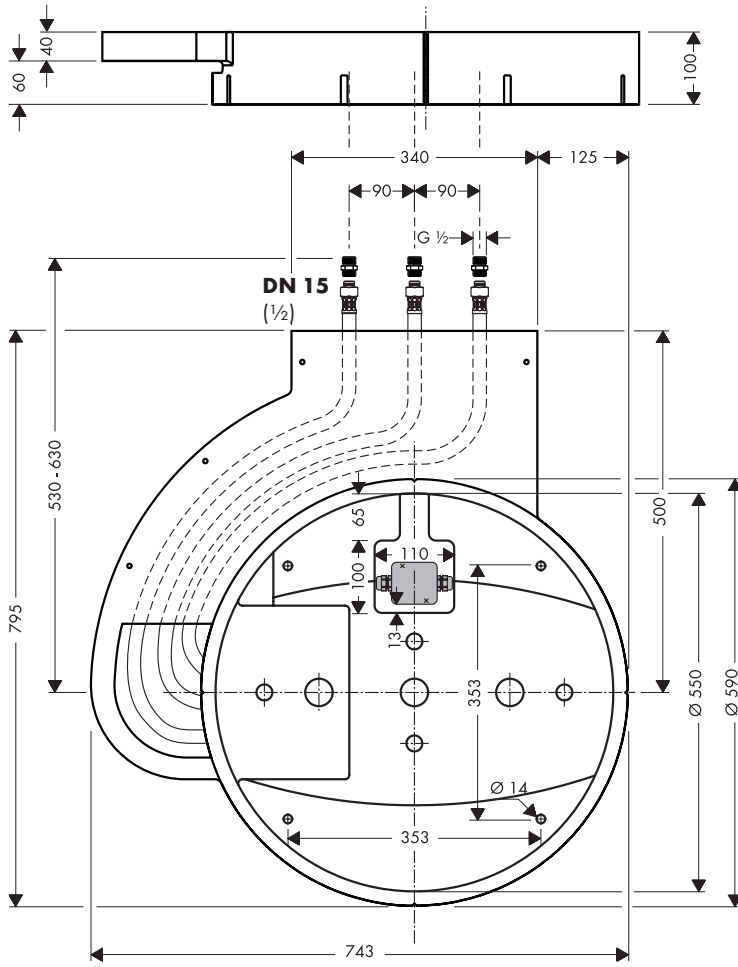

Rainmaker

26115000 / 28403000 / 2841218X

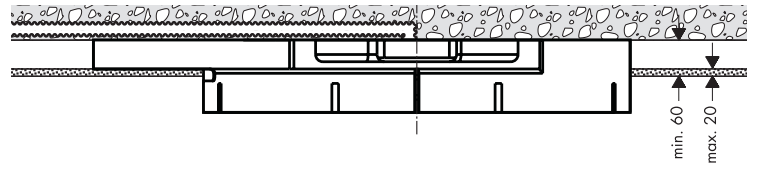
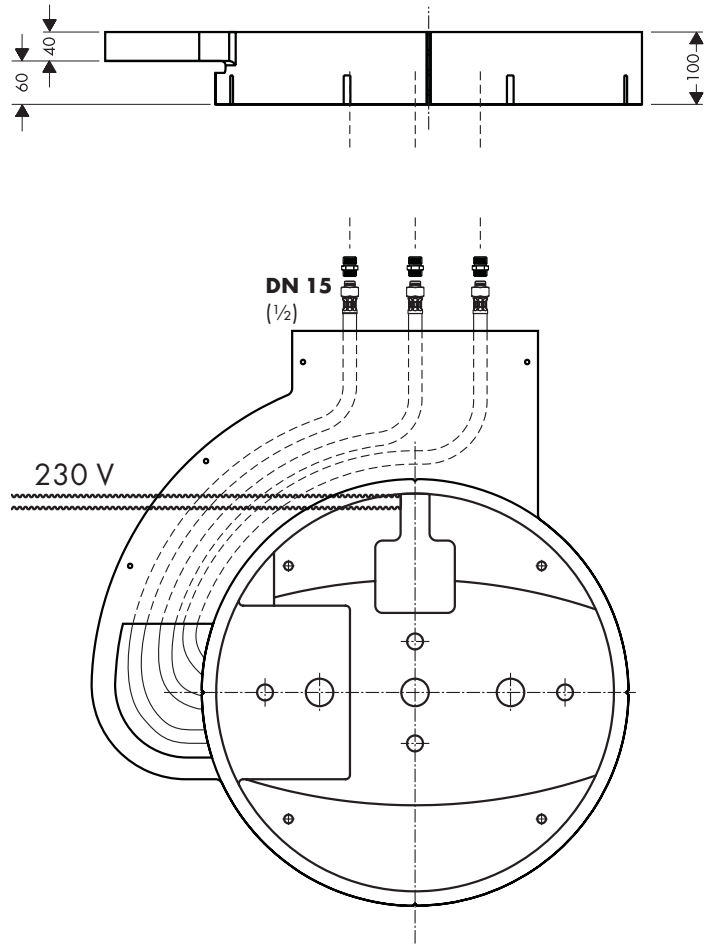



Rainmaker

26115000 / 26117000 / 28403000 / 28404000

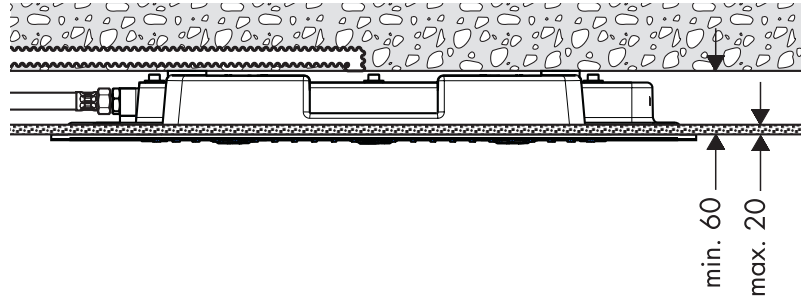
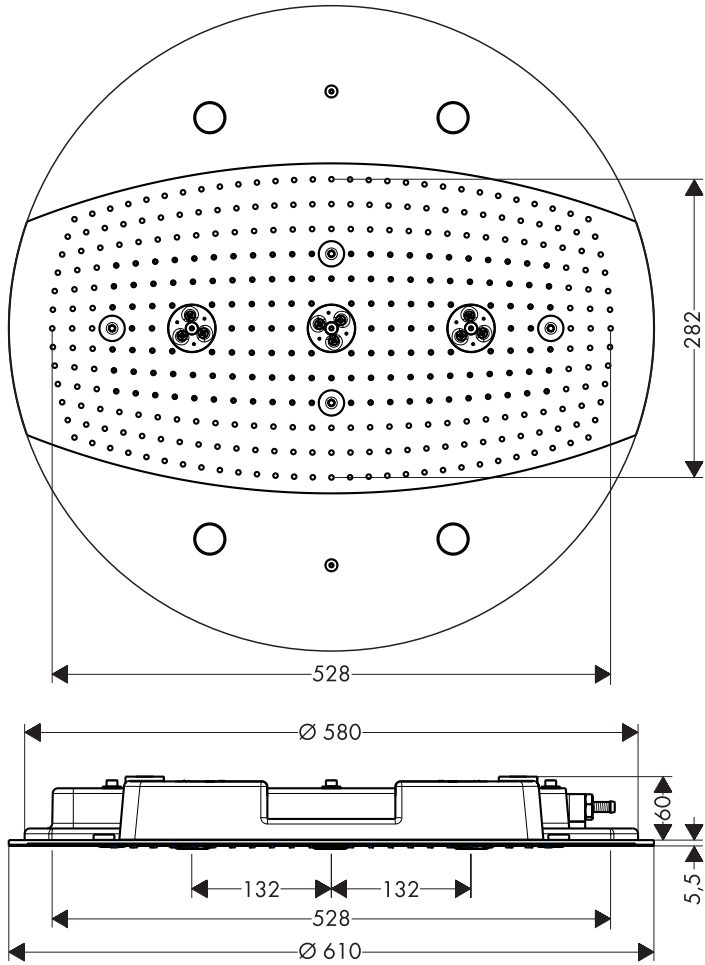

Rainmaker

28403000
28404000

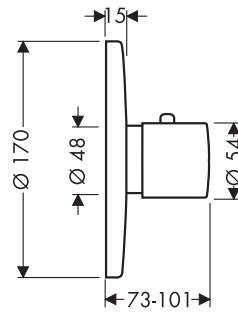



RainAir

RainAir XXL

WhirlAir

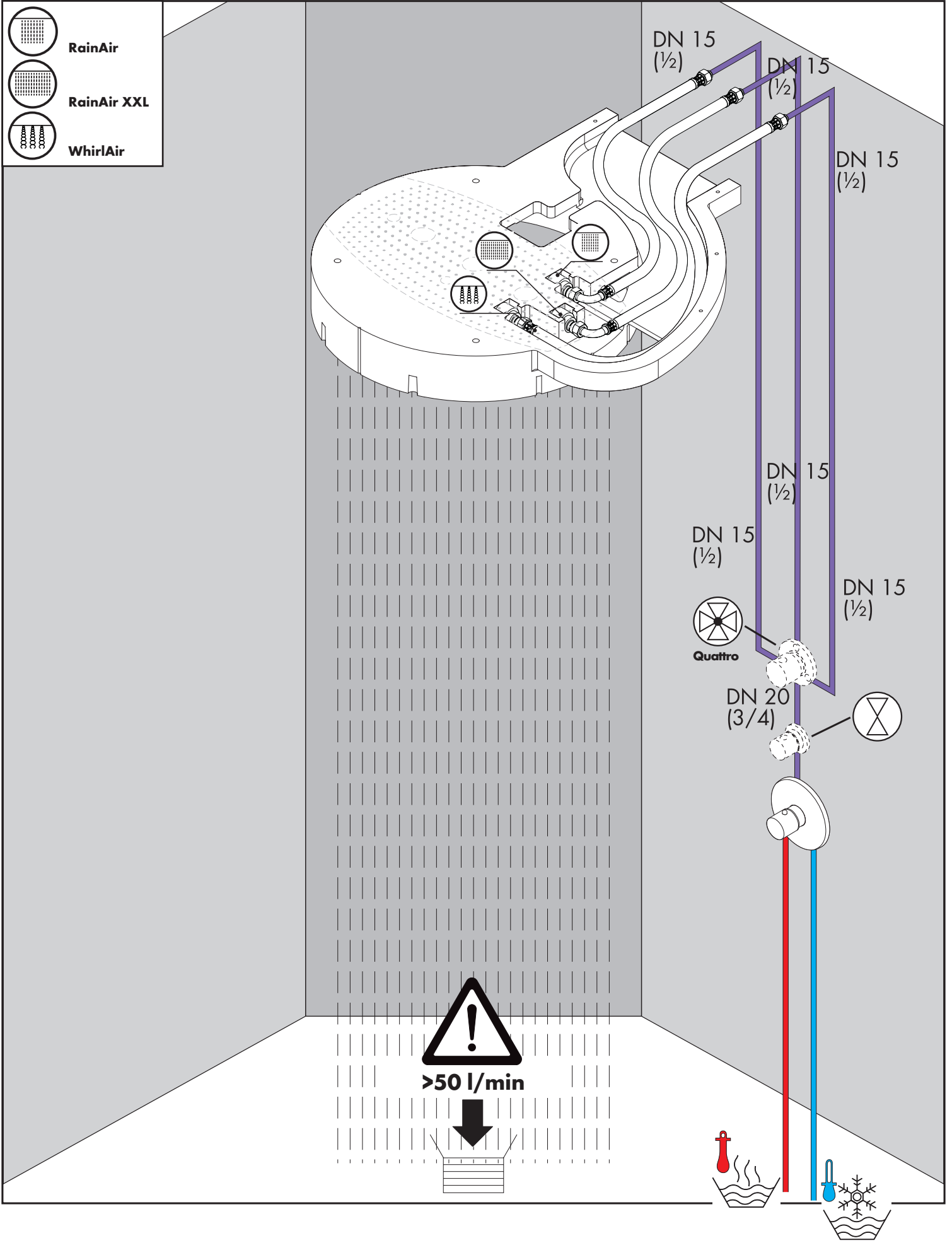

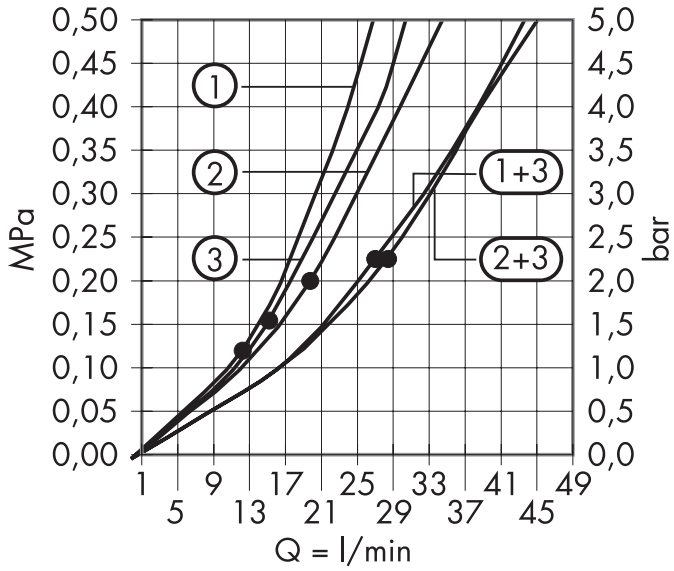

Raindance Rainmaker

- ① = RainAir
- ② = RainAir XXL
- ③ = WhirlAir
- ①+③ = RainAir + WhirlAir
- ②+③ = RainAir XXL + WhirlAir

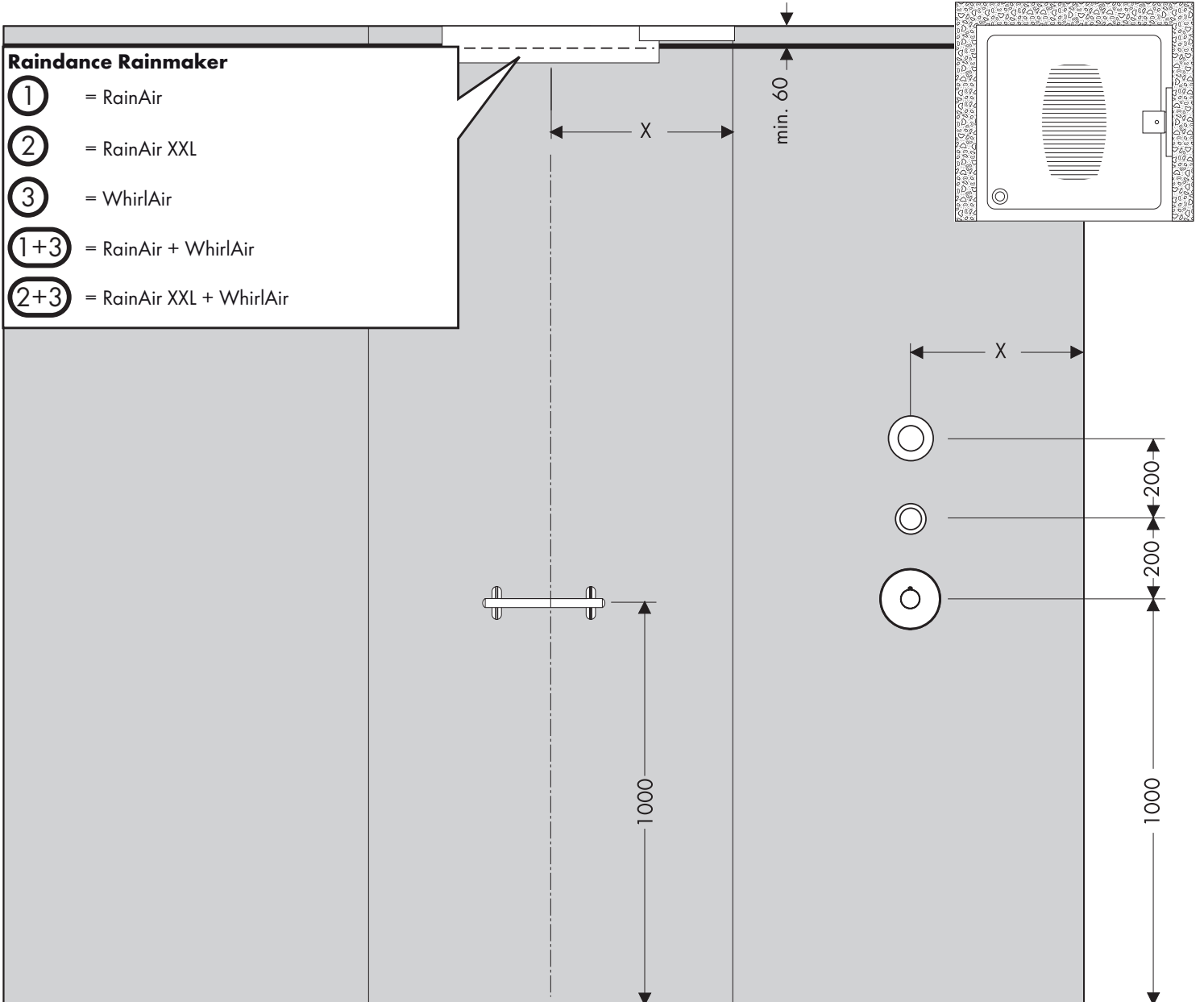



RainAir

RainAir XXL

WhirlAir

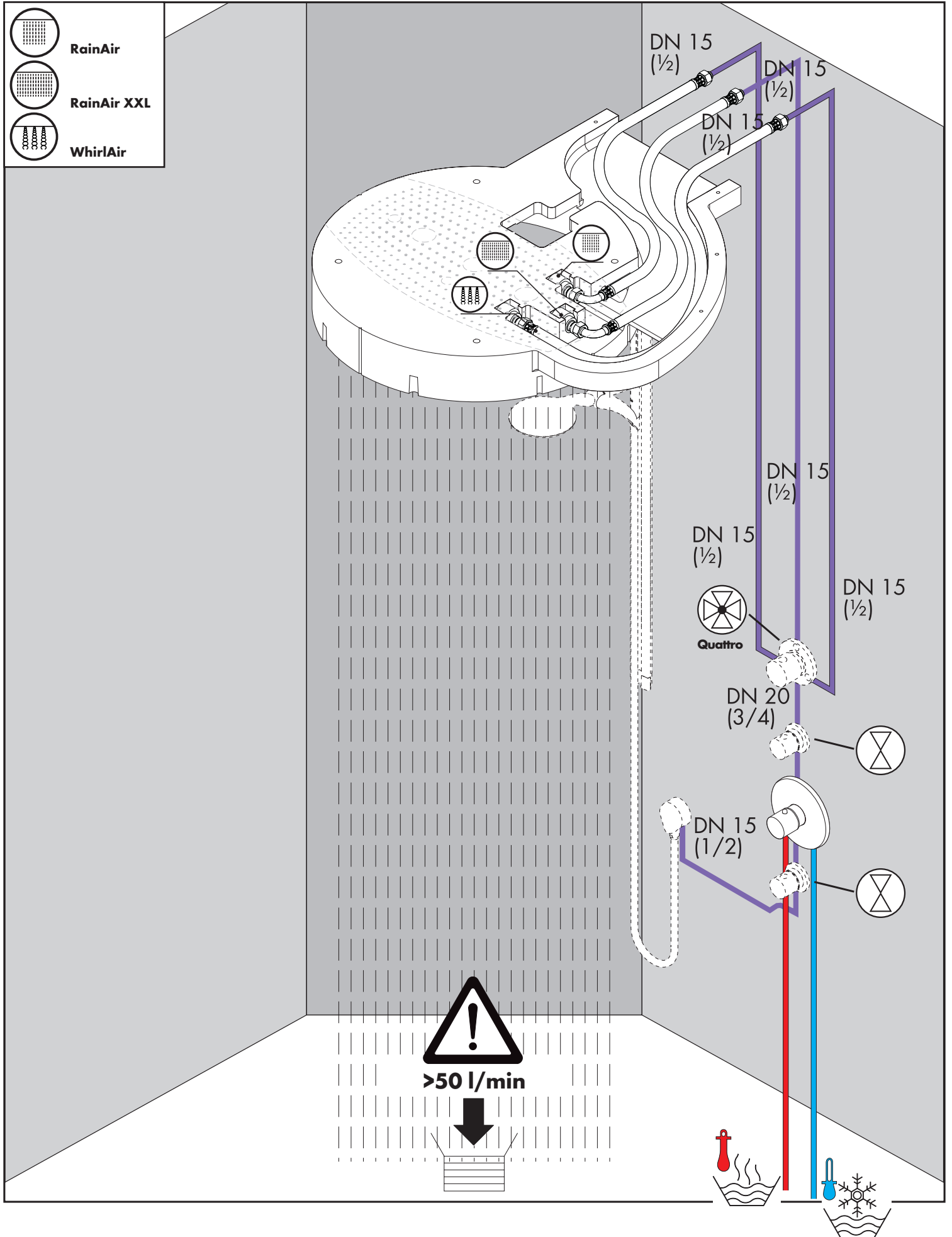

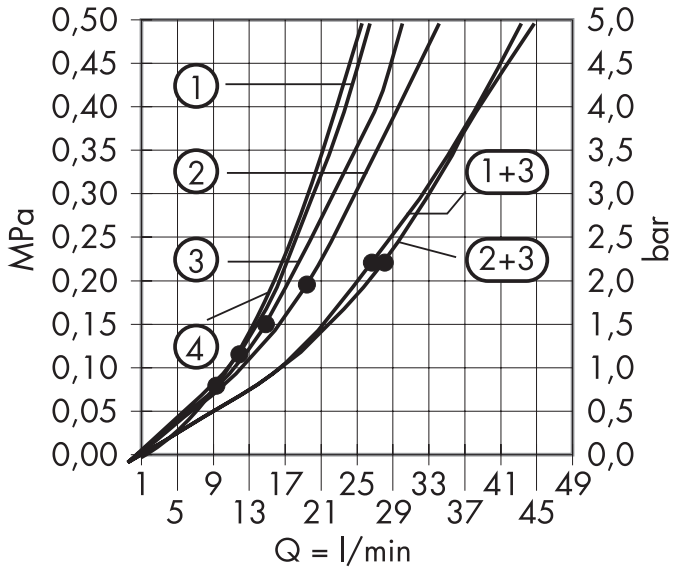

Raindance Rainmaker

- ① = RainAir
- ② = RainAir XXL
- ③ = WhirlAir
- ①+③ = RainAir + WhirlAir
- ②+③ = RainAir XXL + WhirlAir

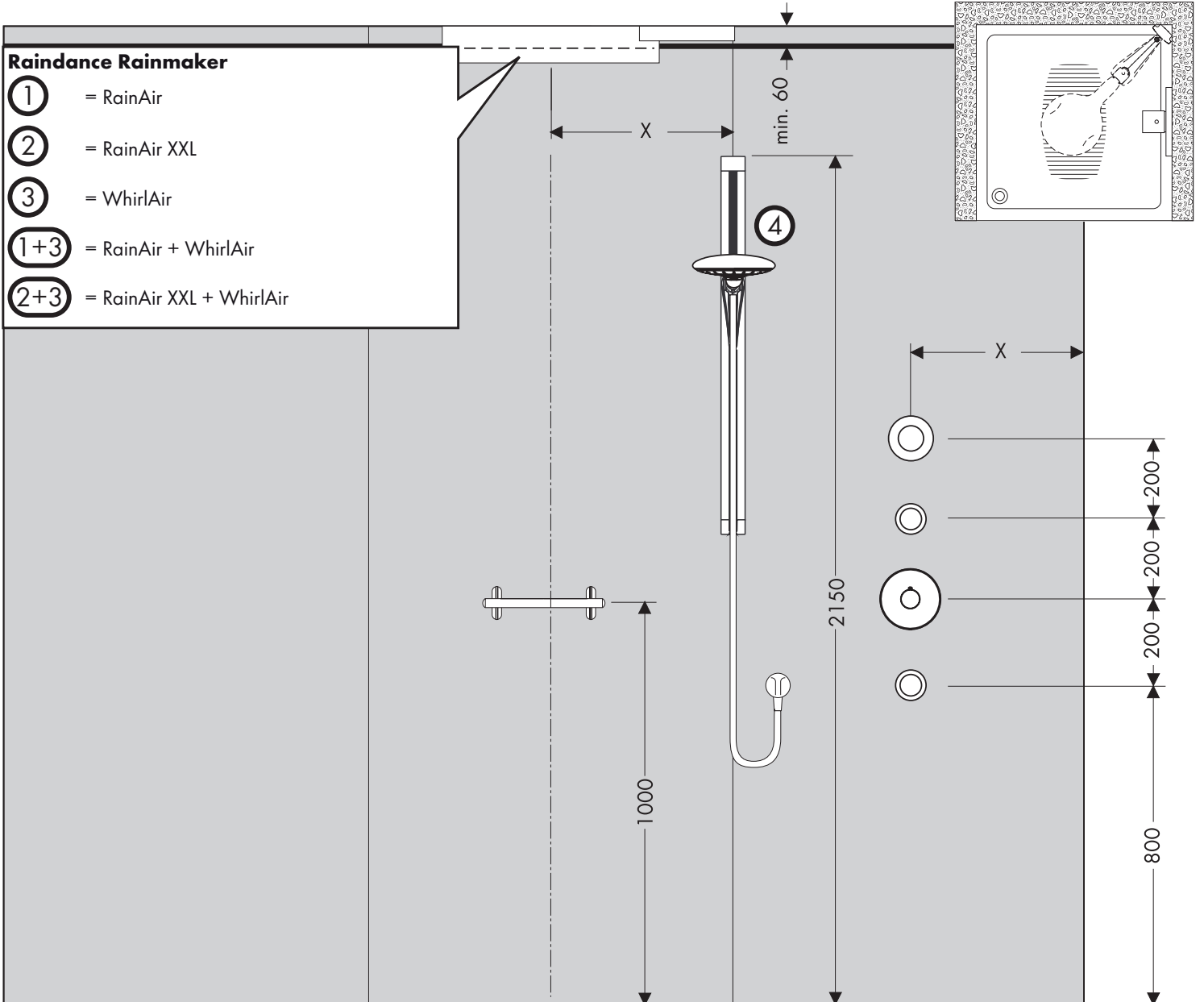

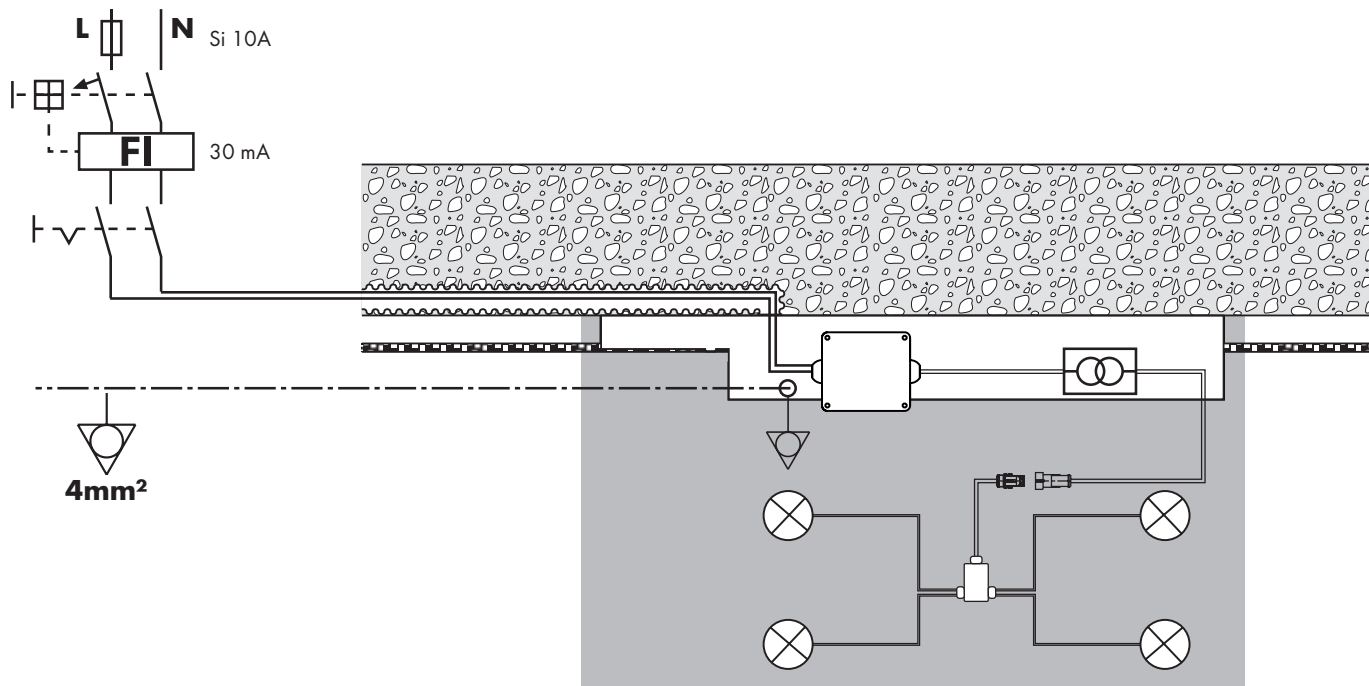

	PA /	N	L							
DE	Potentialausgleich (PA) 4 mm	Neutralleiter	Außenleiter	FI-Schutzschalter 30 mA	Lichtschalter	Anschlussdose	Netzteil 100 - 240V AC 18 W / 12V DC SELV	Leuchtmittel	Steckverbindungen	Verteilerbox
FR	Compensation de potentiel (PA) 4 mm	Neutre	Conducteur	Disjoncteur FI 30 mA	Interrupteur boîtier de raccordement	transformo 100 - 240V AC 18 W / 12V DC SELV	Moyen d'éclairage	Connecteur	Distributeur	
EN	Potential equalisation (PA) 4 mm	neutral conductor	conductor	FI protective switch 30 mA	light switch	junction box	transformer 100 - 240V AC 18 W / 12V DC SELV	illuminant	connectors	distributor box
IT	Compensazione di potenziale (PA) 4 mm	conduttore neutro	conduttore	interruttore di sicurezza per correnti di guasto 30 mA	interruttore luce	scatola di raccordo	trasformatore 100 - 240V AC 18 W / 12V DC SELV	Lampada	collegamenti a spina	cassetta distribuzione
ES	Protección equipotencial (PA) 4 mm	Conductor neutro	Conductor	Commutador de protección FI 30 mA	Interruptor de luz	Caja de conexión	Transformador 100 - 240V AC 18 W / 12V DC SELV	Luces	Uniones insertables	Caja de distribución
NL	Potentialvereffening (PA) 4 mm	Nulgeleider	Geleider	FI-veiligheidsschakelaar 30 mA	Lichtschakelaar	aansluiting	trafo 100 - 240V AC 18 W / 12V DC SELV	Verlichtingsmiddel	Steekverbinding	Verdeelbox
DK	Potentialudligning (PA) 4 mm	Nulleleder	Leder	FI-beskyttelseskontakt 30 mA	lyskontakt	Tilslutningsdåse	Transformer 100 - 240V AC 18 W / 12V DC SELV	lyskilde	Stikforbindelser	Fordelingskasse
PT	Ligação equipotencial (PA) 4 mm	Condutor neutro	Condutor	Interruptor FI 30 mA	Interruptor de luz	Caixa de derivação	Transformador 100 - 240V AC 18 W / 12V DC SELV	Lâmpada	Tomadas de ligação	Caixa de distribuição
PL	Wyrównanie potencjału (PA) 4 mm	Przewód zerowy	Przewód	Wyłącznik różnicowoprądowy FI 30 mA	Wyłącznik oświetleniowy	Przyłącze	Transformator 100 - 240V AC 18 W / 12V DC SELV	Źródło światła	Połączenia wtykowe	Skrzynka połączeniowa
CS	Vyrovnaní potenciálů (PA) 4 mm	Nulový vodič	Vodič	Ochranný spínač FI 30 mA	Spínač světla	připojovací krabice	Transformátor 100 - 240V AC 18 W / 12V DC SELV	Osvětlovací prostředek	Konektorová spojení	Krabička rozdělovače
SK	Vyrovnanie potenciálov (PA) 4 mm	Nulový vodič	Vodič	FI ochranný spínač 30 mA	Svetelný spínač	pripájacia krabica	Transformátor 100 - 240V AC 18 W / 12V DC SELV	Osvetlovací prostriedok	Konektorové spojenia	Skrinka rozdeľovača
ZH	电位均衡 (PA) 4 mm	零线	导线	FI保护开关 30 mA	照明开关	接线盒	变压器 100 - 240V AC 18 W / 12V DC SELV	灯具	插座连接	分线盒
RU	Выравнивание потенциалов (PA) 4 mm	Нулевой провод	Провод	Защитное реле FI 30 mA	Выключатель освещения	точка подключения	трансформатор 100 - 240V AC 18 W / 12V DC SELV	Осветительное средство	Штекерные соединения	Распределительная коробка
HU	Potenciálkiegyenlítés (PA) 4 mm	Nullavezeték	Vezeték	FI-védőkapcsoló 30 mA	Világításkapcsoló	Csatlakozó doboz	Trafó 100 - 240V AC 18 W / 12V DC SELV	Világítás	Dugaszoló csatlakozások	Elosztó doboz
FI	Potentialitasaus (PA) 4 mm	Nollajohdin	Johdin	FI-suojakytkin 30 mA	Valokytkin	Liitäntärasia	Muuntaja 100 - 240V AC 18 W / 12V DC SELV	Valonlähde	Pistokeliitäntä	Jakorasia

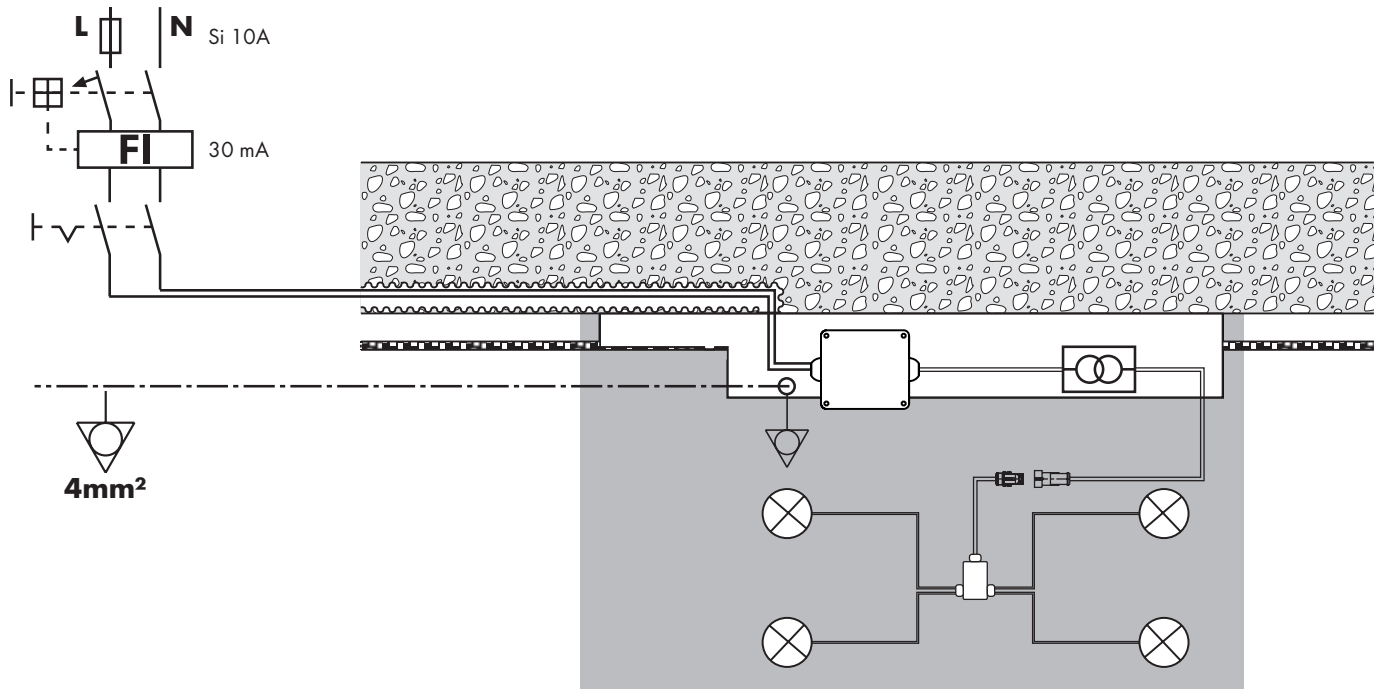

	PA /	N	L							
SV	Potentialutjämning (PA) 4 mm	Neutralledare	Ledare	Jordfelsbrytare 30 mA	Strömbrytare	Anslutningsdosa	Transformator 100 - 240V AC 18 W / 12V DC SELV	Glödlampa	Stickanslutning	Fördelare
LT	Potencialu išlyginimas (PA) 4 mm	nulinis laidas	laidas	FI apsauginis jungiklis 30 mA	elektros jungiklis	Prijungimo dėžutė	Transformatorius 100 - 240V AC 18 W / 12V DC SELV	Šviesos šaltinis	kištukinės jungtys	skirstomoji dėžutė
HR	Izjednačenje potencijala (PA) 4 mm	Nulti vodič	Vodič	FI-sklopka 30 mA	Prekidač za svjetlo	utičnica	transformator 100 - 240V AC 18 W / 12V DC SELV	Rasvjetno tijelo	Utični spojevi	Razdjelna kutija
TR	Potansiyel dengelemesi (PA) 4 mm	Sıfır iletken	İletken	FI koruma şalteri 30 mA	Işık şalteri	Bağlantı kutusu	Trafo 100 - 240V AC 18 W / 12V DC SELV	Ampul	Soket bağlantıları	Dağıtıcı kutu
RO	Egalizare de potențial (PA) 4 mm	Fir neutru	Conductor	Înterupător de protecție FI 30 mA	Înterupător de lumină	Cutie de racord	Transformator 100 - 240V AC 18 W / 12V DC SELV	Lumină	Conexiuni	Cutie de distribuție
EL	Εξισωση δυναμικού (PA) 4 mm	Ουδέτερος Αγωγός		Διακόπτης προστασίας FI 30 mA	Διακόπτης φωτισμού	Κουτί σύνδεσης	Trafo (μετασχηματιστής) 100 - 240V AC 18 W / 12V DC SELV	Φωτιστικό	Ηλεκτρικοί συνδέτηρες	Κουτί διανομής
SL	Potencialna izenačitev (PA) 4 mm	Ničelni vodnik	Vodnik	Zaščitno tokovno stikalo 30 mA	Stikalo za luč	Priključnica	Trafo 100 - 240V AC 18 W / 12V DC SELV	Svetilo	Vtične povezave	Razdelilna doza
ET	Potentsiaali tasakaalustamine (PA) 4 mm	neutraaljuhe	juhe	kaitse 30 mA	valguslüli	harukarp	transformaator 100 - 240V AC 18 W / 12V DC SELV	Valgusti	pistikühendused	harukarp
LV	Potenciāla izlīdzināšana (PA) 4 mm	nulles vads	vads	drošinātājs 30 mA	gaismas slēdzis	Pieslēguma rozete	Transformators 100 - 240V AC 18 W / 12V DC SELV	Apgaismes ķermenis	spraudkontakti	sadales kārba
SR	Izjednačenje potencijala (PA) 4 mm	Nulti provodnik	Provodnik	FI-sklopka 30 mA	Prekidač za svetlo	utičnica	transformator 100 - 240V AC 18 W / 12V DC SELV	Svetiljka	Utični spojevi	Razvodna kutija
NO	Potentialutjevning (PA) 4 mm	Nullleder	Leder	FI-vernebryter 30 mA	Lysbryter	Koblingskontakt	Transformator 100 - 240V AC 18 W / 12V DC SELV	Lysmiddel	Pluggforbindelse	Fordelerboks
BG	Изравняване на потенциала (PA) 4 mm	Нулев проводник	Проводник	Защитен прекъсвач погрешен ток 30 mA	Прекъсвач за осветлението	Присъединителна кутия	Трансформатор 100 - 240V AC 18 W / 12V DC SELV	Осветително тяло	Щепселни съединения	Разпределителна кутия
SQ	Barazimi i potencialeve (PA) 4 mm	Lidhja neutrale	Lidhje	Çelësi mbrojtës FI 30 mA	Çelësi i dritës	Kutia lidhëse	Trafo 100 - 240V AC 18 W / 12V DC SELV	Ndriçuesi	Lidhjet e prizave	Kutia shpërndarëse

	PA /	N	L							
AR	معادلة الجهد الكهربائي 4mm (PA)	الموصل المحايد	موصل	مفتاح حماية FI 30 mA	مفتاح إضاءة	نقطة التوصيل	محول 100 - 240V AC 18W / 12V DC SELV	مادة إضاءة	توصيلات قابسية	صندوق توزيع

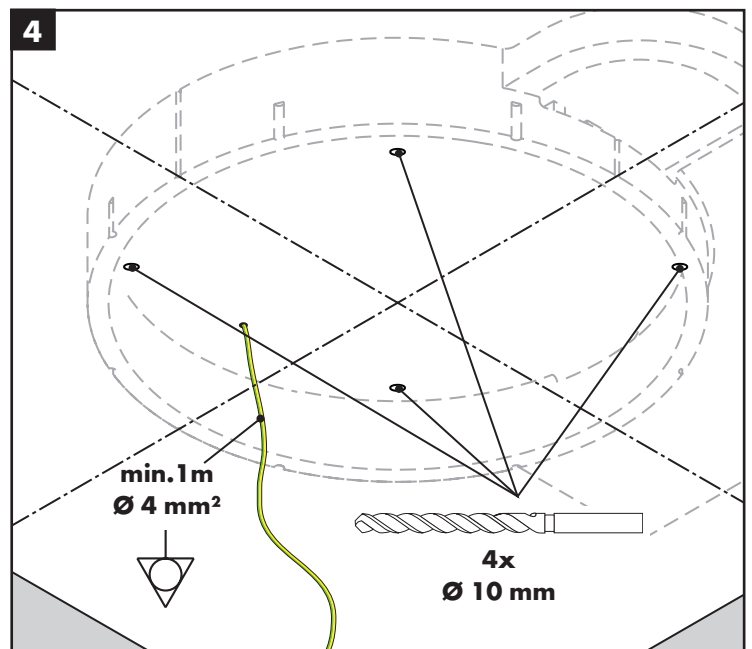
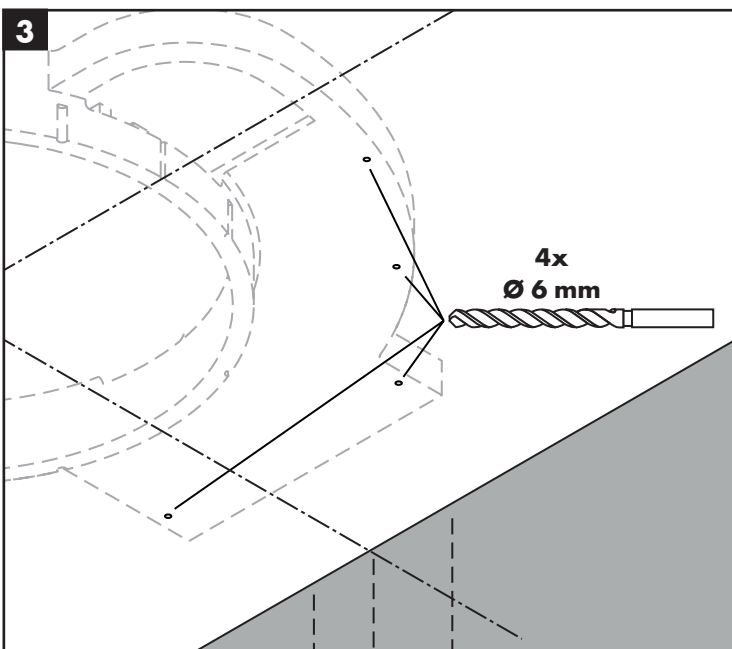
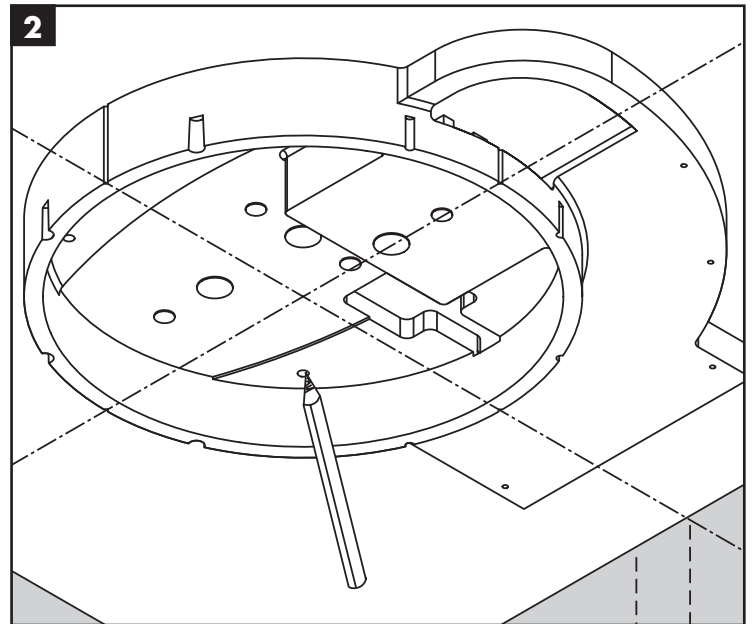
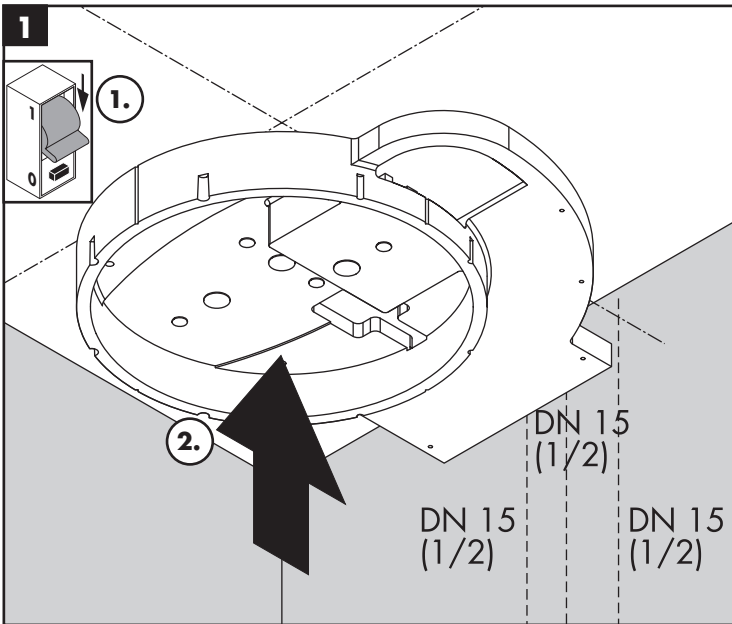
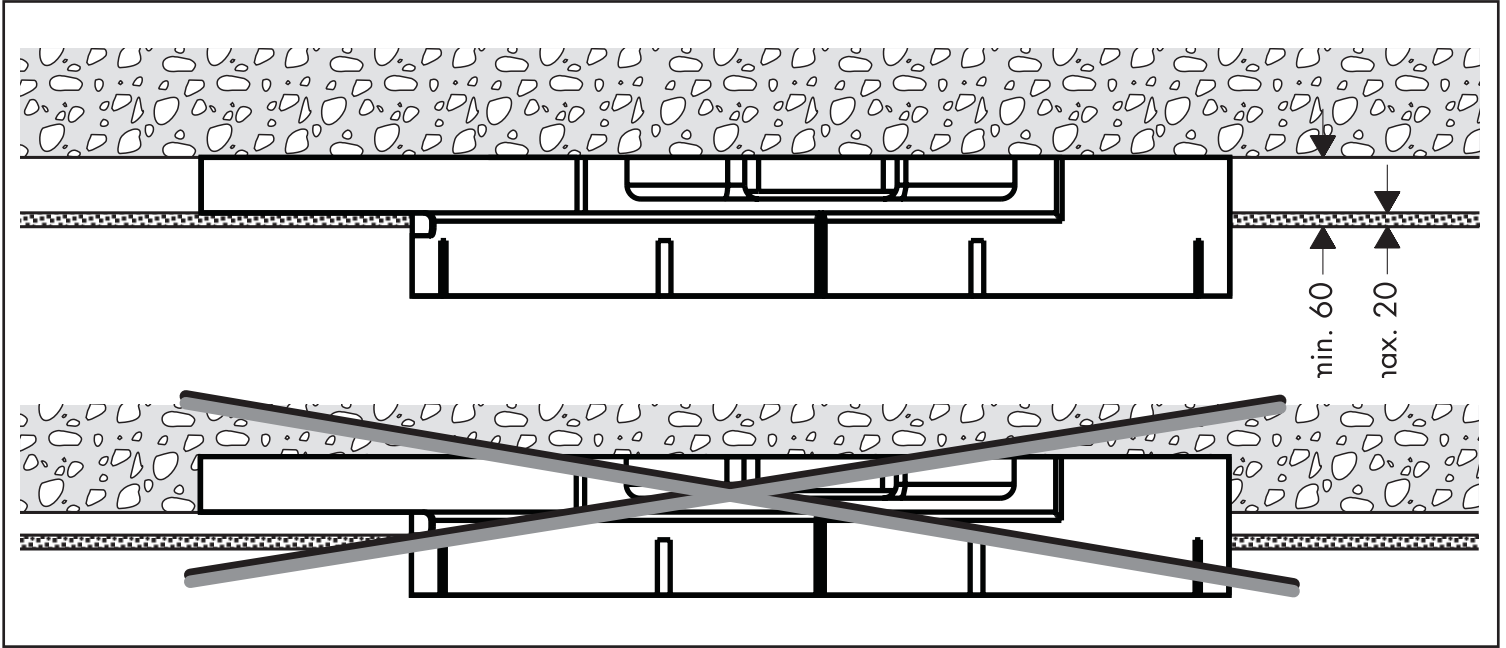

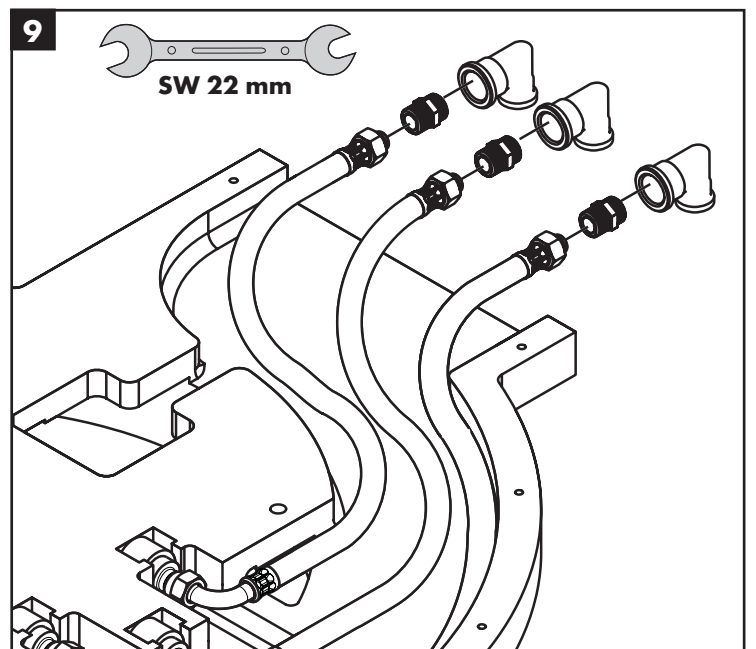
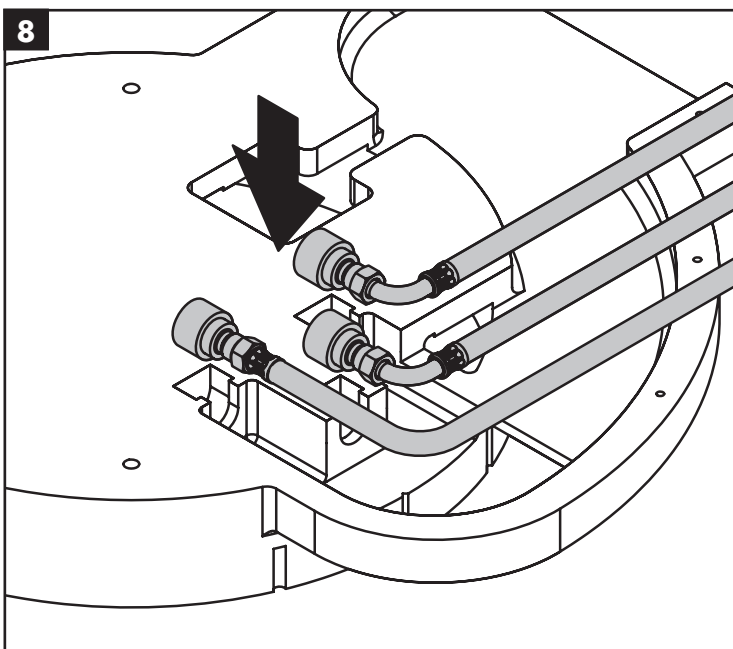
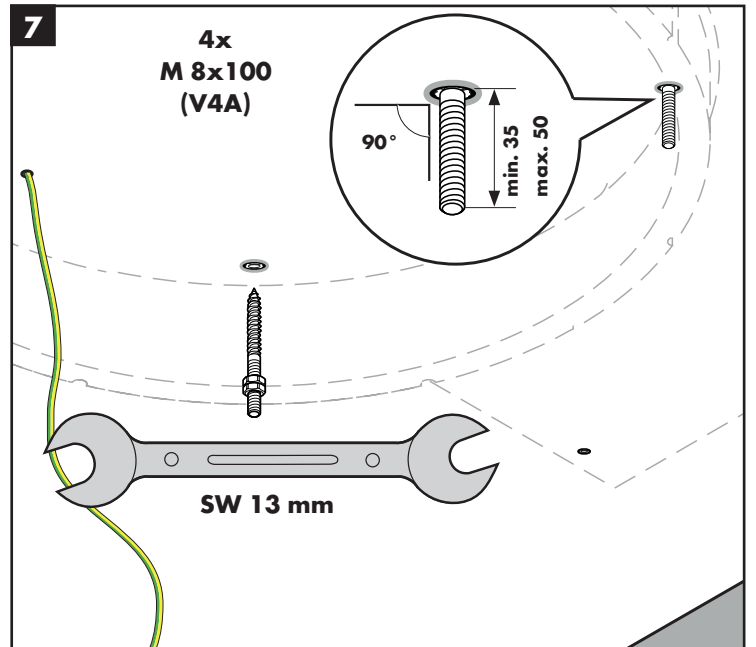
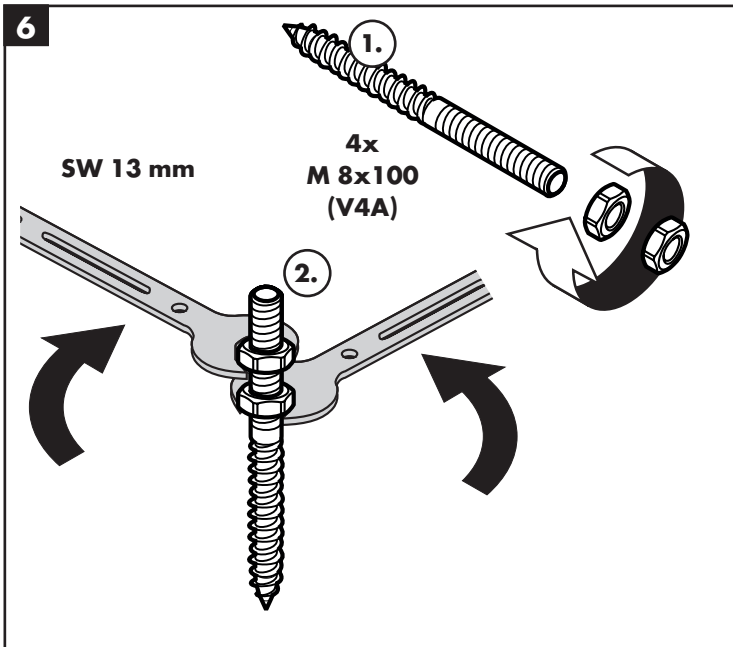
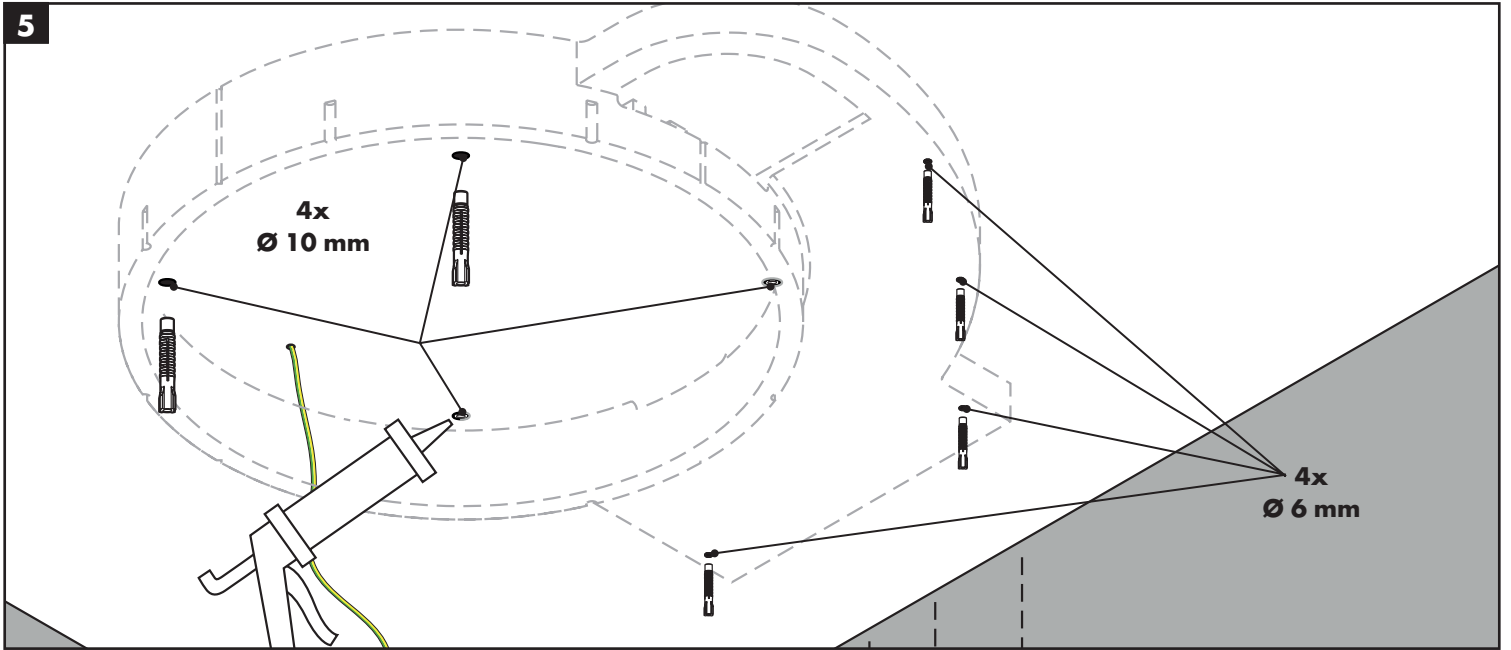

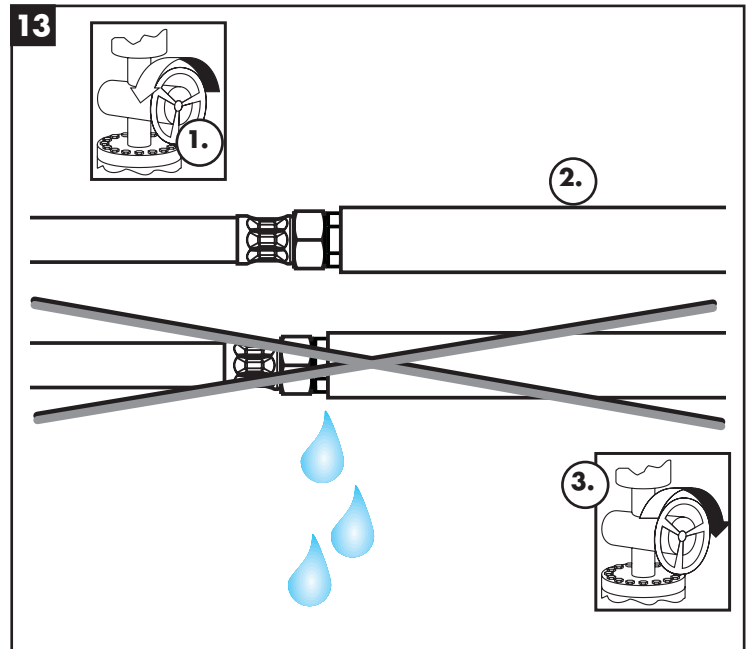
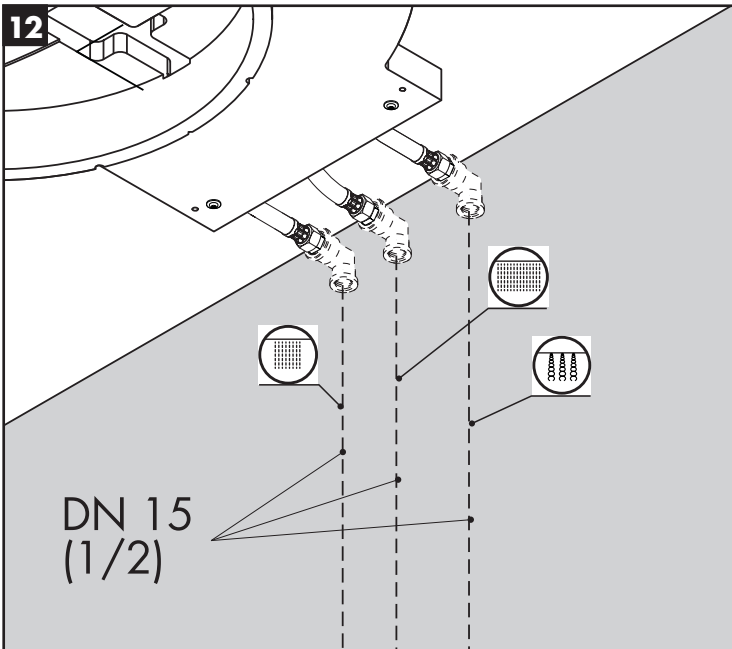
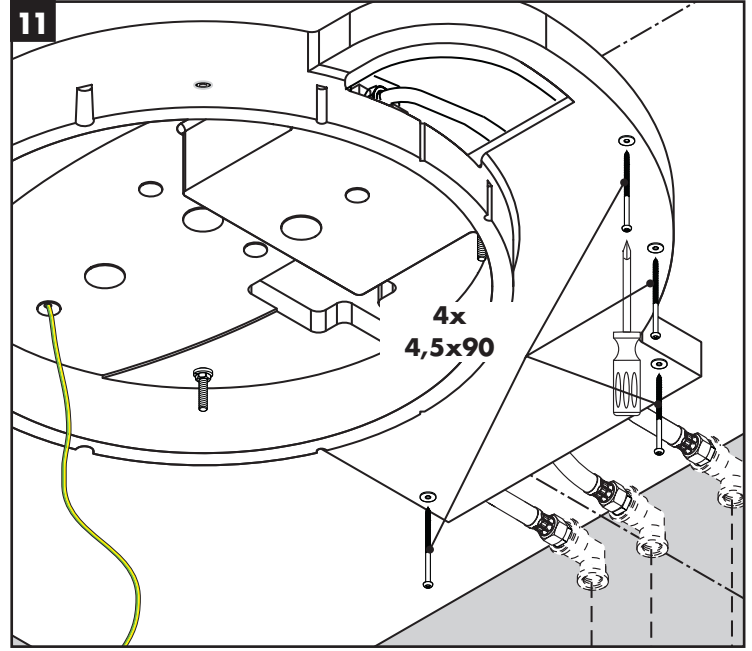
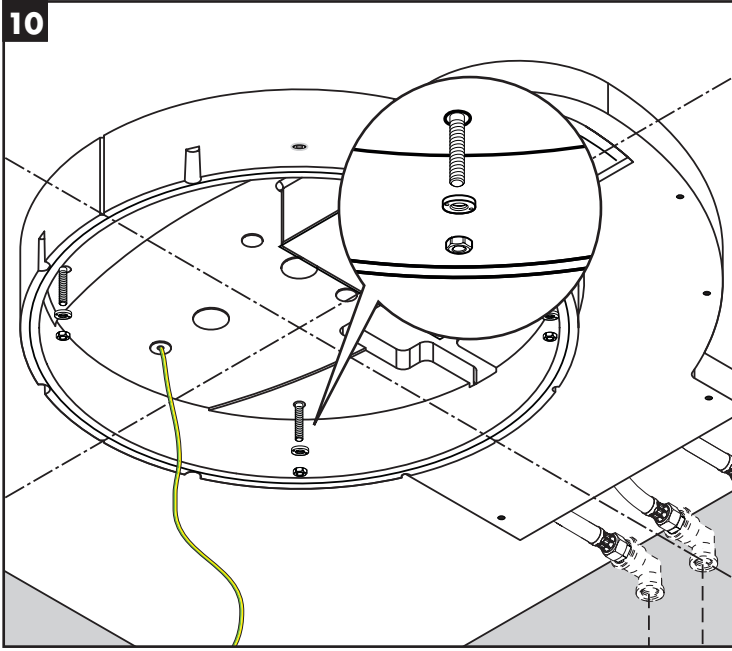

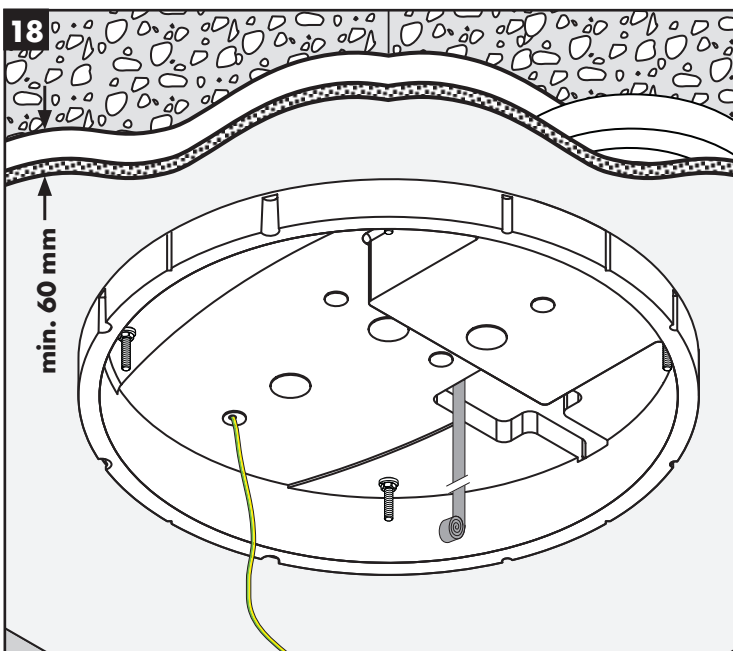
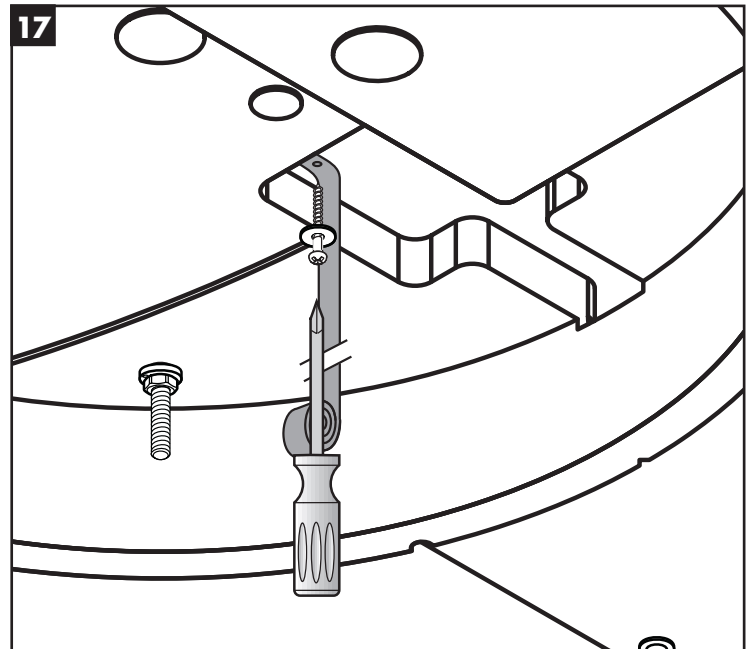
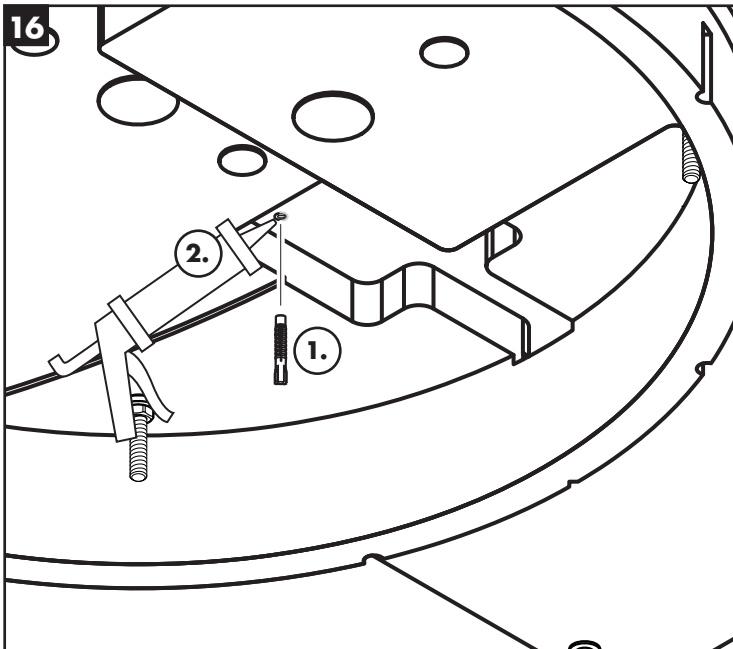
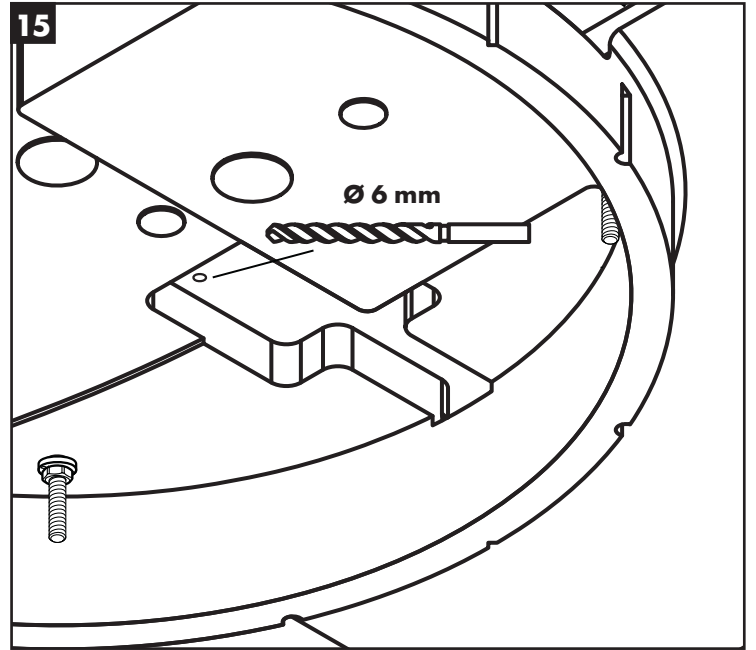
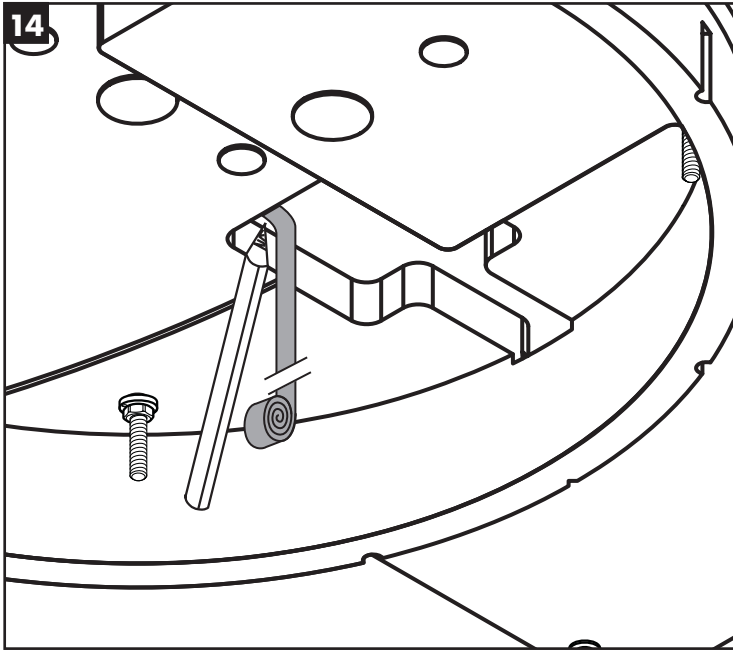

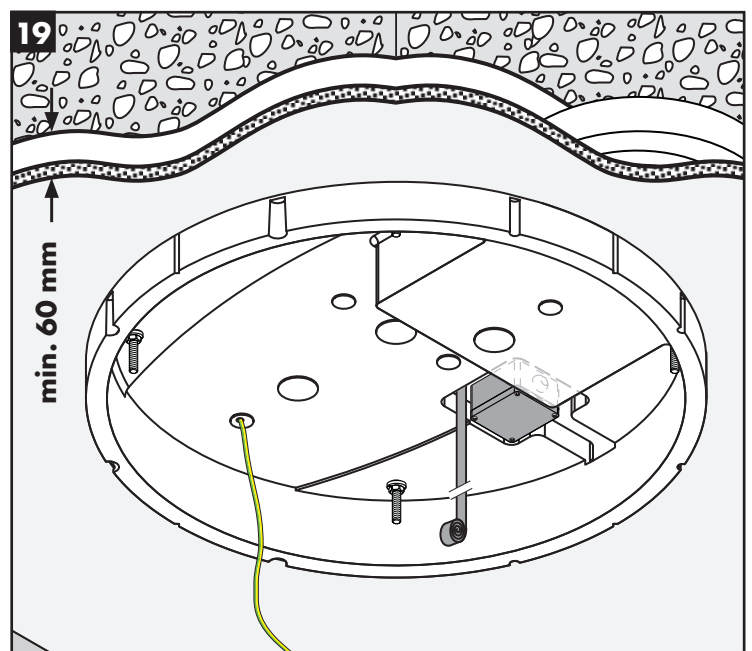
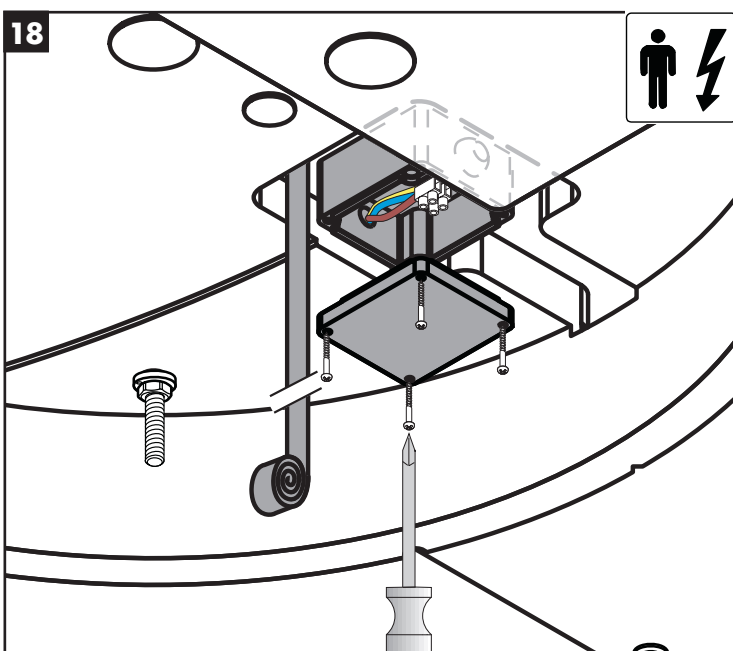
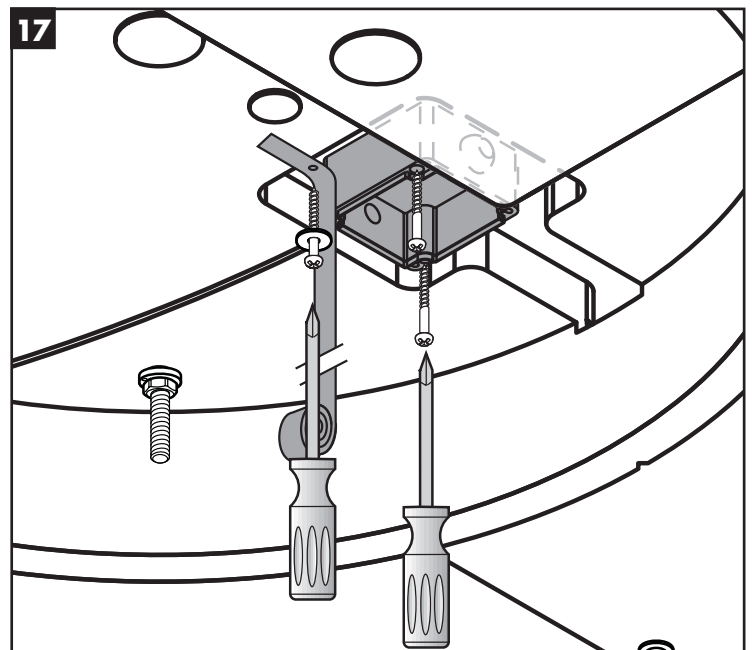
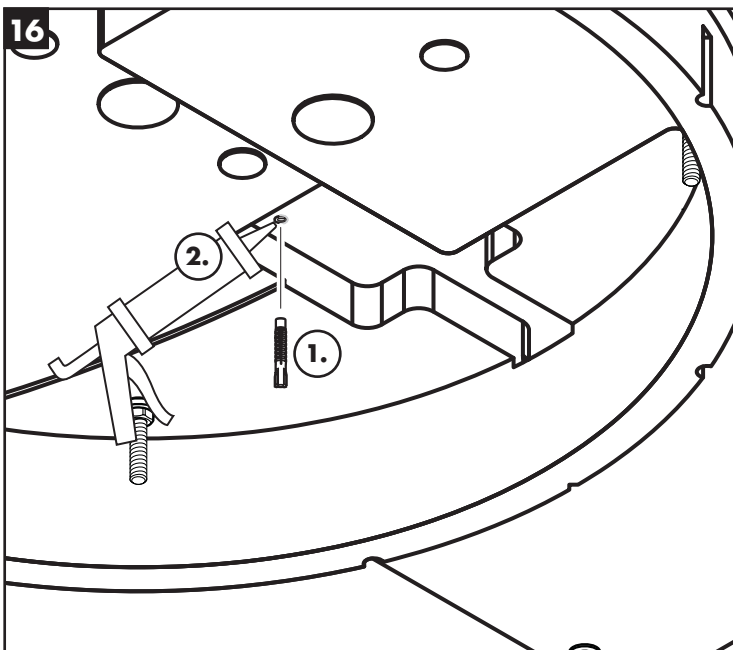
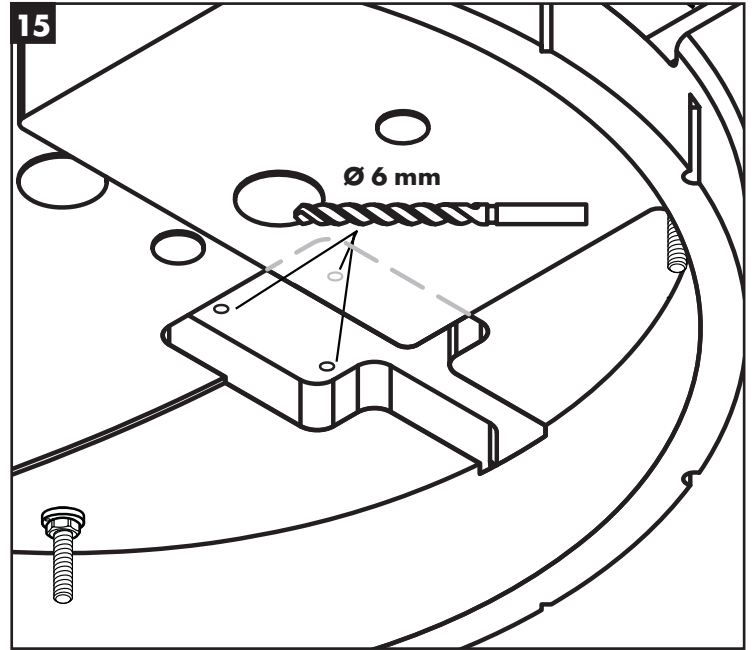
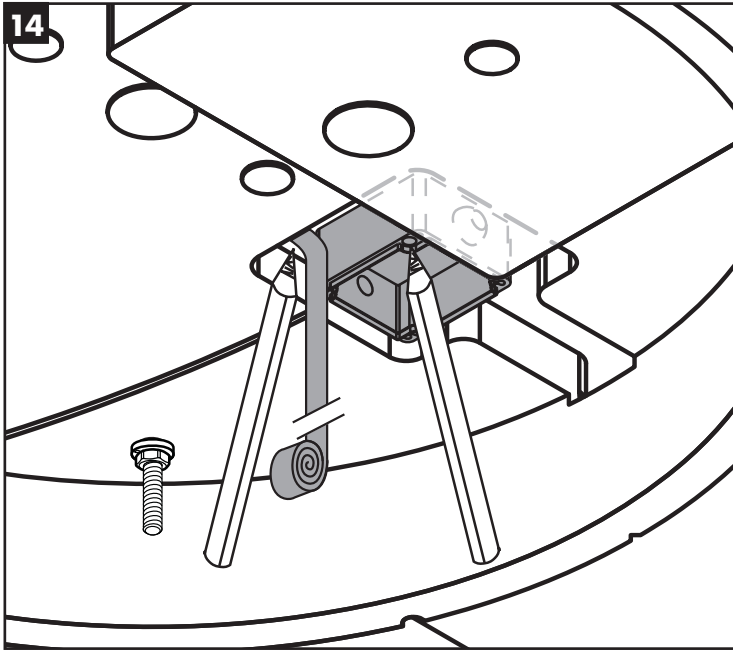

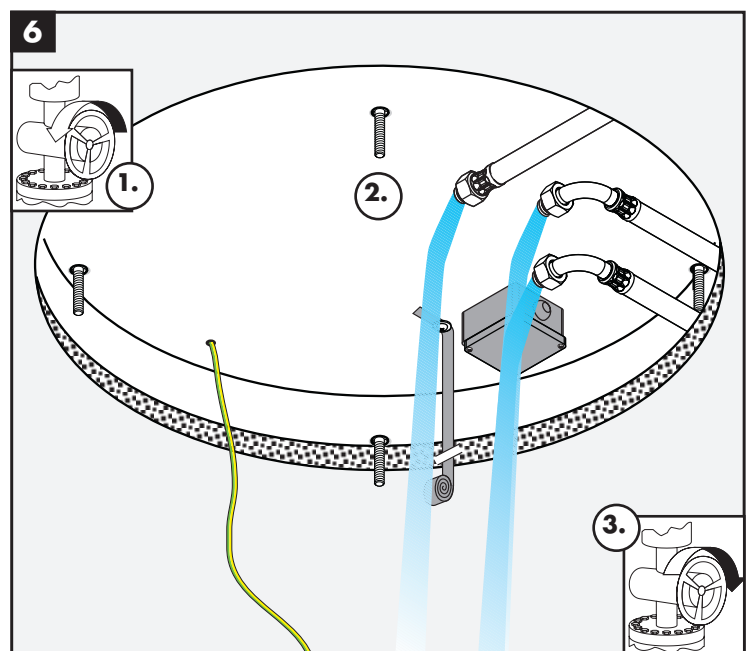
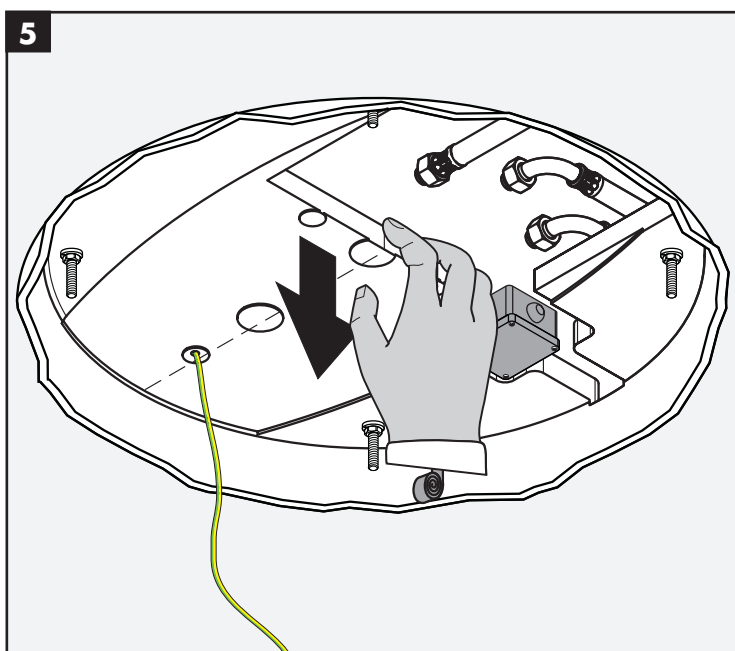
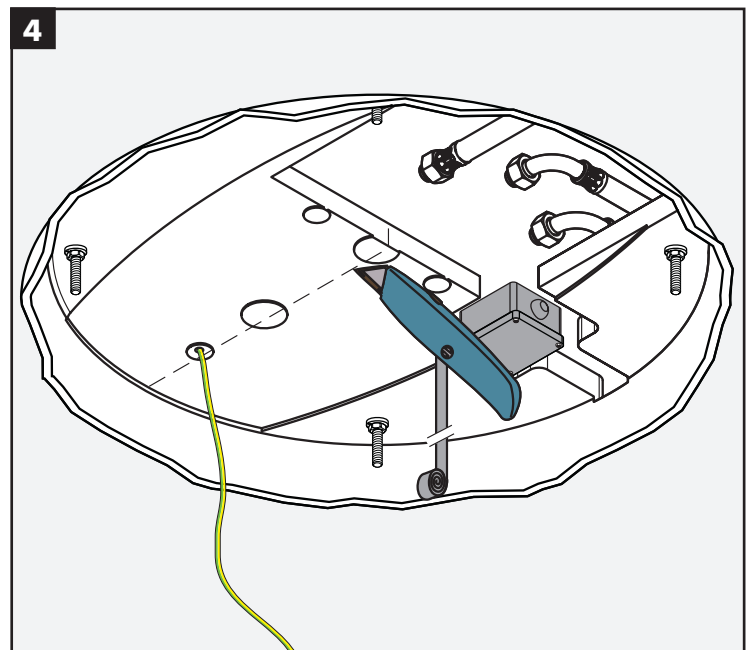
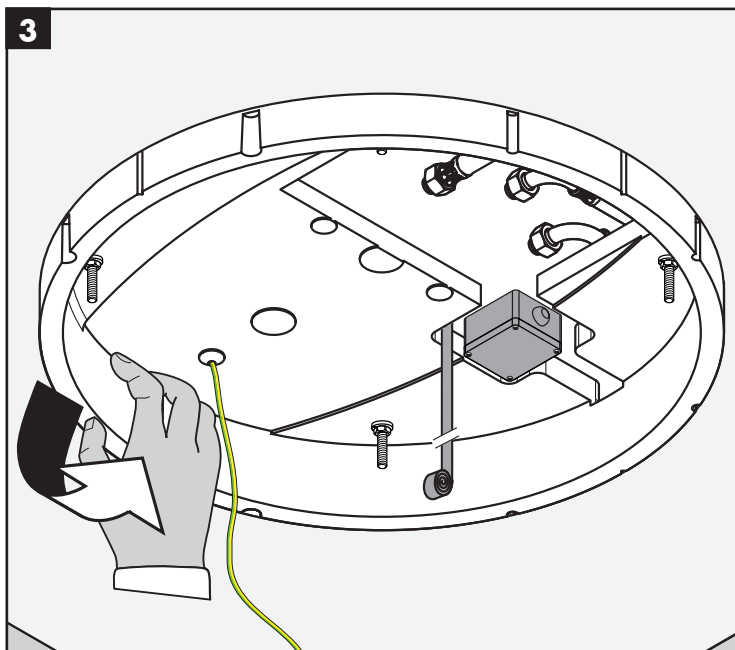
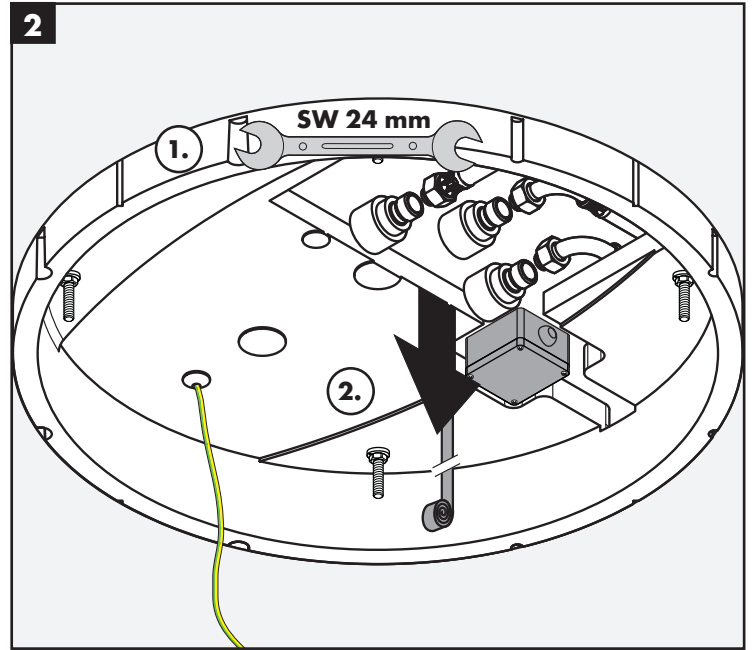
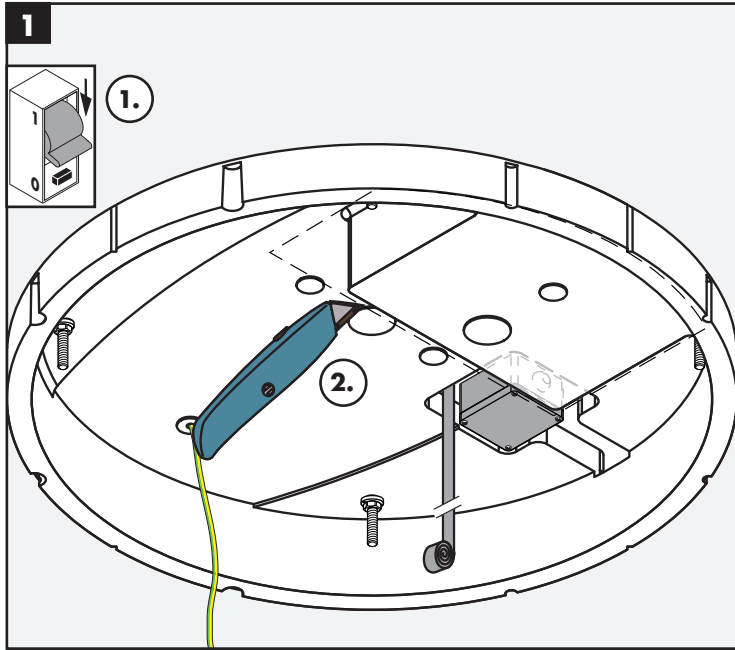
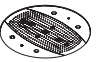

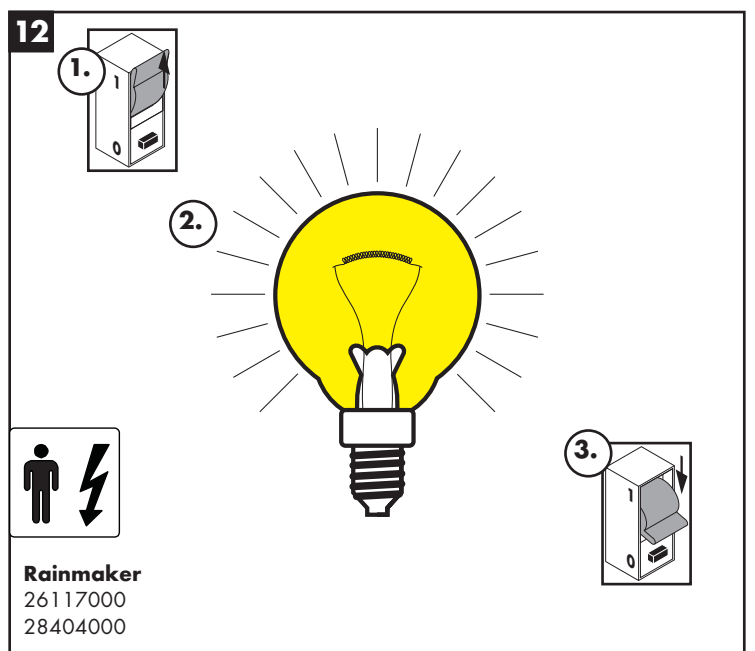
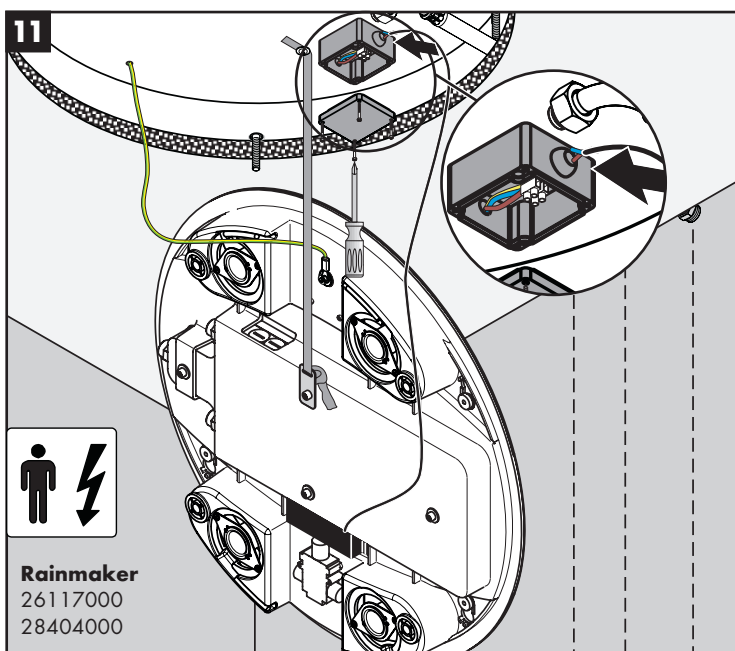
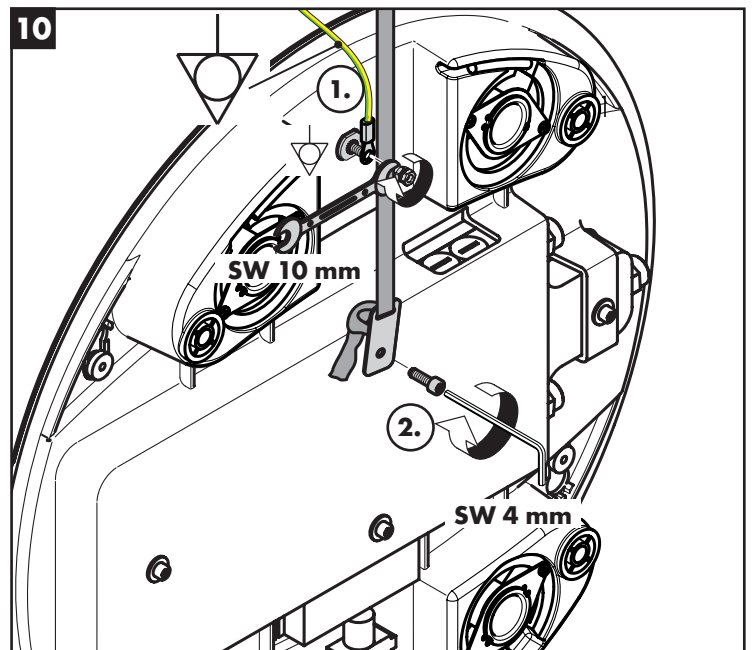
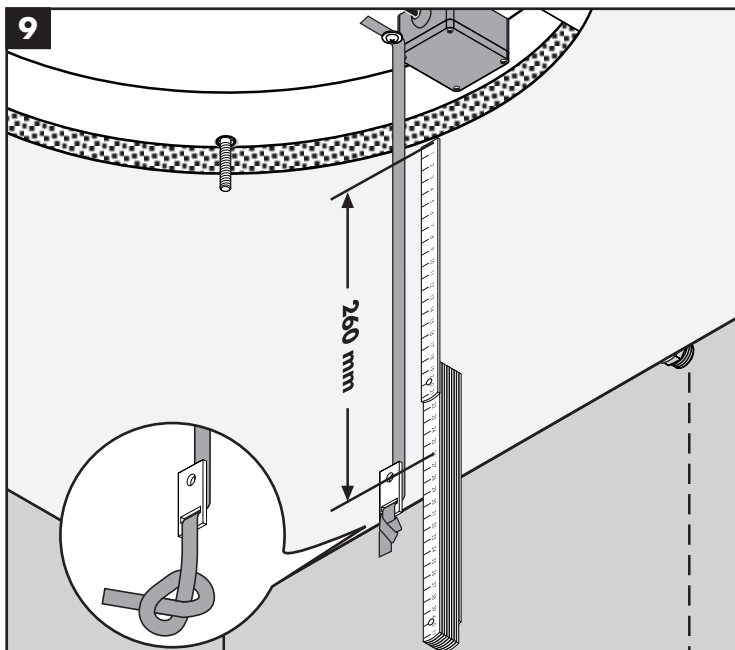
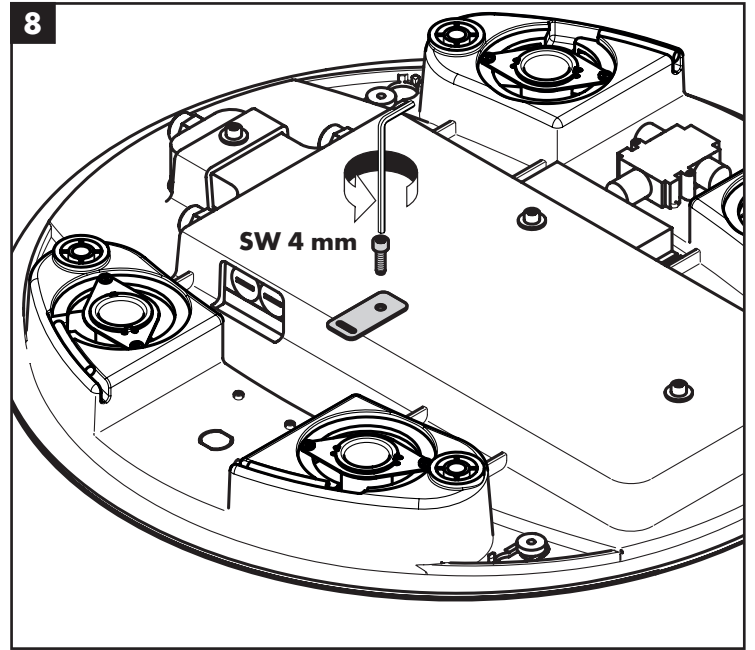
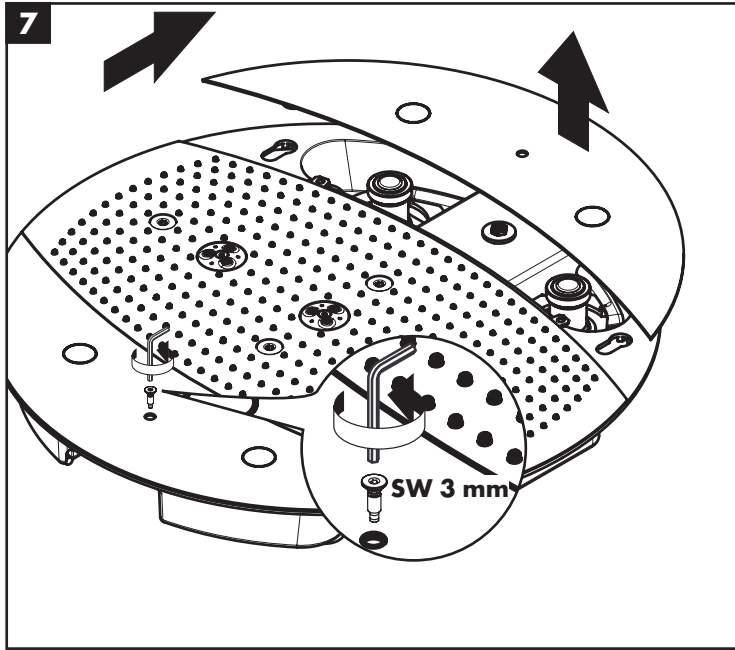
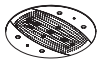

Rainmaker
26117000
28404000

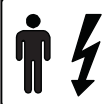

Rainmaker
26117000
28404000

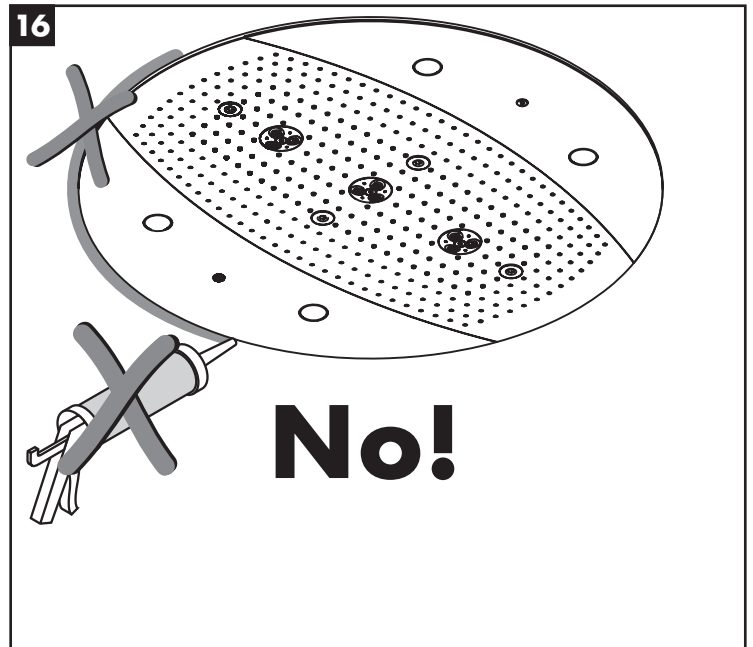
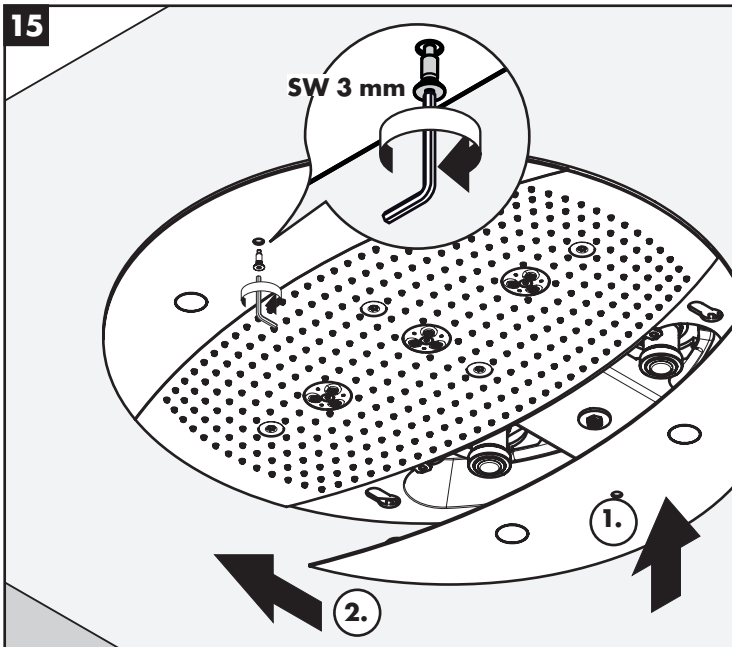
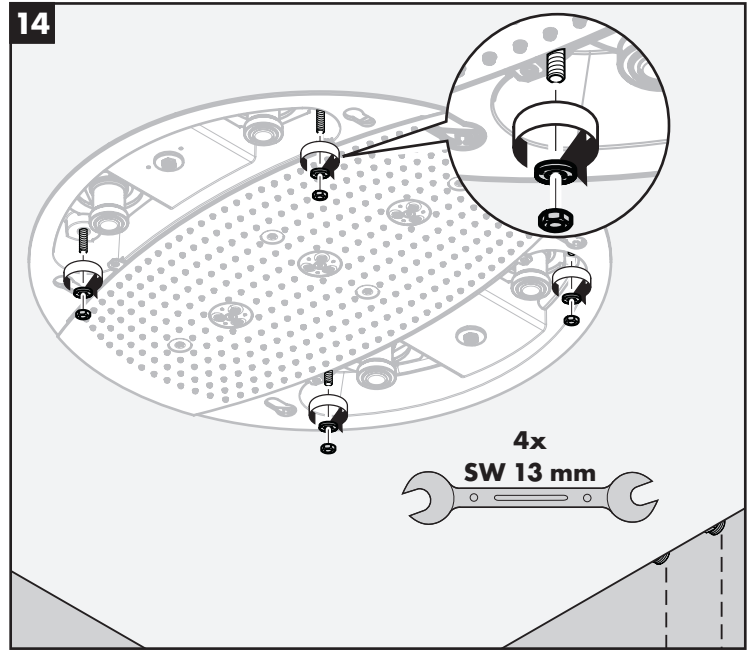
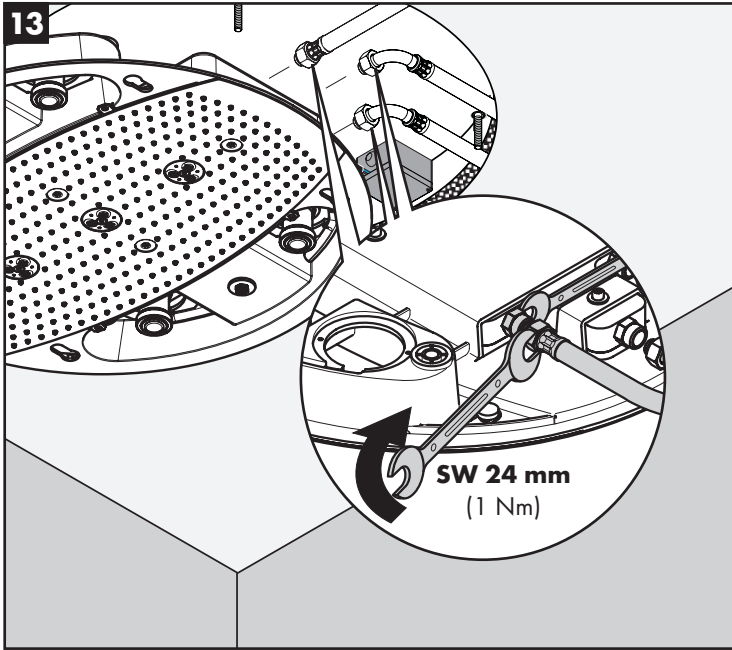
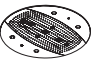

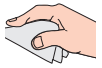

[www.hansgrohe.com/
cleaning-recommendation](http://www.hansgrohe.com/cleaning-recommendation)

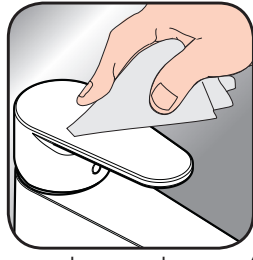

[www.hansgrohe.com/
cleaning-recommendation](http://www.hansgrohe.com/cleaning-recommendation)



[www.hansgrohe.com/
cleaning-recommendation](http://www.hansgrohe.com/cleaning-recommendation)



[www.hansgrohe.com/
cleaning-recommendation](http://www.hansgrohe.com/cleaning-recommendation)

- DE** Reinigungsempfehlung / Garantie / Kontakt
FR Recommandation pour le nettoyage / Garanties / Contact
EN Cleaning recommendation / Warranty / Contact
IT Raccomandazione di pulizia / Garanzia / Contatto
ES Recomendaciones para la limpieza / Garantía / Contacto
NL Aanbevelingen inzake reiniging / Garantie / Contact
DK Rensning, anbefaling / Garanti / Kontakt
PT Recomendações de limpeza / Garantia / Contacto
PL Zalecenie dotyczące pielęgnacji / Gwarancja / Kontakt
CS Doporučení k čištění / Záruka / Kontakt
SK Odporúčania pre čistenie / Záruka / Kontakt
ZH 清洁指南 / 担保 / 接触
RU Рекомендации по очистке / Гарантия / Контакты
HU Tisztítási tanácsok / Garancia / érintkezés
FI Puhdistussuositus / Takuu / Kosketus

- SV** Rengöringsrekommendationer / Garanti / Contacto
LT Valymo rekomendacijos / Garantija / Kontaktai
HR Preporuke za čišćenje / Garancija / Kontakt
TR Temizleme önerisi / Garanti / Temas
RO Recomandări pentru curățare / Garanție / Contact
EL Σύσταση καθαρισμού / Εγγύηση / επαφή
SL Priporočilo za čiščenje / Garancija / Kontakt
ET Puhastussuovitused / Garantii / Kontakt
LV Tīrīšanas ieteikumi / Garantija / Kontakti
SR Preporuke za čišćenje / Garancija / Kontakt
NO Anbefaling for rengjøring / Garanti / Kontakt
BG Препоръка за почистване / Гаранция / Контакт
SQ Këshilla rreth pastrimit / Garancia / Kontakt
KO 세정시 권장사항 / 품질보증 / 접촉
AR توصيات التنظيف / الضمان (الولايات المتحدة الأمريكية) / اتصال

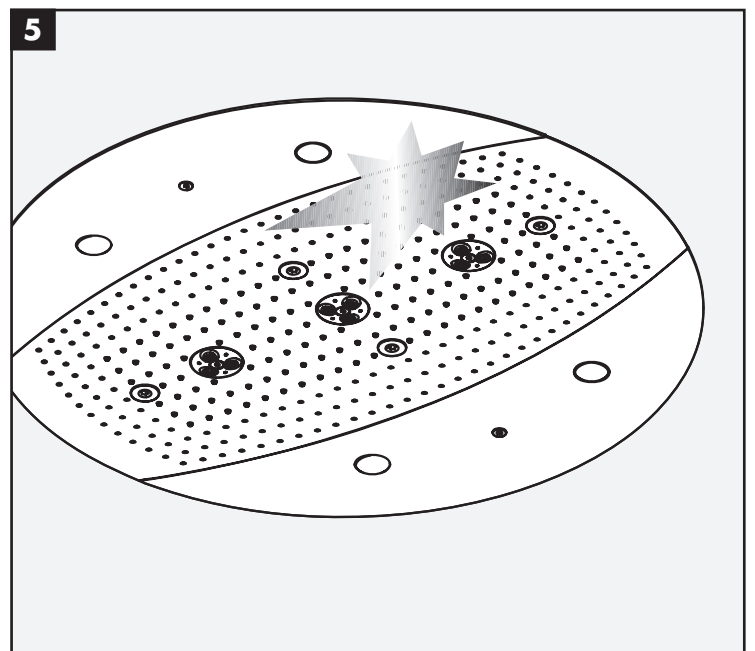
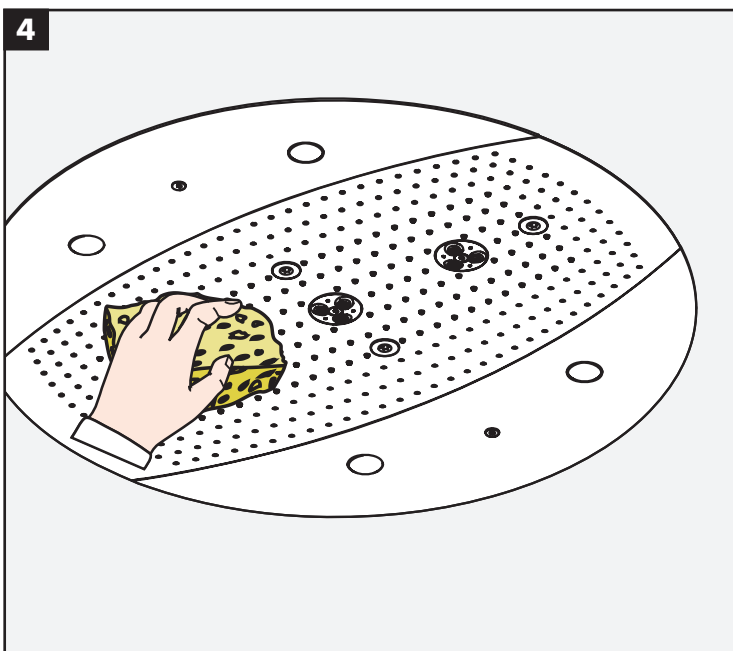
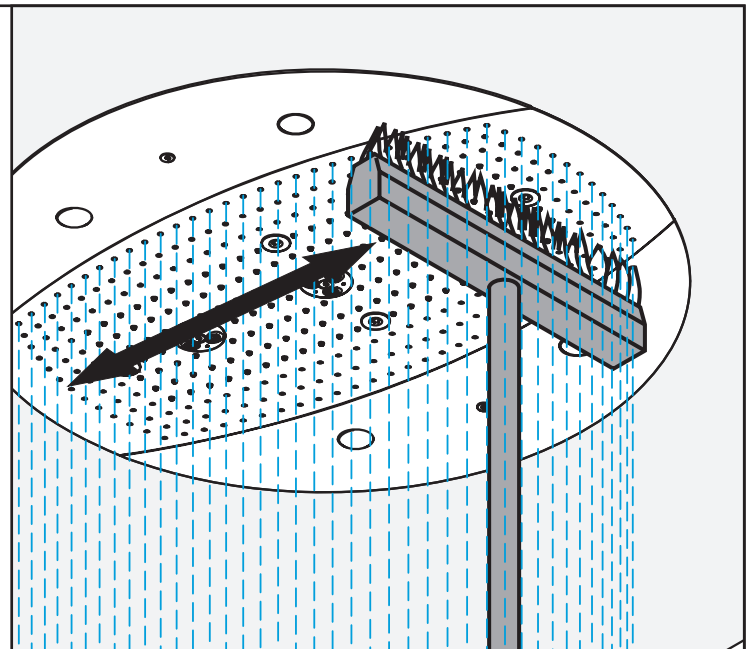
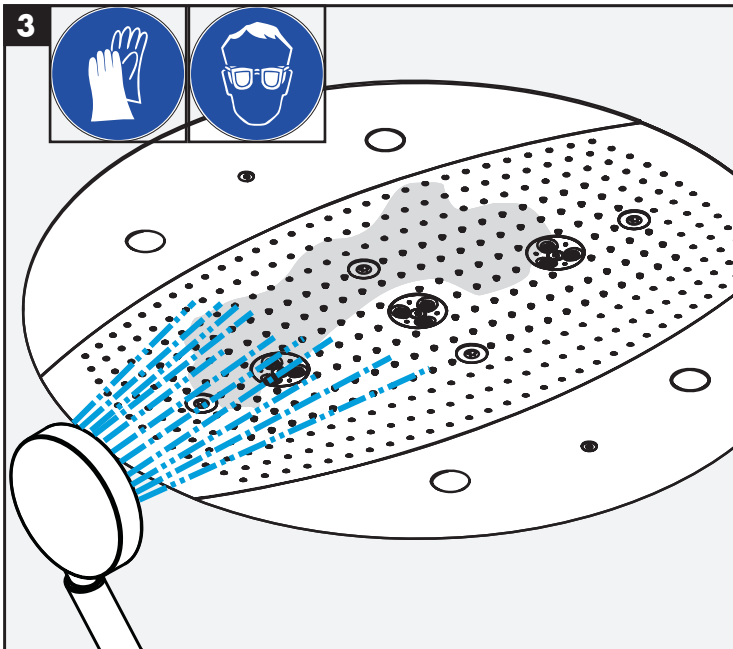
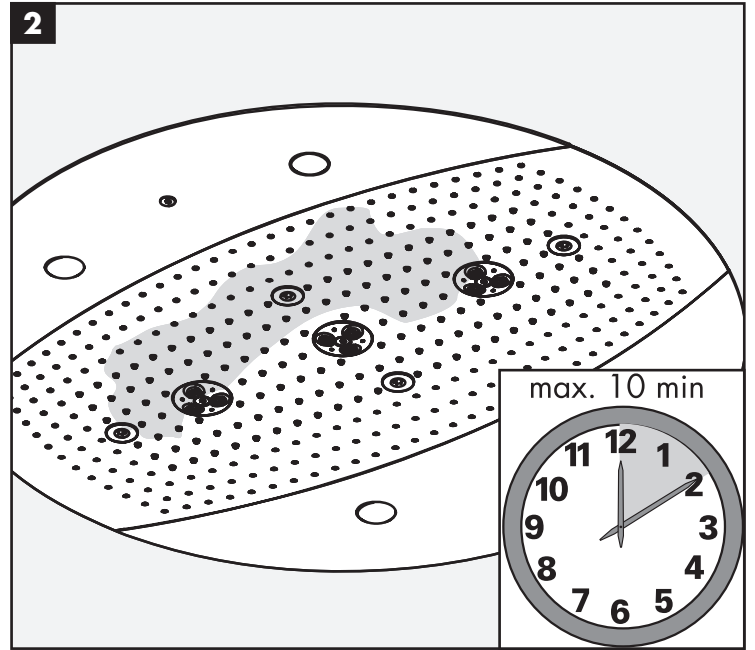
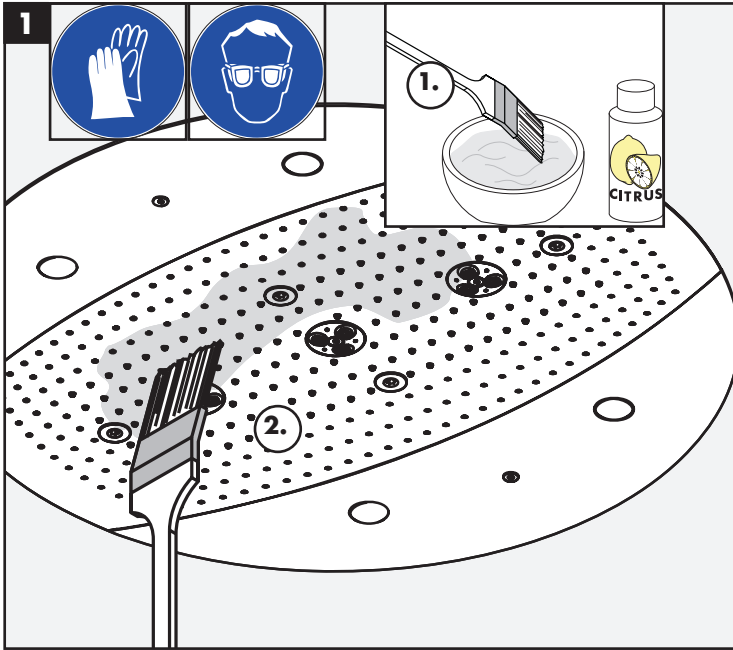

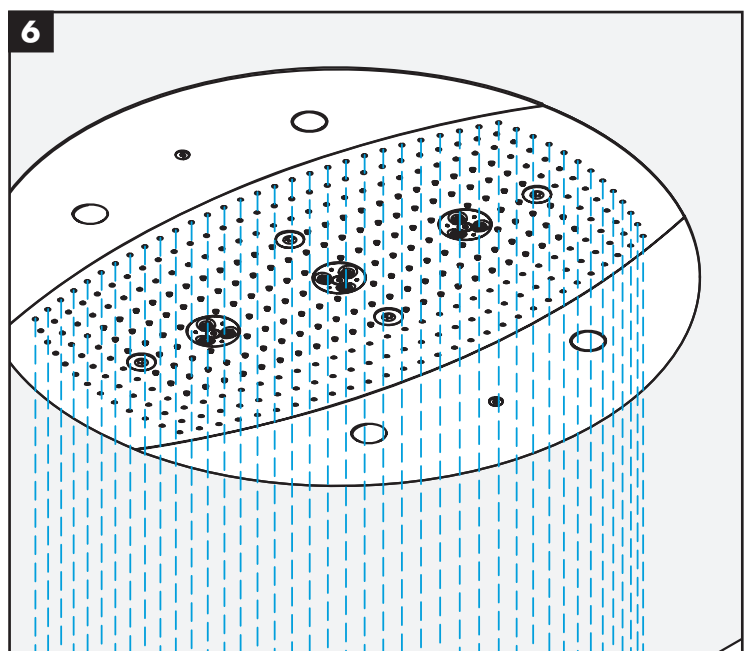
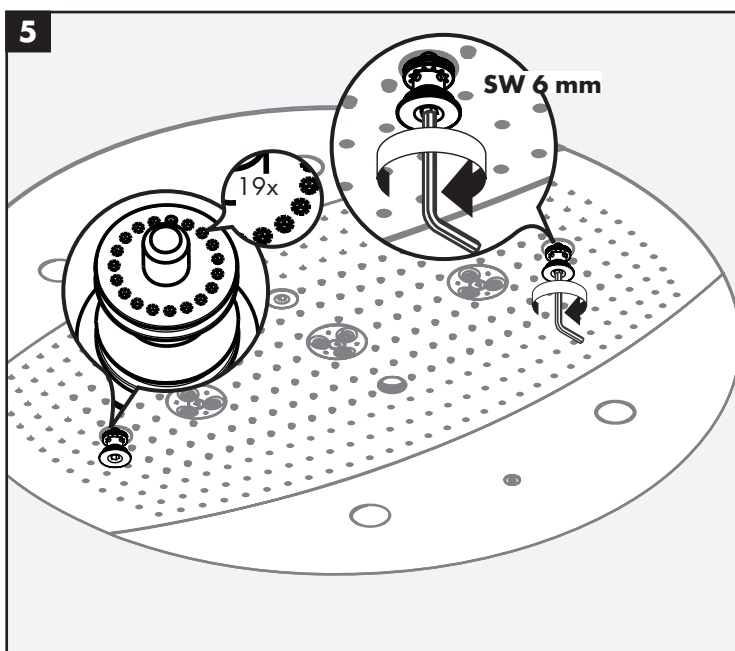
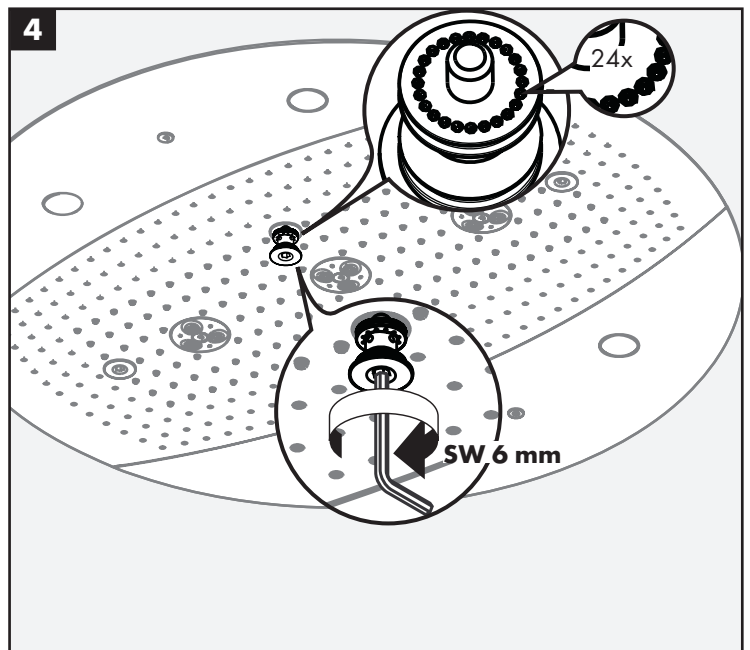
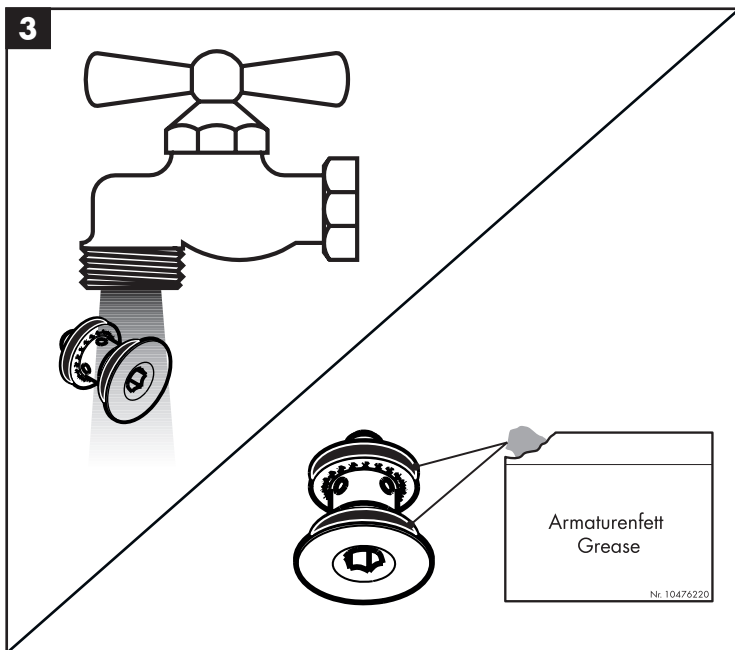
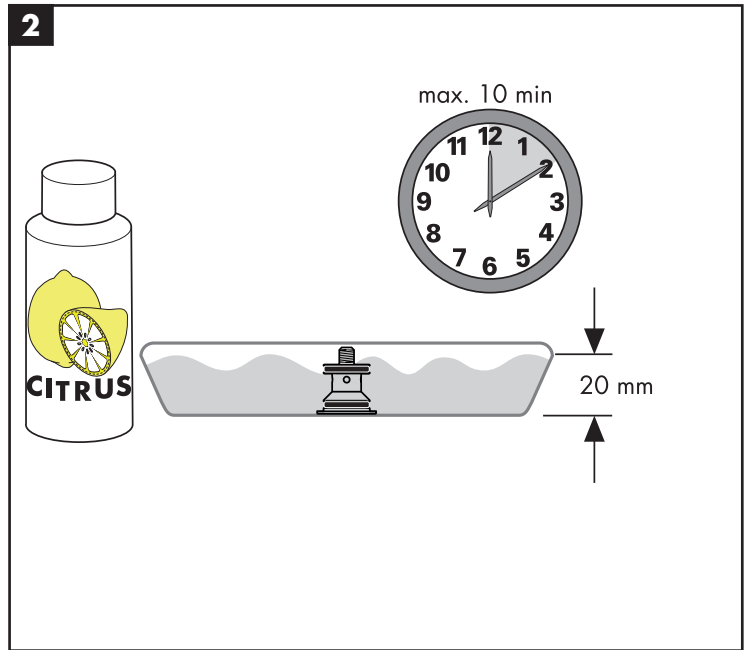
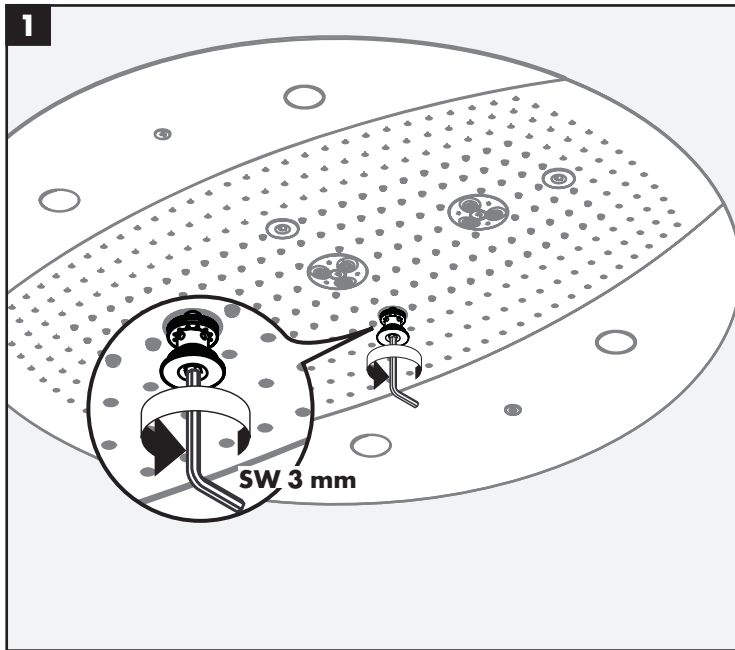

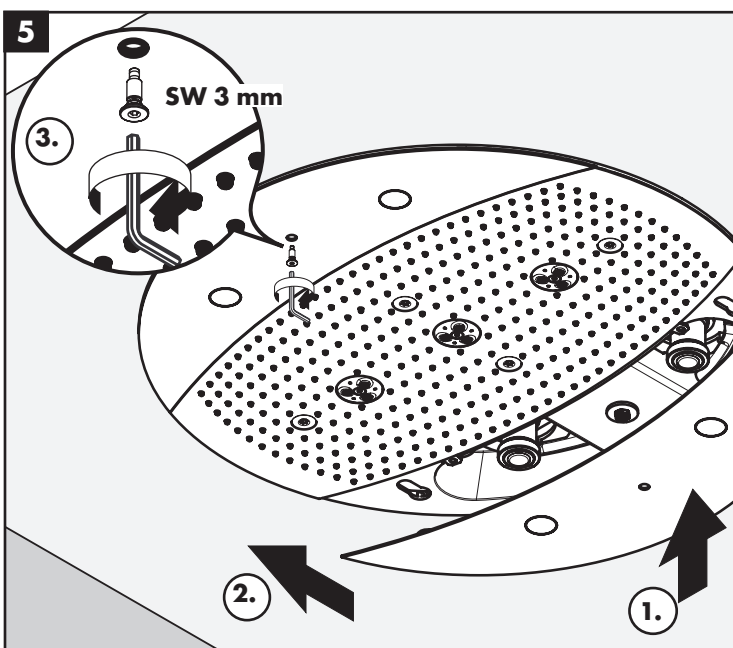
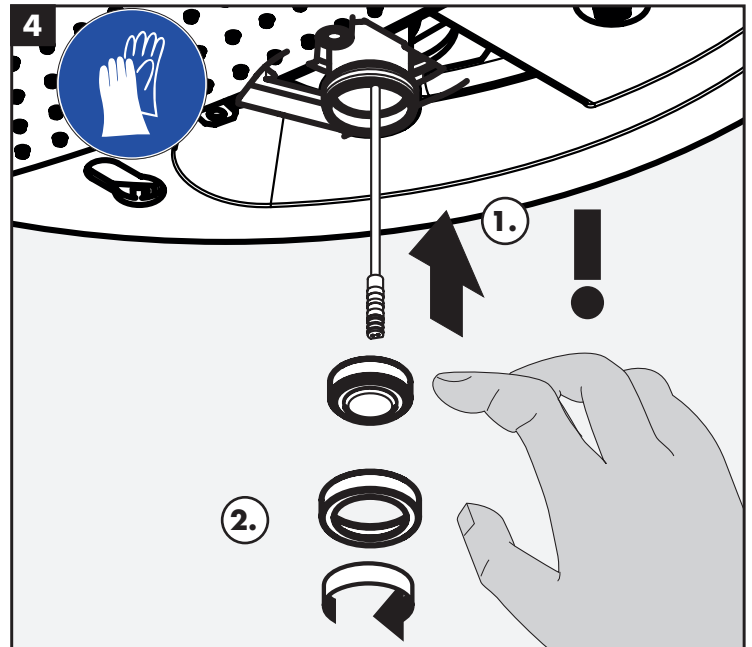
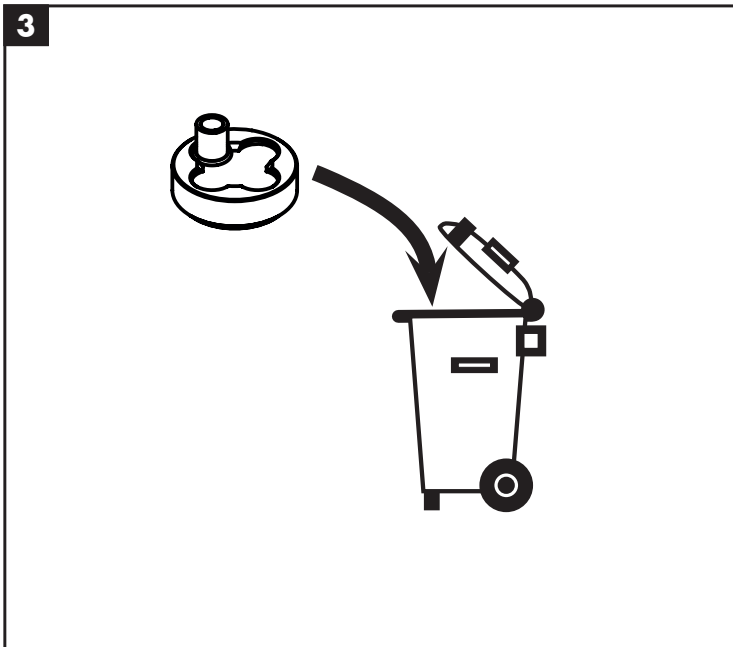
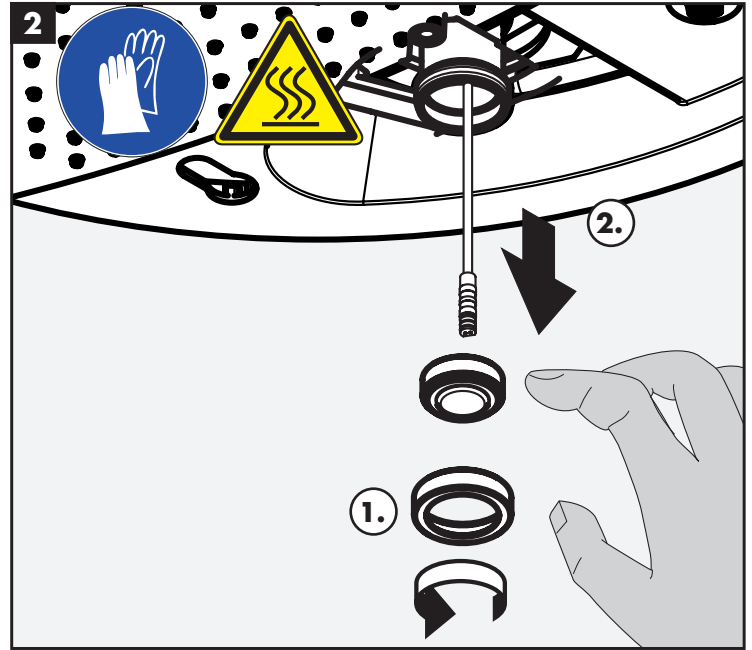
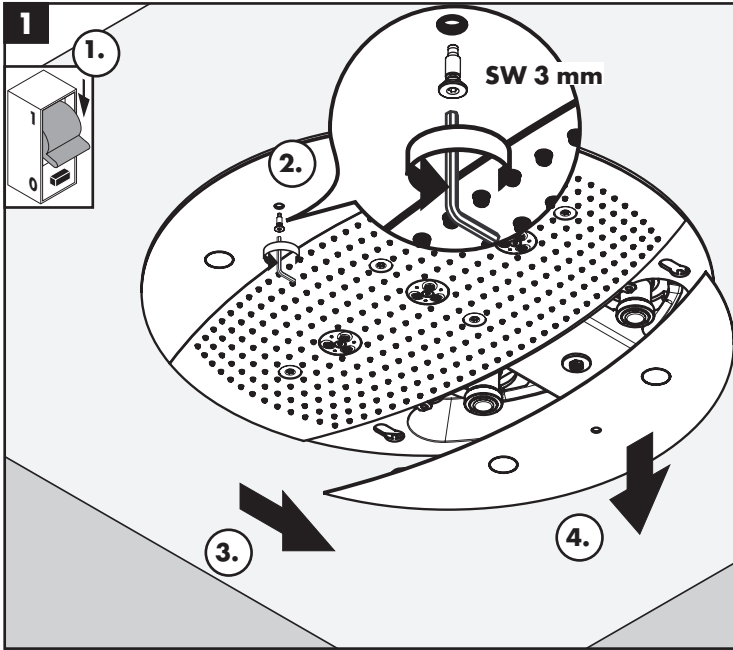

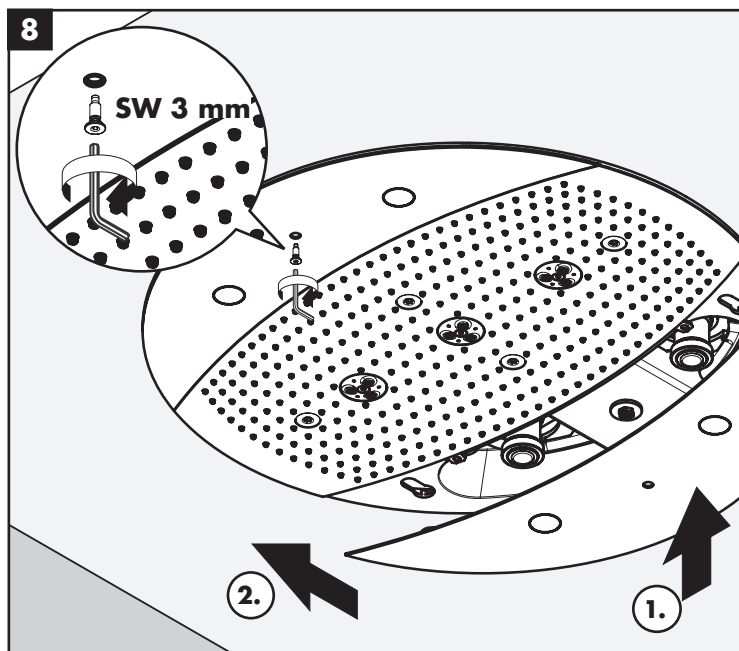
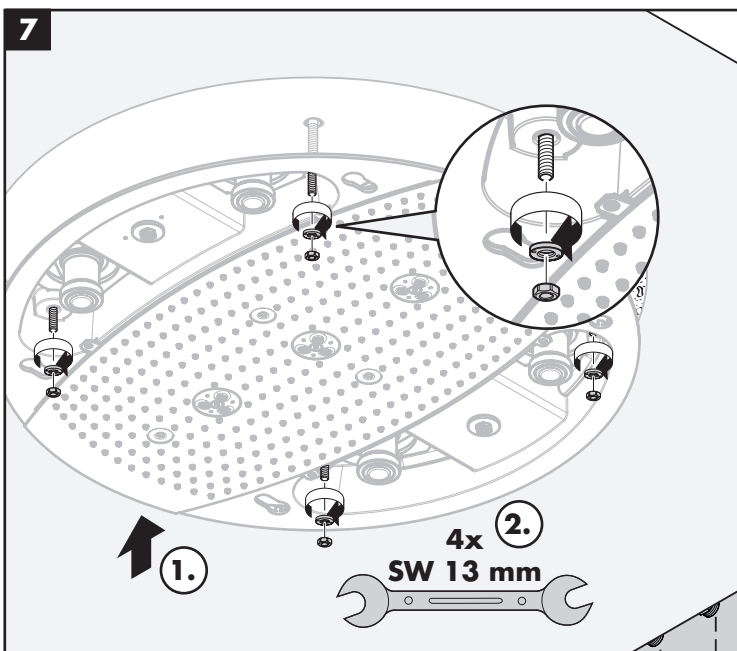
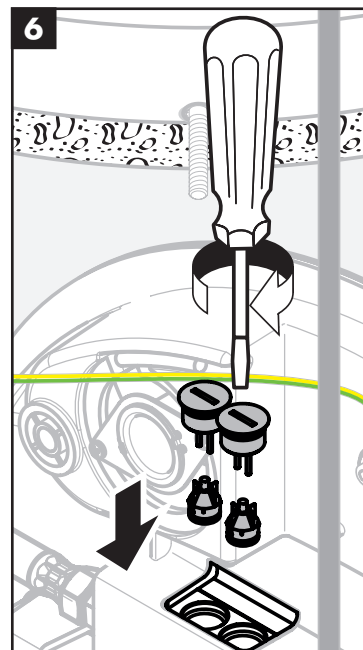
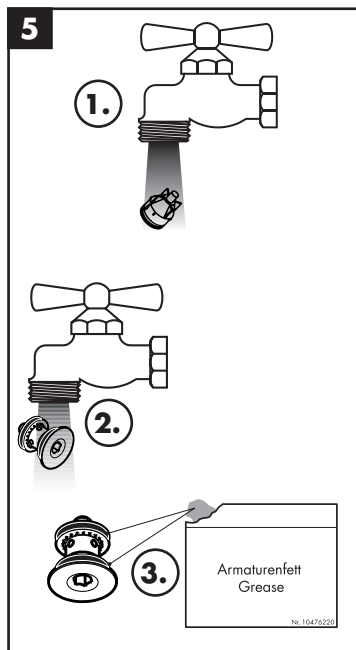
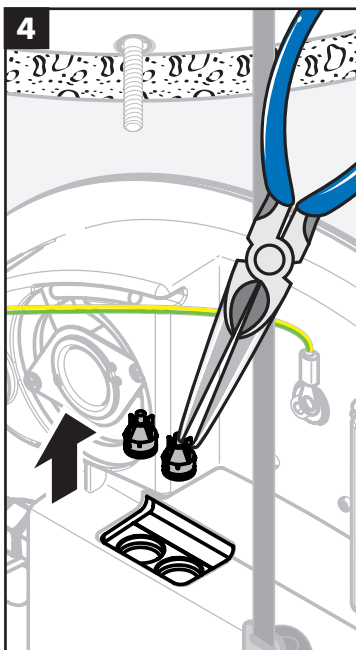
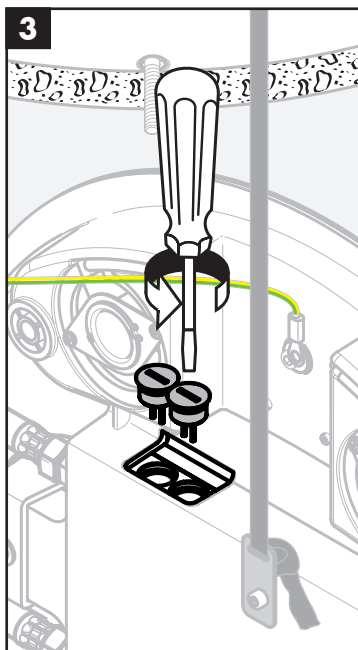
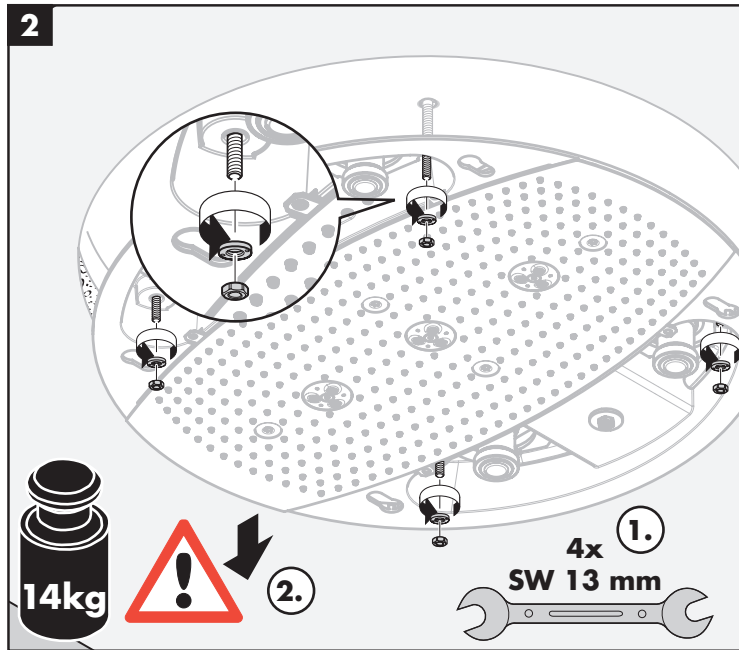
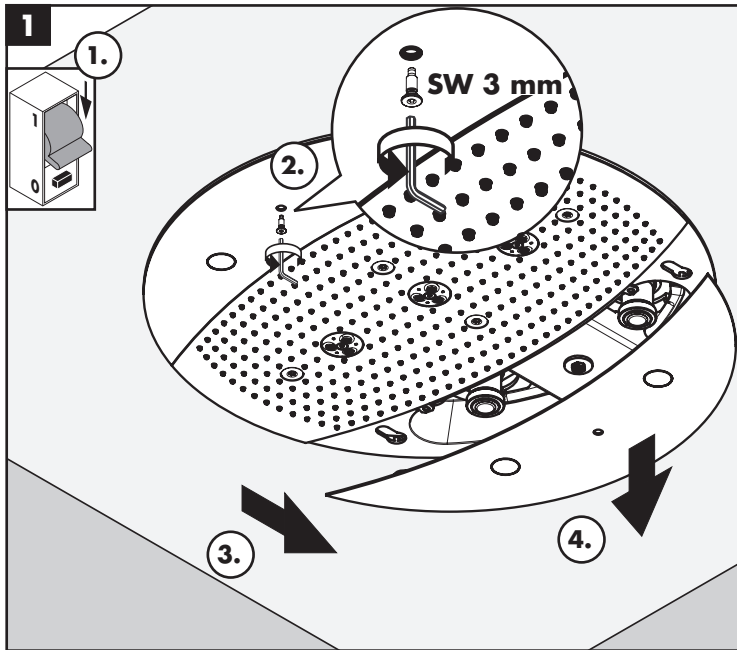





P-IX	DVGW	SVGW	ACS	WRAS	ETA
26115000		X			
26117000		X			
28403000		X			
28404000		X			
28412180		X			

hansgrohe
26117000, 28404000

 Diese Leuchte ist geeignet für Leuchtmittel der



Diese Leuchte wird verkauft mit einem Leuchtmittel der Energieklasse: 

874/2012 

- FR** Ce luminaire est compatible avec des ampoules des classes énergétiques: A+
Le luminaire est vendu avec une ampoule de la classe énergétique: A+
- EN** This light fitting is compatible with bulbs from energy classes: A+
The light fitting is sold with a bulb from energy class: A+
- IT** Questo dispositivo è compatibile con lampadine di classi energetiche: A+
Il dispositivo è venduto con una lampadina di classe energetica: A+
- ES** Esta luminaria es compatible con bombillas de las clases energéticas: A+
Esta luminaria se vende con una bombilla de la clase energética: A+
- NL** In deze armatuur passen lampen met energieklassen: A+
De armatuur wordt verkocht met een lamp met energieklassen: A+
- DK** I denne lampe kan anvendes pærer i energiklasse: A+
Denne lampe sælges med en pære i energiklasse: A+
- PT** Candeeiro compatível com lâmpadas das classes energéticas: A+
Inclui uma lâmpada da classe energética: A+
- PL** Oprawa jest przystosowana do żarówek o klasach energetycznych: A+
Oprawę sprzedaje się z żarówką o klasie energetycznej: A+
- CS** Toto svítidlo je kompatibilní se žárovkami energetických tříd: A+
Toto svítidlo se prodává se žárovkou energetické třídy: A+
- SK** Toto svetidlo je kompatibilné so žiarovkami energetických tried: A+
Toto svetidlo sa predáva so žiarovkou energetickej triedy: A+
- HU** A lámpatest a következő energiaosztályú égőekkel működik: A+
A lámpatesttel együtt eladott égő energiaosztálya: A+

- FI** Valaisimessa voidaan käyttää seuraaviin energialuokkiin kuuluvia lampuja: A+
Valaisimen mukana toimitettavan lampun energialuokka: A+
- SV** I denna ljusarmatur kan lampor av följande energiklasser användas: A+
Denna ljusarmatur säljs med en lampa i energiklass: A+
- LT** Šviestuvą galima naudoti su šiuo energijos klasių lemputėmis: A+
Šviestuvą parduodamas su lempute, kurios energijos klasė yra: A+
- HR** Ovo rasvjetno tijelo kompatibilno je sa žaruljama ovog energetskog razreda: A+
Rasvjetno tijelo se prodaje sa žaruljama ovog energetskog razreda: A+
- RO** Acest corp de iluminat este compatibil cu becurile din clasele energetice: A+
Acest corp de iluminat este vândut cu un bec din clasa energetică: A+
- EL** Το Φωτιστικό αυτό είναι συμβατό με λαμπτήρες ενεργειακής τάξης: A+
Το Φωτιστικό αυτό πωλείται με λαμπτήρα ενεργειακής τάξης: A+
- SL** Ta svetilka je združljiva s sijalkami naslednjih energijskih razredov: A+
Ta svetilka se prodaja s sijalko energijskega razreda: A+
- ET** Sellesse valgustisse saab panna järgmiste energiklasside lampe: A+
Seda valgustit müüakse koos lambiga, mille energiklass on: A+
- LV** Šis gaismeklis ir saderīgs ar šādu energoefektivitātes klašu spuldzēm: A+
Šo gaismekli pārdod ar šādas energoefektivitātes klases spuldzi: A+
- BG** това осветително тяло е съвместимо с крушките от енергийни класове: A+
това осветително тяло се продава с крушка от енергиен клас: A+