

CLASSICS

Washbasin bowl, glazed steel, with tap bank, with one tap hole, centered, with overflow, including fixing set, overflow set



DIMENSIONS

Length	585 mm
Width	405 mm
Height	135 mm

COLOUR AND FINISH

<input type="checkbox"/>	000 White
--------------------------	-----------

OPTIONS

104 - one tap hole, centre

Back glazed

Bowl length (mm) : 585

Bowl position : Central

Bowl width (mm) : 405

Fixing kit : Included

Glazed base

Installation type : Bowl / On countertop

Internal Shape : 6 - Rectangular

Material : Glazed steel

Net weight (kg) : 5.7

Overflow type : Standard

Plug and Waste : Not included

Shape : Rectangular

Taphole configuration : 1 taphole in the middle

Trap : Not included

Waste : Not included

Weight (Kg) : 5.7

TECHNICAL DRAWINGS

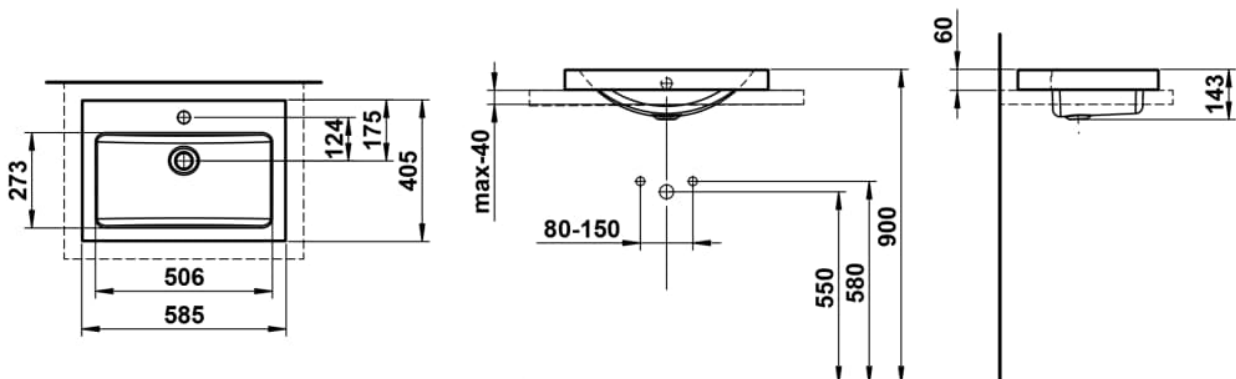

CLASSICS

The washbasins of the CLASSICS series combine iconic design with an emotional depth that shapes the space—clear, authentic, unmistakable. Every detail reflects a clear design intention: restrained, yet full of character.

Reduced depths, precisely defined geometries, and finely proportioned basins made of glazed steel create a sense of visual calm—even in compact spaces. These washbasins integrate seamlessly into smaller layouts, contributing to the order and clarity of the overall architectural concept.

Designed for those who seek the extraordinary in everyday life—and who want their bathroom to make a personal statement.