

Side view

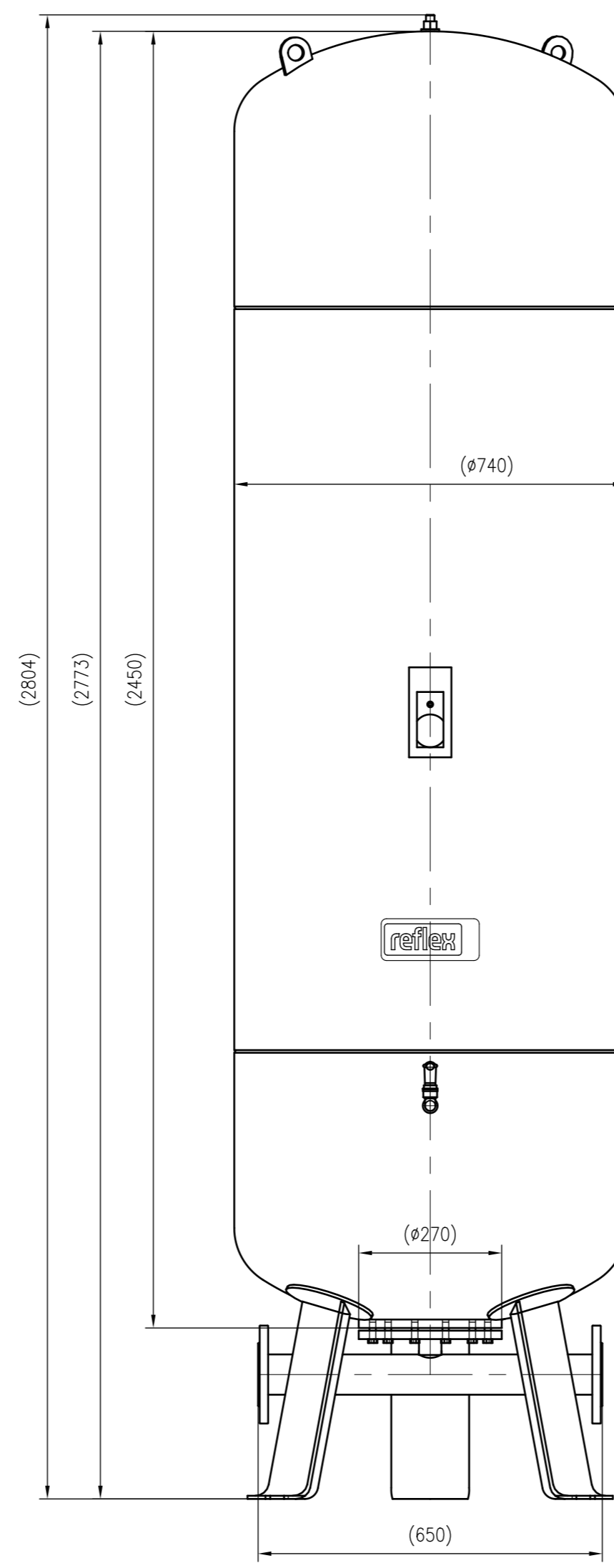

Front view

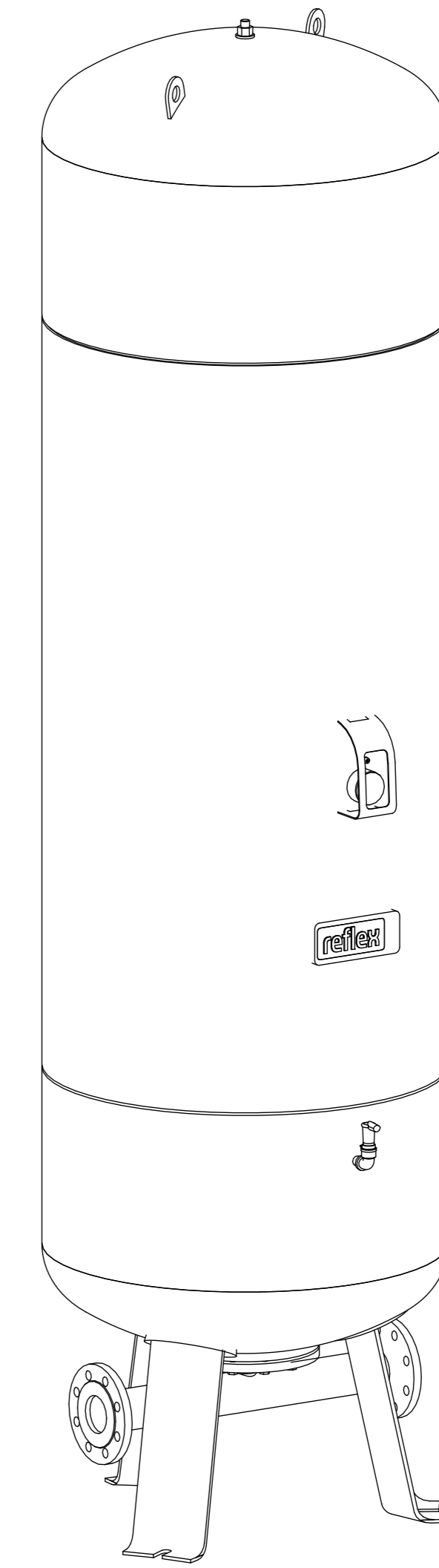

Isometric view

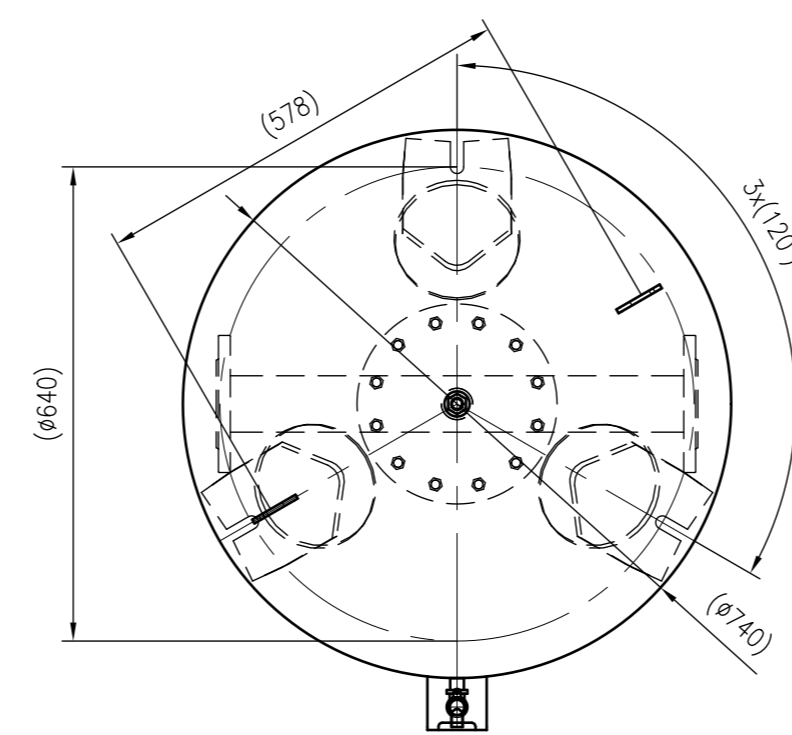

Top view



Unterliegt nicht dem Änderungsdienst/ Not subject to change management		Maßstab/ Scale: 1:10	Format/ Size: A1
Revision 19.12.2016	Reflex DT 1000 (740mm) 16bar – 7339505		
			A1