

Side view

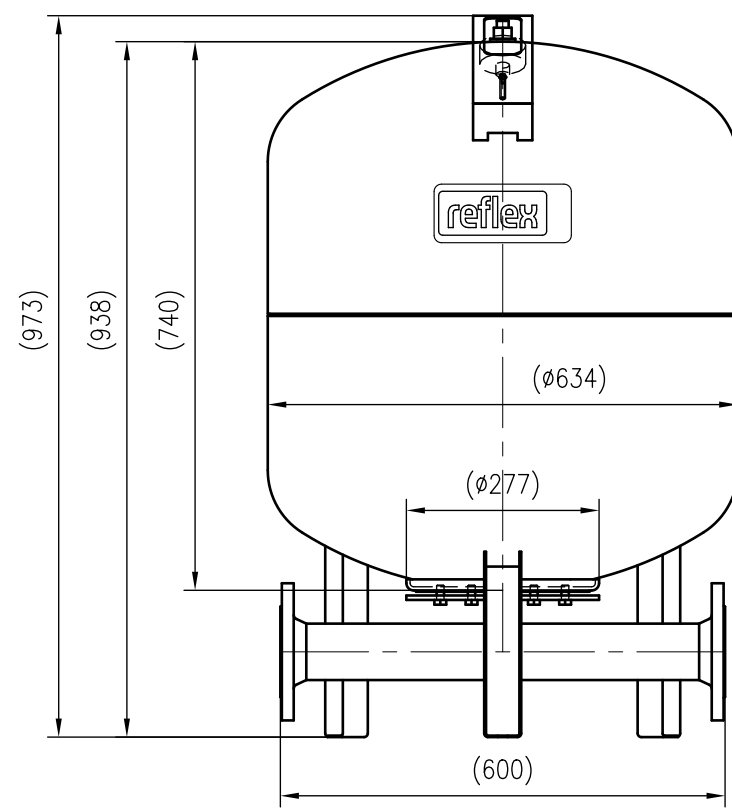

Front view

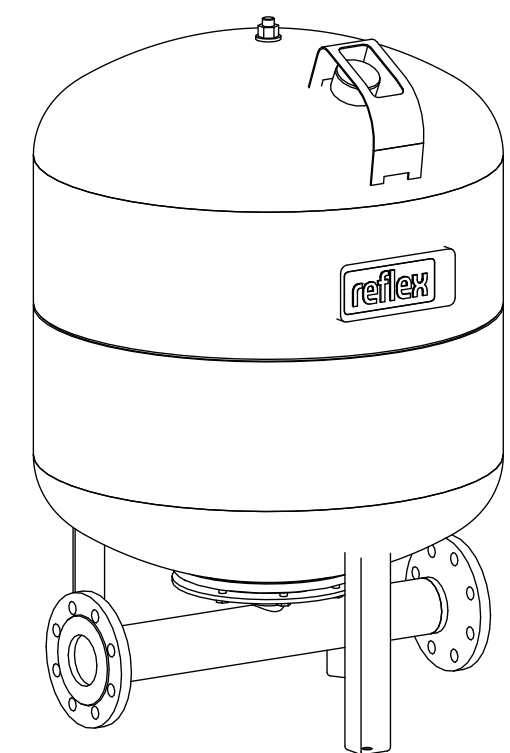

Isometric view

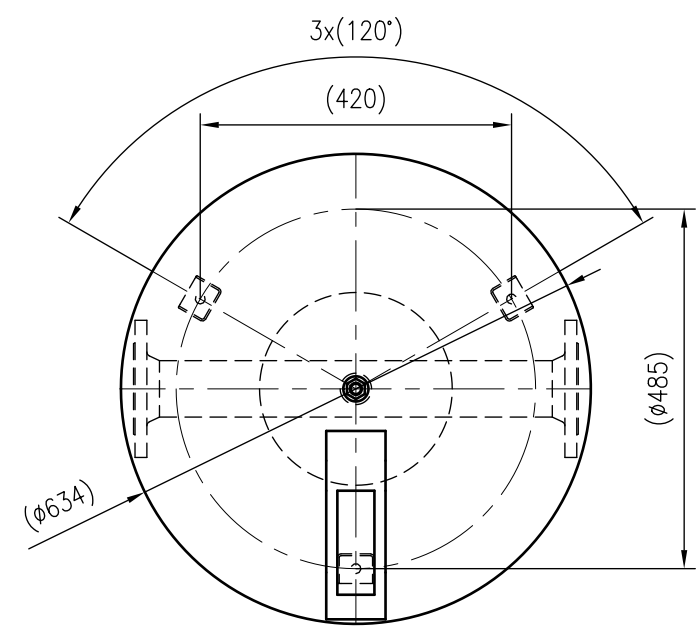

Top view



Unterliegt nicht dem Änderungsdienst/ Not subject to change management		Maßstab/ Scale: 1:10	Format/ Size: A3
Revision 19.12.2016	Reflex DT 200 10bar – 7365105		