

Side view

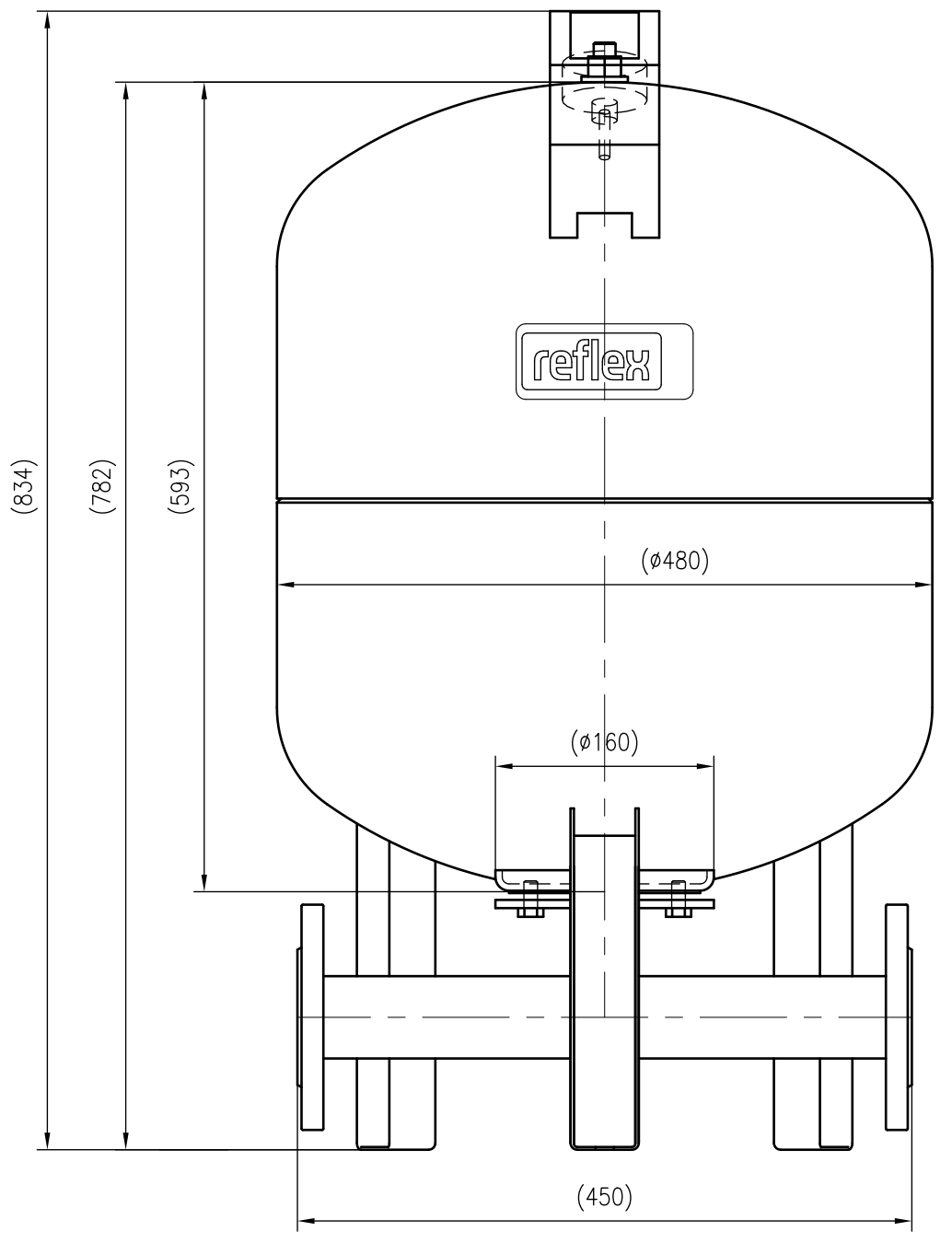

Front view

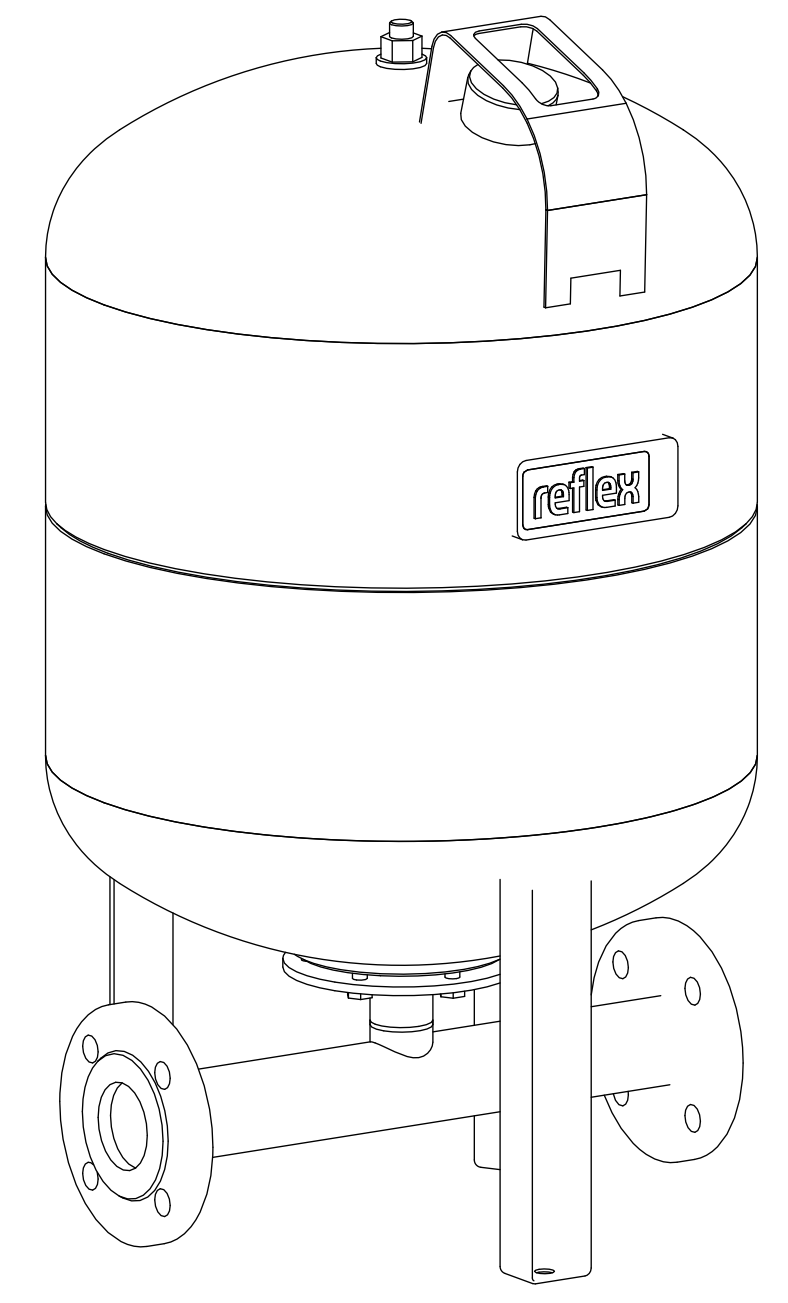

Isometric view

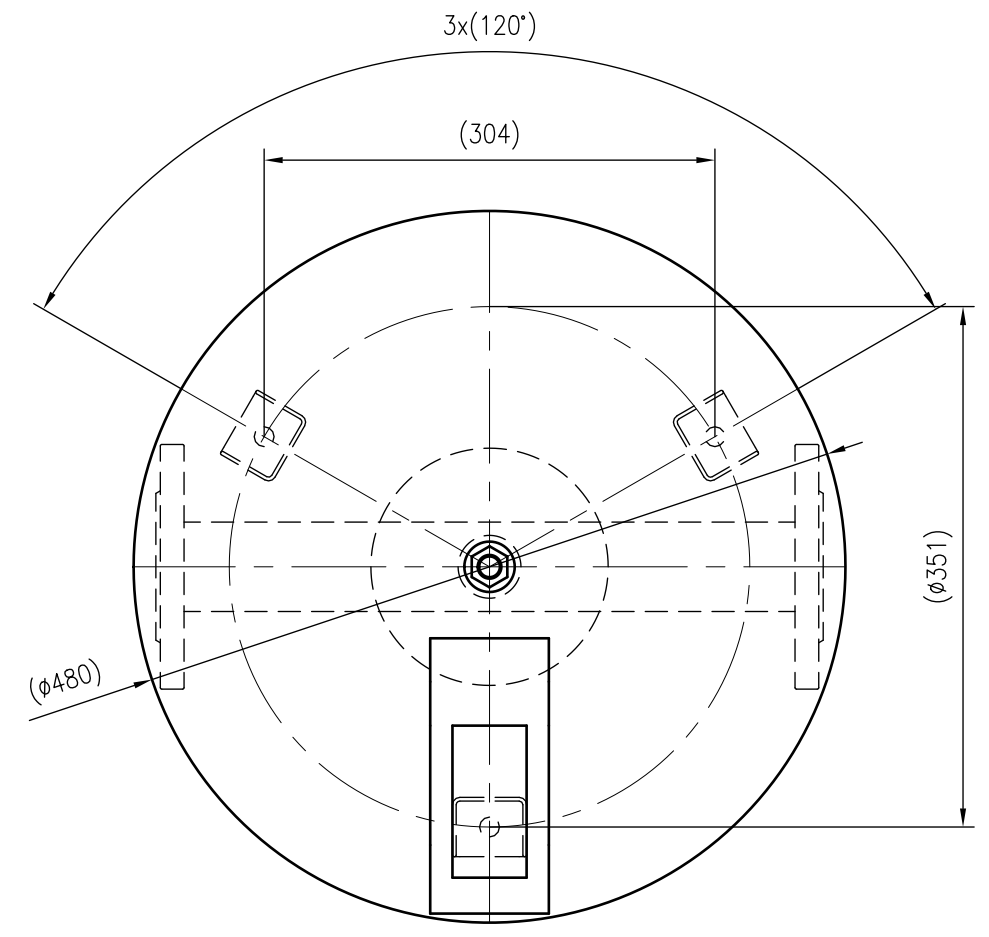

Top view



Unterliegt nicht dem Änderungsdienst/ Not subject to change management		Maßstab/ Scale: 1:5	Format/ Size: A2
Revision 04.05.2016	Reflex DT 100 16bar – 7370100		