

### Information on Print Material

**Note:** Individual handling instructions are representative for other print materials with identical handling. The graphics in these instructions only show the print material associated with this information.

<b>Item No.</b>	210-813
<b>Print material</b>	Label
<b>Print Material Intake</b>	Label reel holder in the WAGO Smart Printer thermal transfer printer
<b>Material</b>	Polyester
<b>Color</b>	white

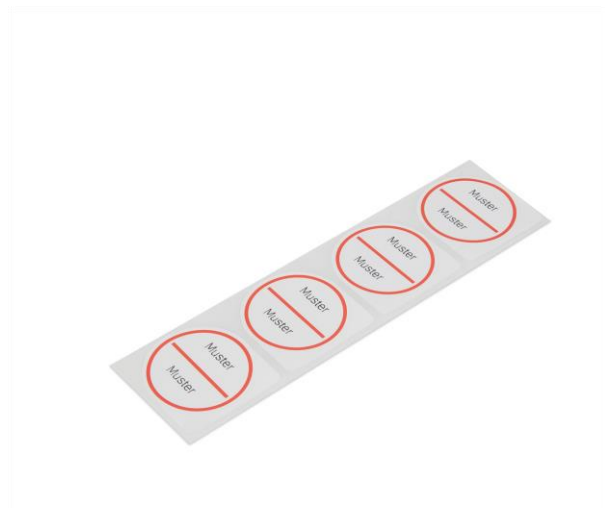

## 1. Hardware Preparation

### 1.1 Roller



Use roller **258-5006**.

### 1.2 Sensor Settings

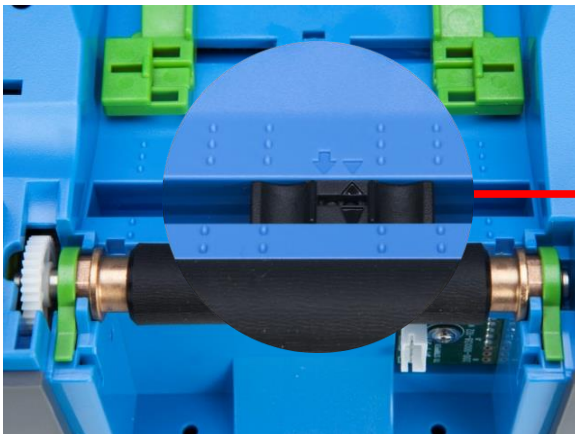

The tip of the triangle in the housing and the tip of the triangle on the sensor must point directly towards each other.

### 1.3 Load the Print Material and Align It

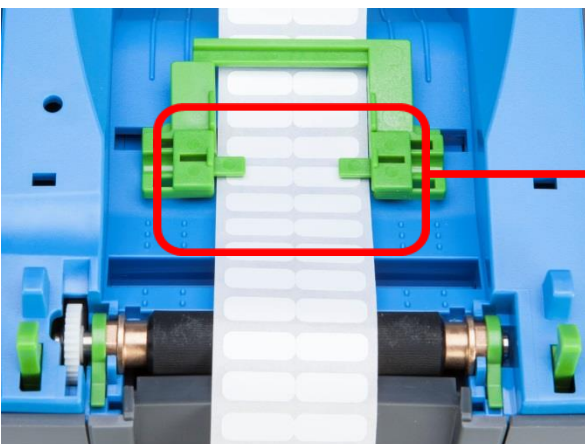

Set the guide to the print material width.  
Optimum setting:  
Maximum guide opening

## 2. WAGO Smart Script Marking Software – Creating Project Files

### Smart Script

Always use the most up-to-date version of the software. Check your existing installation to make sure that it is up to date, or download the newest version:

Link: [www.wago.com/smartprinter](http://www.wago.com/smartprinter)

Start Smart Script and select the following at the **[Projects]** level.

- 1 Specify a storage location for the project file.
- 2 Press the **[+ New project]** button.

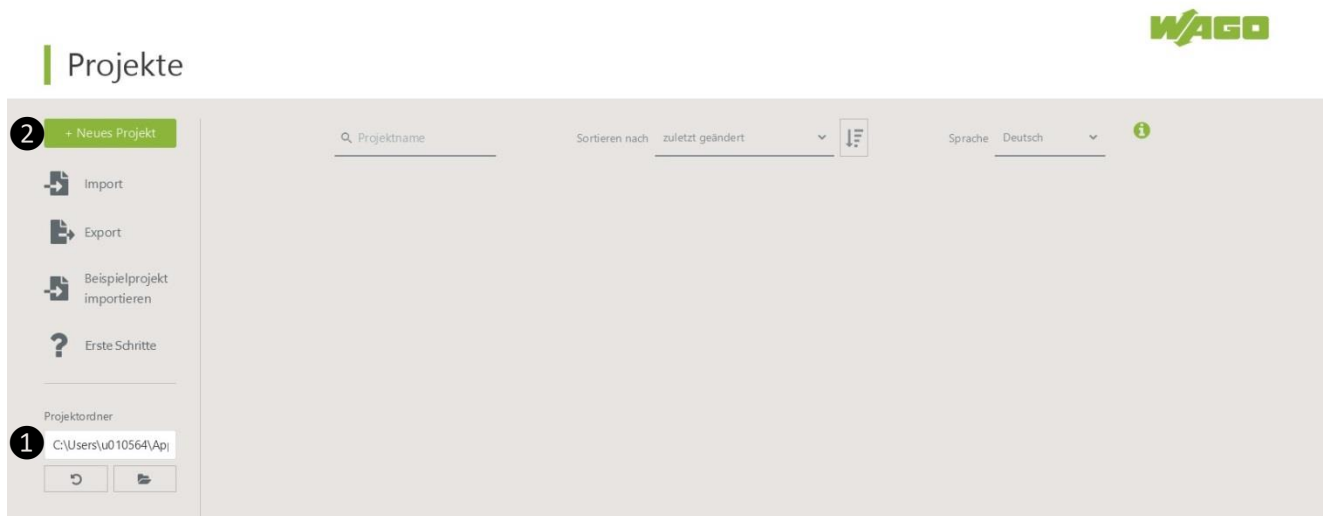

Figure 2.1

Enter a project name in the **[Project name]** box at the **[New project]** level.

The project name is assigned by Smart Script and consists of the word “Unnamed”, the creation date and the time when the project is created.

You can either accept the Smart Script project name, or enter your own project name here.

Position the mouse cursor in the input box **[Project name]** and click to enter your own project name.

- 1 Press the **[Select template]** button.

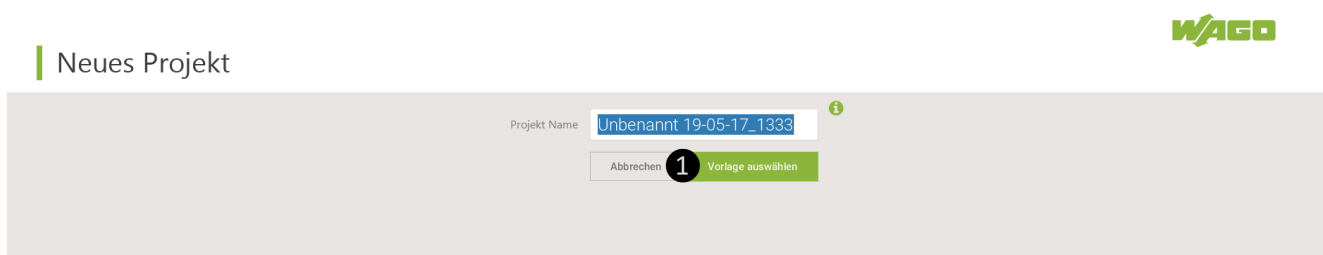

Figure 2.2



Figure 2.3

## 210-813 – Information on Handling Print Material

Select the Smart-Script template for your print material on the **[Templates]** level.

- 1 Enter the item number for the print material in the input box **[Template item number]**.
- 2 Select the template for the print material.

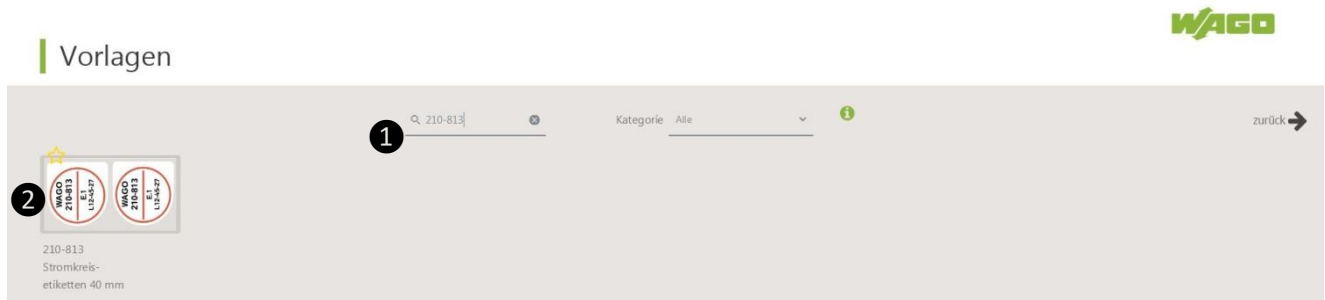

Figure 2.4

At the **[New project]** level

- 1 Press the **[Continue creating project]** button.



Figure 2.5

You are in the Smart Script work space. Your project is displayed.

In the sidebar, the tool “Automatic alignment” [  ] is activated. You can use this tool to exactly position marking boxes below one another and/or the print area.

- 1 Click in the area around the number 1. The marking box is activated.

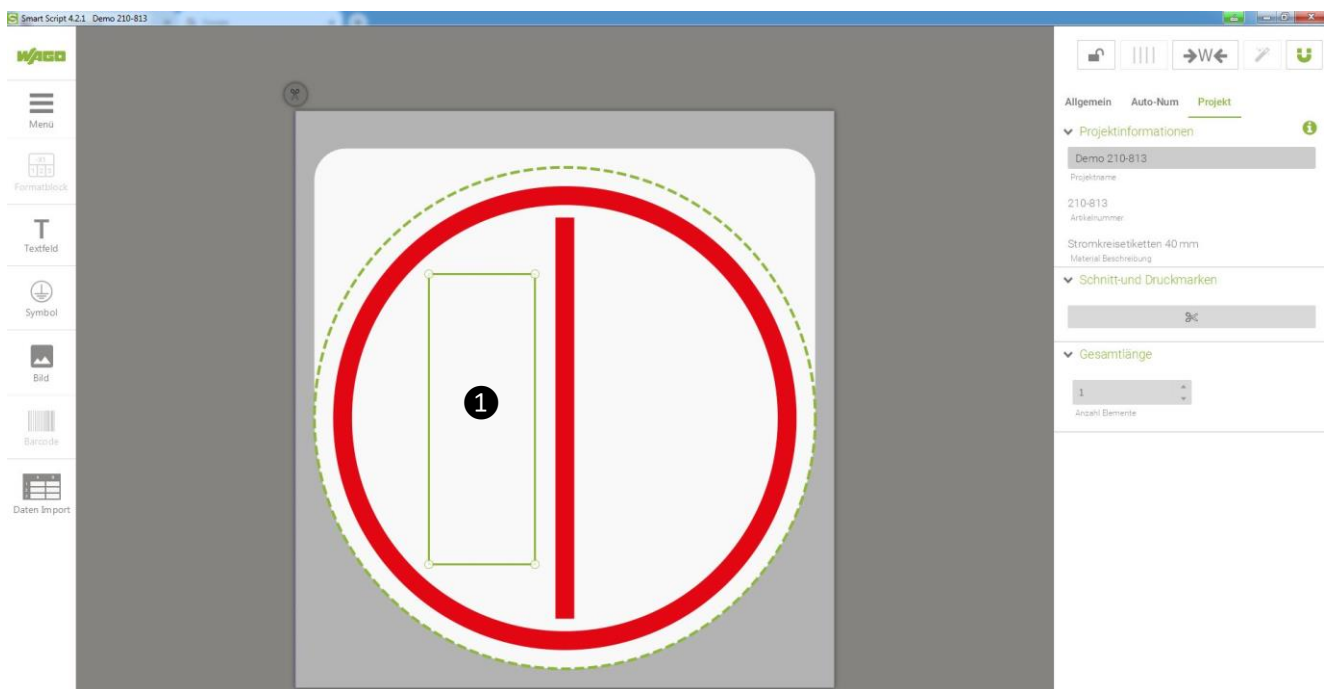

Figure 2.6

### Custom Marking

- 1 Double-click in a marking box.

In the active marking box the text is highlighted with a green background. Enter the label/caption text.

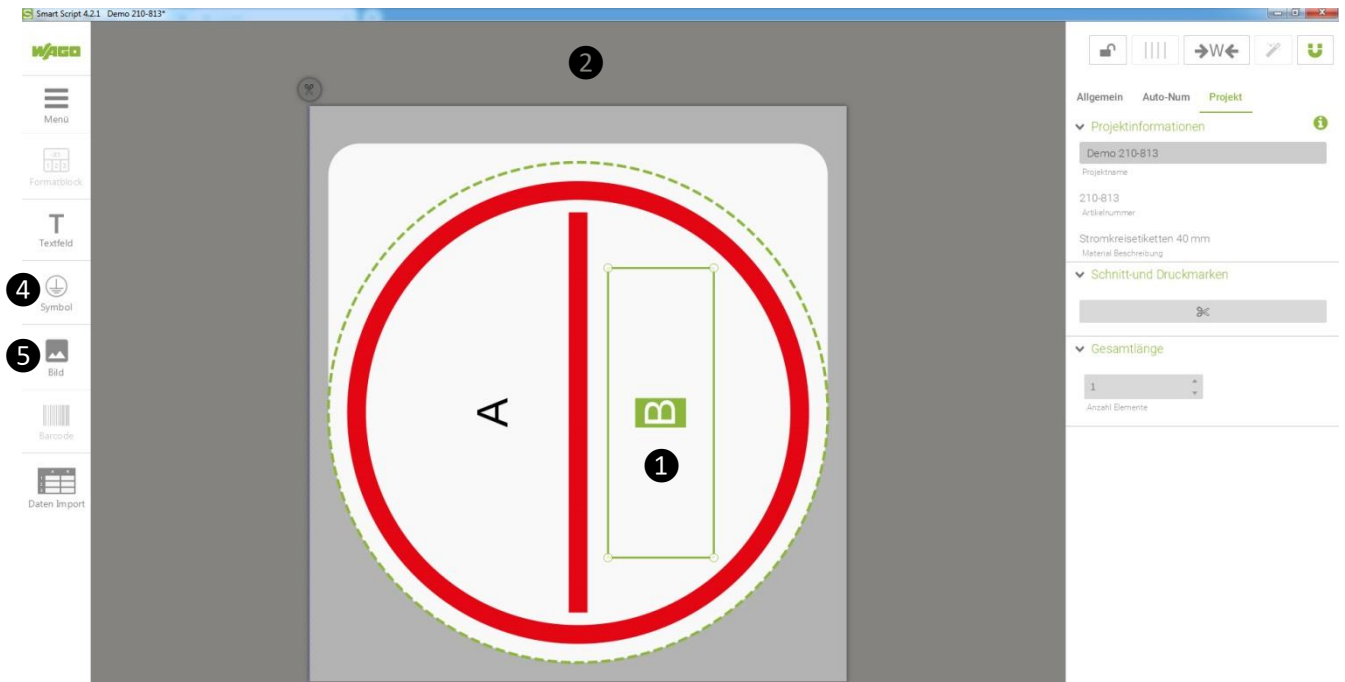

Figure 2.7

- 2 Click outside the marking box to accept the newly added text.
- or
- 3 Double-click in a different marking box to add text to it.
  - 4 In the menu bar select [**Symbol**]. Click on a symbol. That symbol is then added to its own text box and positioned in the template.
  - 5 In the menu bar select [**Image**]. Move to your image file. The image is then added to its own text box and positioned in the template.

### Formatting of Marking

You are in the Smart Script work space. Your project is displayed.

- 1 Select the **[General]** tab.
- 2 Tools in the area **[Alignment]**:
  - Cancel “Combine elements to a group/groups”.
  - Divide elements uniformly
  - Specify text box position by entering values.
  - Specify text box size by entering values.
  - Align text box contents.
- 3 Tools in the area **[Font type]**:
  - Font type/Size
  - Bold/Italic
  - Line spacing/Text extension
- 4 Tools in the area **[Frame]**:
  - Hide/Show text box frame.
  - Specify frame thickness.
- 5 Tools in the area **[Alignment]**:
  - Specify text position by entering values.

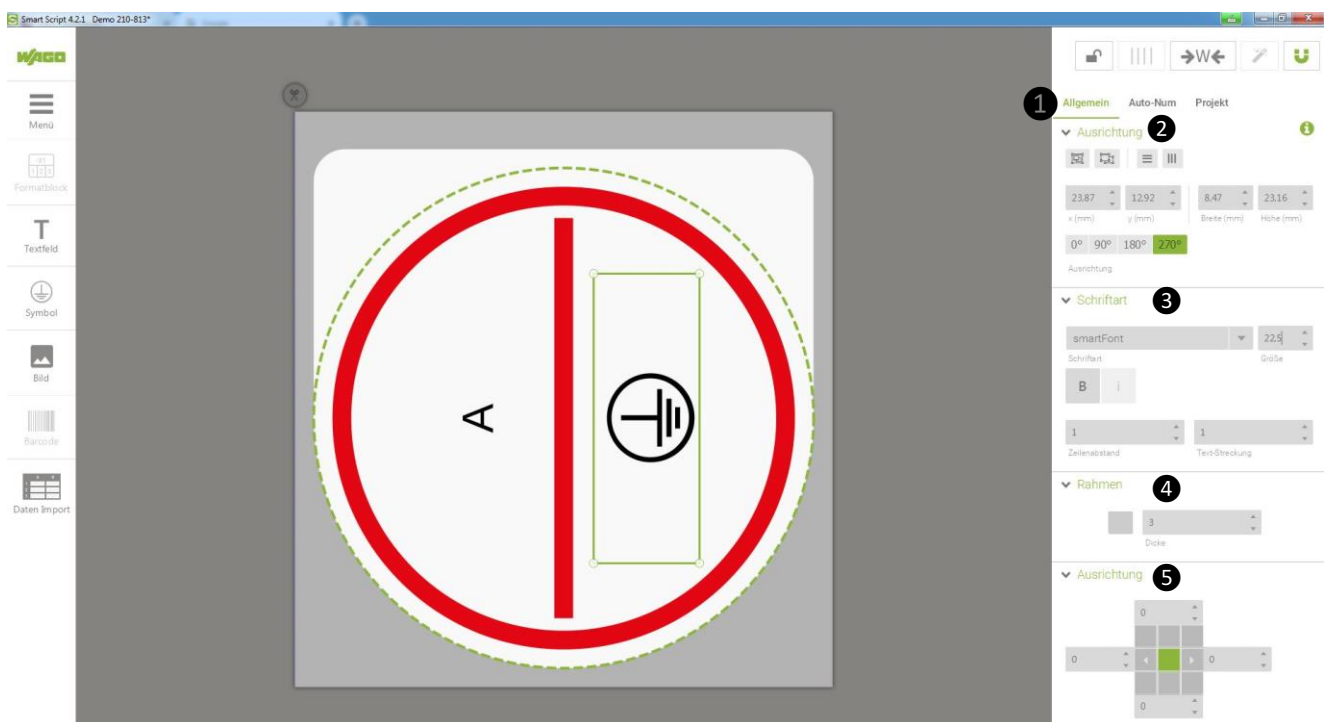

Figure 2.8

## Copying Marking Elements

- 1 Select the [Project] tab.
- 2 Enter the required number of elements. Further elements are added to the right of the original element.

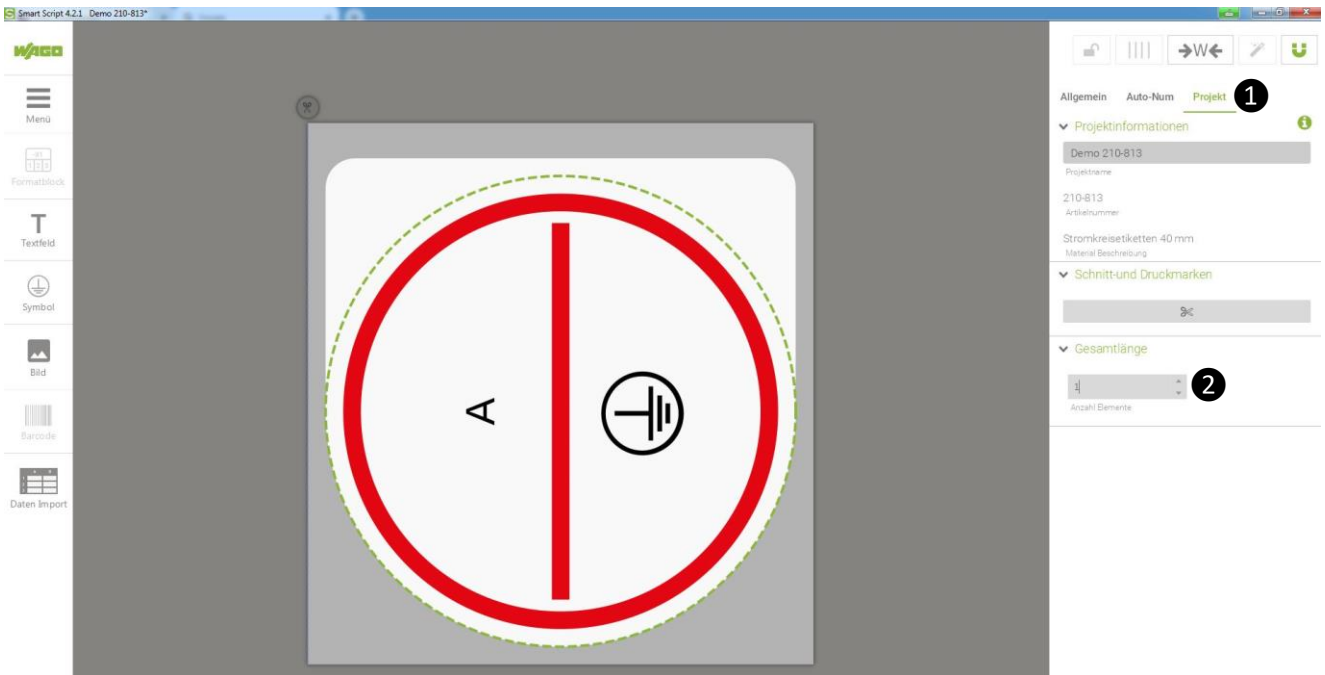

Figure 2.9

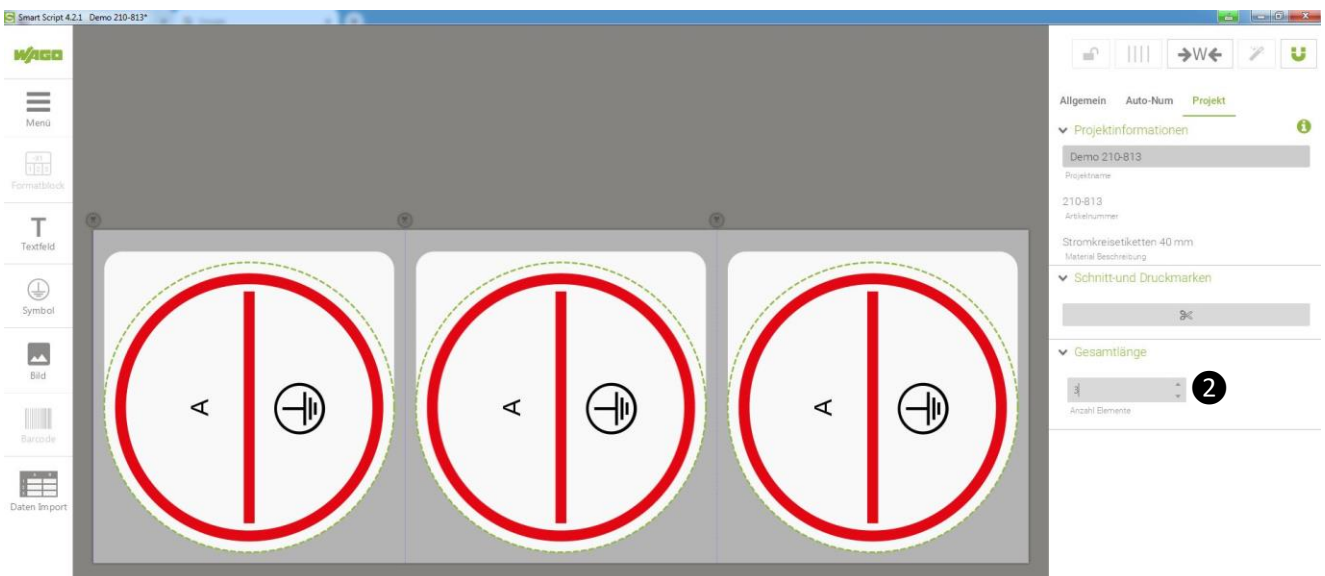

Figure 2.10

## 210-813 – Information on Handling Print Material

- 1 Select the **[Project]** tab.
- 2 Move the cursor to and click in a light gray area that surrounds the marking boxes. This area is then displayed with a green frame.
- 3 Click and hold down the mouse button on the icon . In the pop-up window enter the number of elements to be added to the left or right of the original element.

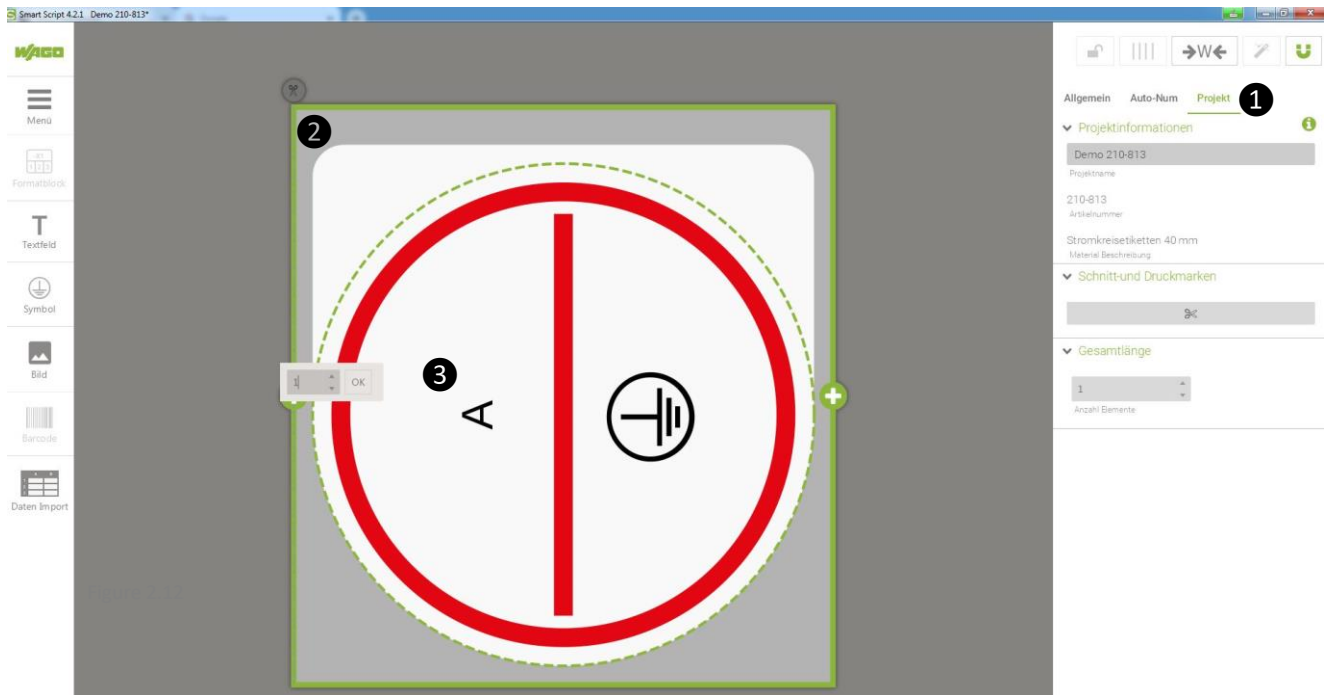

Figure 2.11

One element was added to the left of the original element.

The total number of elements is displayed in the sidebar area under **4 [Total length]**.

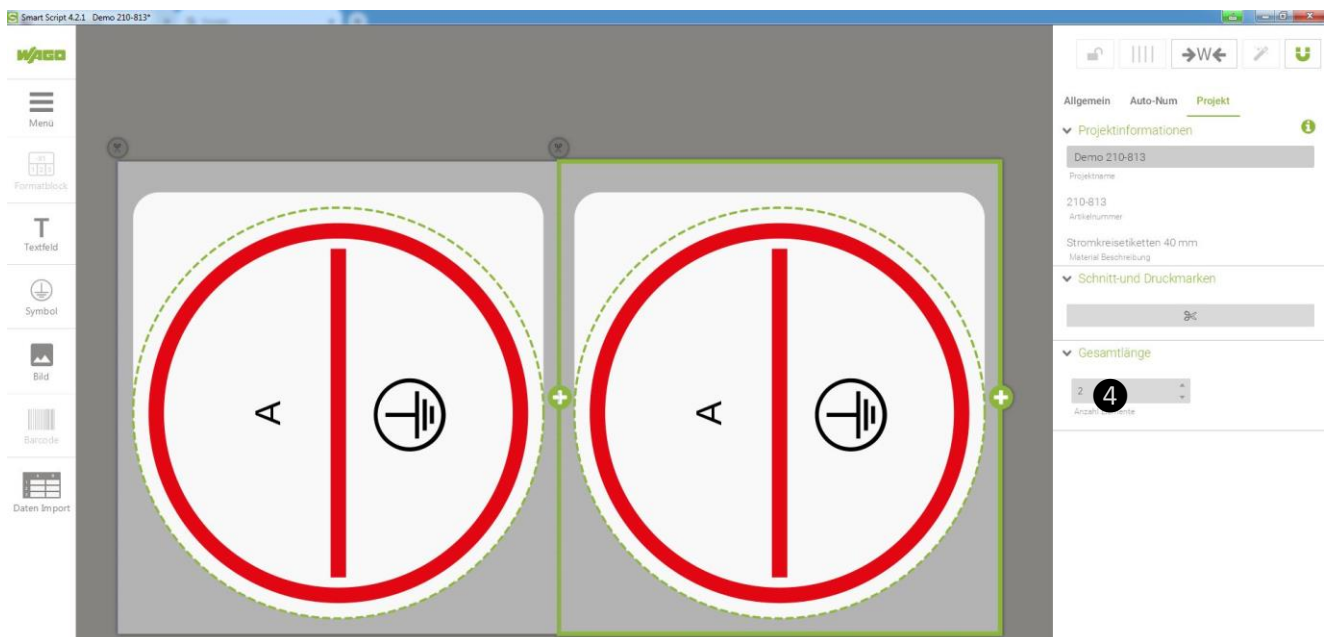



Figure 2.12

### Importing Markings

Smart Script supports importing of \*.xls, \*.xlsx, \*.txt, \*.csv and \*.dat files.

-  Press the ? button to call up the Smart Script online Help function.  
You can get more information about Smart Script functions in detailed tutorials.

### Setting crop and print marks

If you use the printer with the cutting unit you must set crop marks.

Crop marks are the positions in the project at which Smart Script evaluates a cut as logical.

When you select the template material at the beginning of your project, **[Crop and print marks]** will be available for use in the sidebar.

- 1 Click the button with the scissors icon to activate the application.

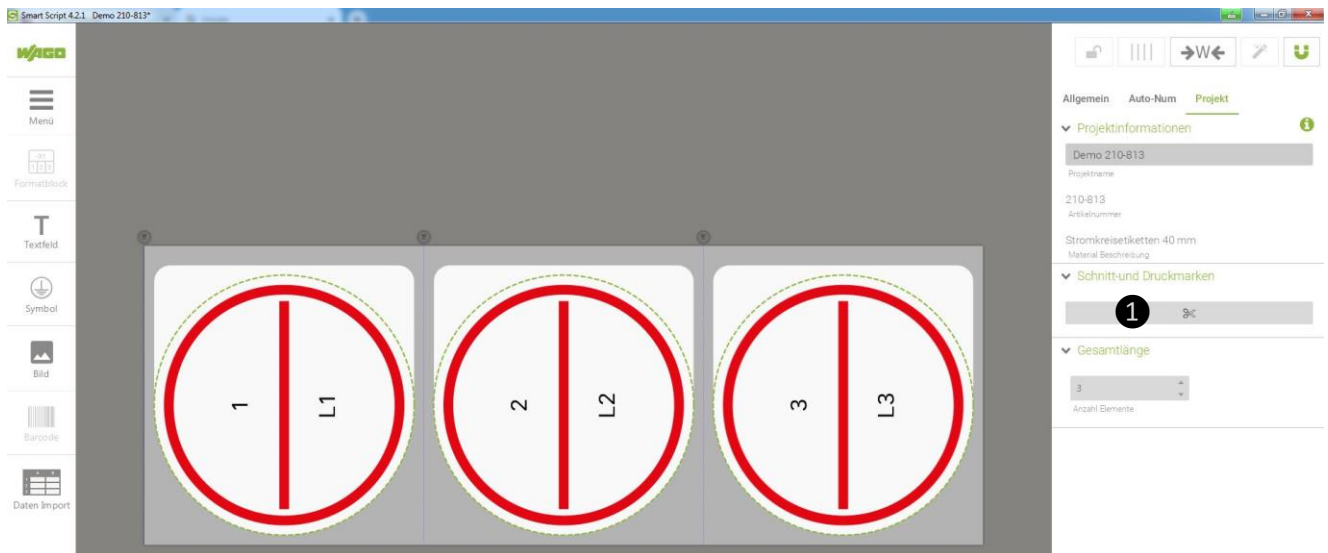

Figure 2.21

The button with the scissors symbol is green. These features can be used.

- 2 Press **[Activate all]**.

Smart Script places crop marks at the end of every element.

Crop mark position is correct = Crop mark is green.

- 3 Click on a print mark to deactivate it.
- 4 Click on a print mark to activate it.

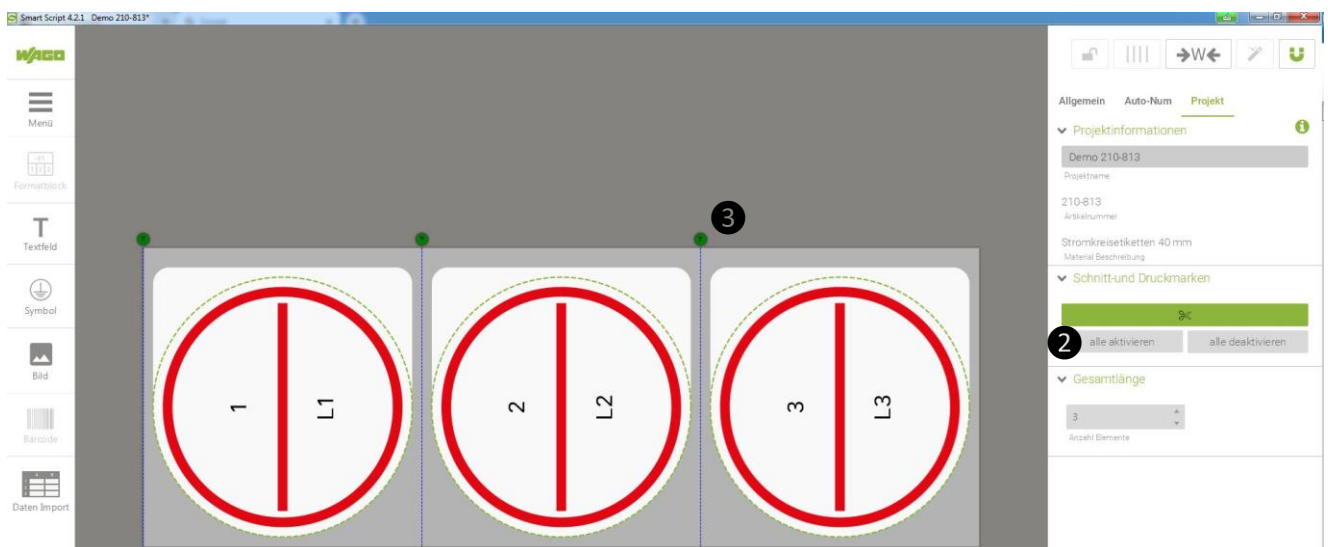

Figure 2.22

### 3. Print

Start the print job from Smart Script.

3 In the menu bar select **[Menu]**.

Then select menu item **[Print]**. The Print window opens.

Tip: Press **[Ctrl + P]** on your keyboard to open the Print window directly.



Figure 3.1

In the Smart Script Print window select the printer in the **[Settings]** sidebar and specify the number of print copies.

1 Press **[Print]**. Printing of the project then starts.

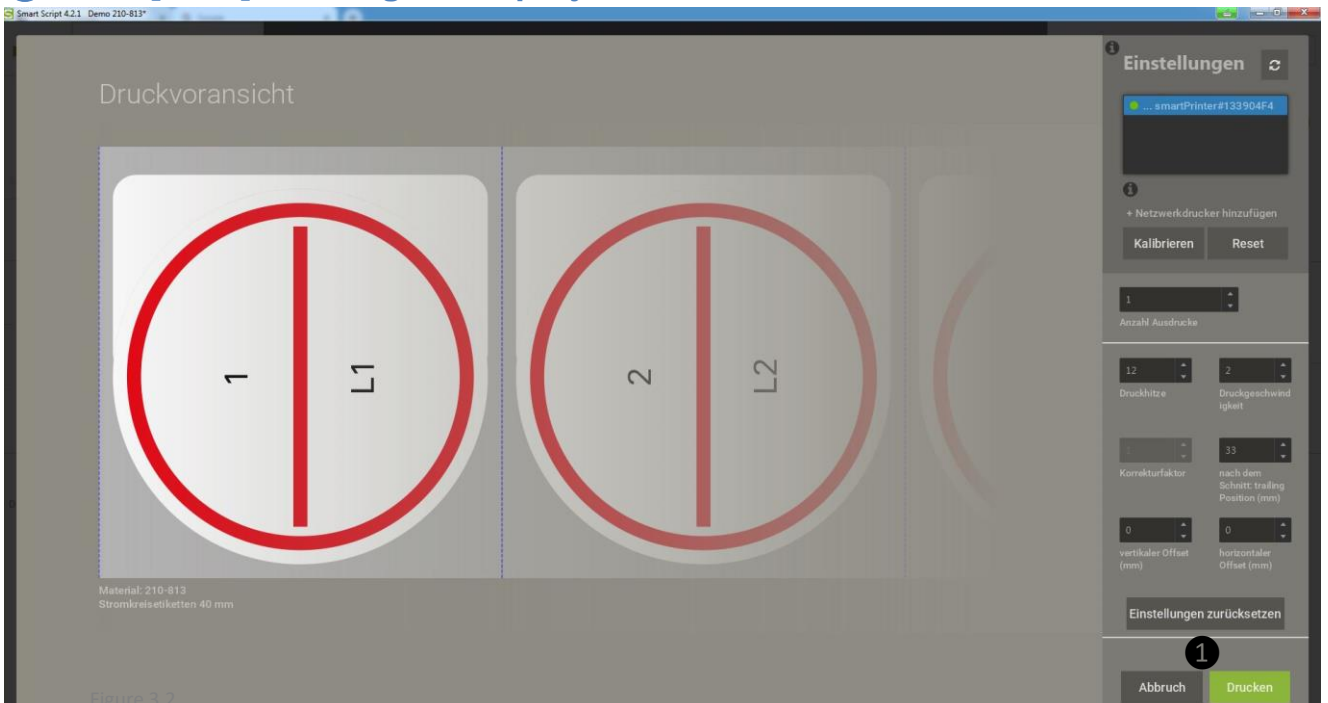
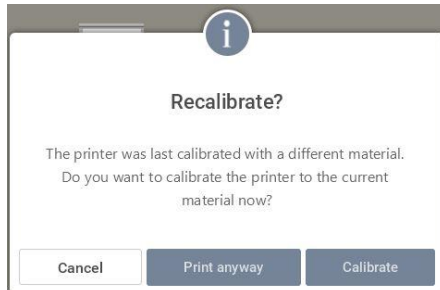

Figure 3.2

### Calibrate the Printer

The WAGO Marking Software Smart Script detects if the calibration of the printer matches the marking accessory to be printed. If this is not the case, the print job is stopped.

The **[Recalibrate?]** dialog opens.



Press the **[Cancel]** button to cancel the print job.

Press the **[Print anyway]** if you want to override the dialog information. The print job is started.

Press the **[Calibrate]**, if you want to optimize the printer, the inserted marking accessory and your Smart Script project. The print job is canceled and the printer is calibrated.



Press the ? button to call up the Smart Script online Help function.

You can get more information about Smart Script function **[Calibrate]** in detailed tutorials.

## 4. Correcting Print Quality

WAGO Smart Script marking software allows you to correct the printing quality of the labeling text afterwards. The procedure described in this chapter is representative of all print materials.

Description of defects:

- The labeling text is not printed vertically centered.  
The labeling text is moved up or down (Figure 1).
- The labeling text is not printed centered horizontally.  
The labeling text is moved to the right (Fig 2).
- The labeling text is faint or has not been completely printed (Fig 3).

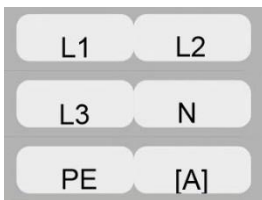

Fig. 1: Moved vertically



Fig. 2: Moved horizontally



Fig. 3: Print-out faint and incomplete

Change the values in the input boxes in the **[Settings]** sidebar of the Smart Script Print window.

Correction option by changing values:

- Increase the **[Vertical Offset(mm)]** value. = The labeling text is moved up.  
Decrease the **[Verticaler Offset(mm)]** value. = The labeling text is moved down.
- Increase the **[Horizontal Offset(mm)]** value. = The labeling text is moved to the right.  
Decrease the **[Horizontal Offset(mm)]** value. = The labeling text is moved to the left (Firmware 1.UW7U).
- Decrease the **[Printing darkness]** value. = Labeling text gets lighter.  
**Attention!** A value >12 might damage the color ribbon.

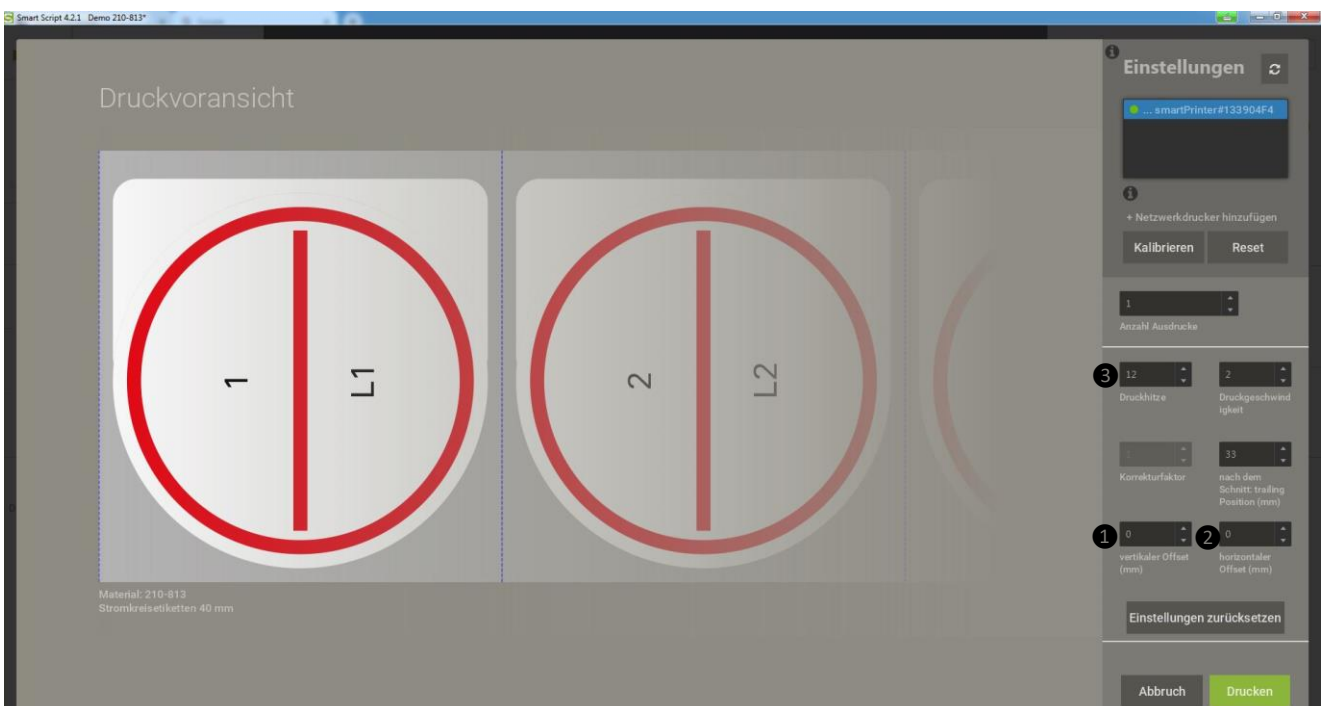

Figure 4.1

## 210-813 – Information on Handling Print Material

---

Now perform some test printouts.

The printer needs the test printouts to adjust and implement the correction values.