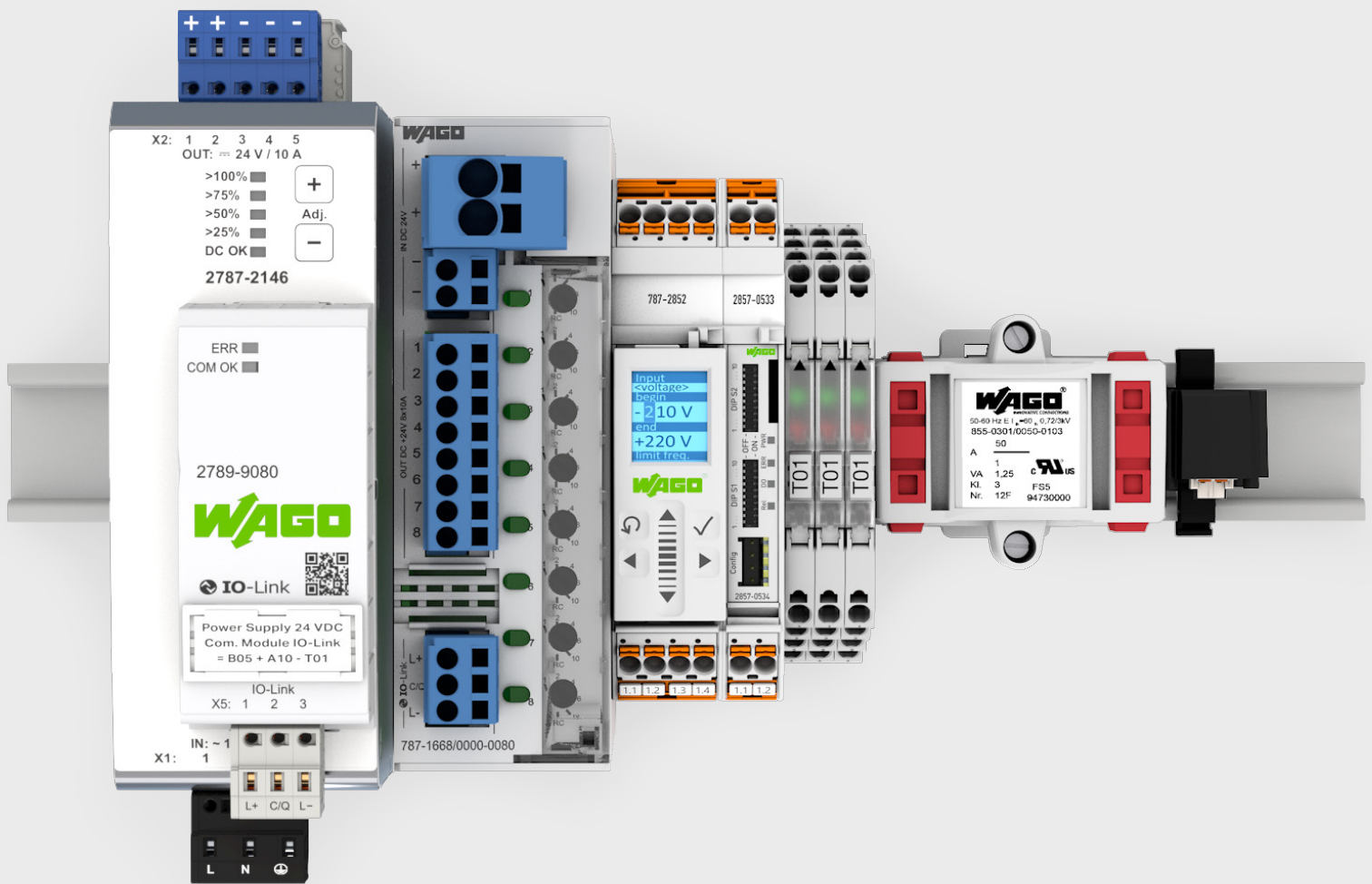




WAGO Electronic Interface

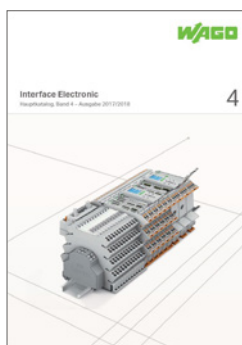
Product Overview





Contents

Signal Conditioners	4-21
Current and Energy Measurement Technology	22-37
Power Supplies and System Modules	38-53
Relay and Optocoupler Modules	54-63
Interface Modules	64-67



This "Electronic Interface" overview highlights industry-leading technologies from WAGO's comprehensive range of interface products. Additional information on the entire product portfolio is available in the WAGO Full Line Catalog, Electronic Interface, Volume 4. www.wago.com

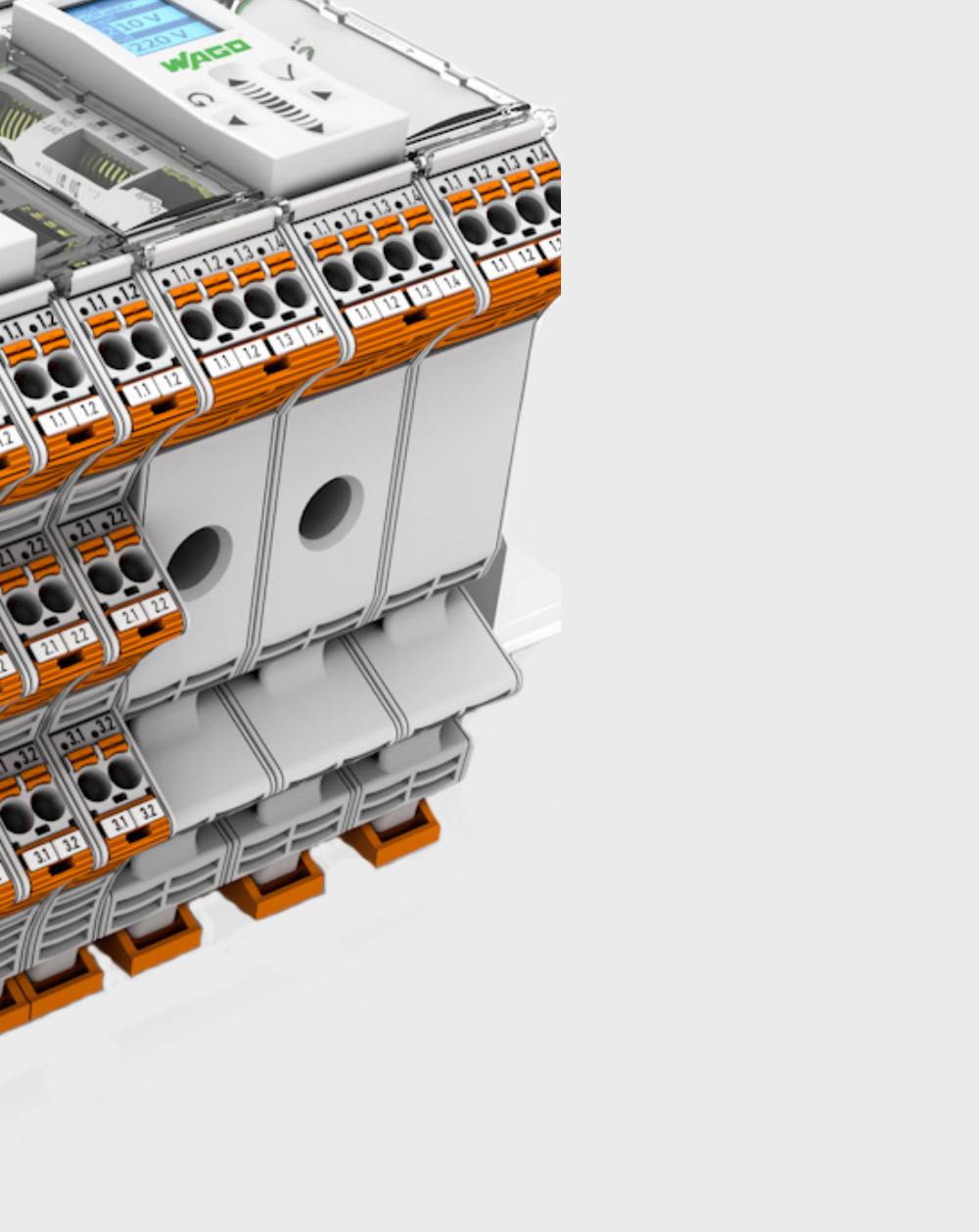


WAGO Signal Conditioners

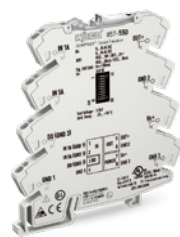
Product Overview

The development of WAGO's signal conditioners was driven by customers' needs for greater flexibility during system planning, while maintaining uniformity in the cabinet. The advantage rests in the palm of your hand: There is no need to wire each individual component, thanks to push-in jumpers that save time and effort. Tightly

integrating the desirable mechanical and electrical characteristics of the signal conditioners has led to a series of unique features that continue to set the standard for signal conditioners. The product range is supplemented with the new line of WAGO 3-Phase Power Measurement Modules in a DIN-rail-mount enclosure.



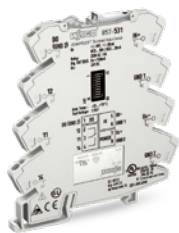
Signal Conditioners



Current and Voltage Signal Conditioners



Temperature Signal Conditioners



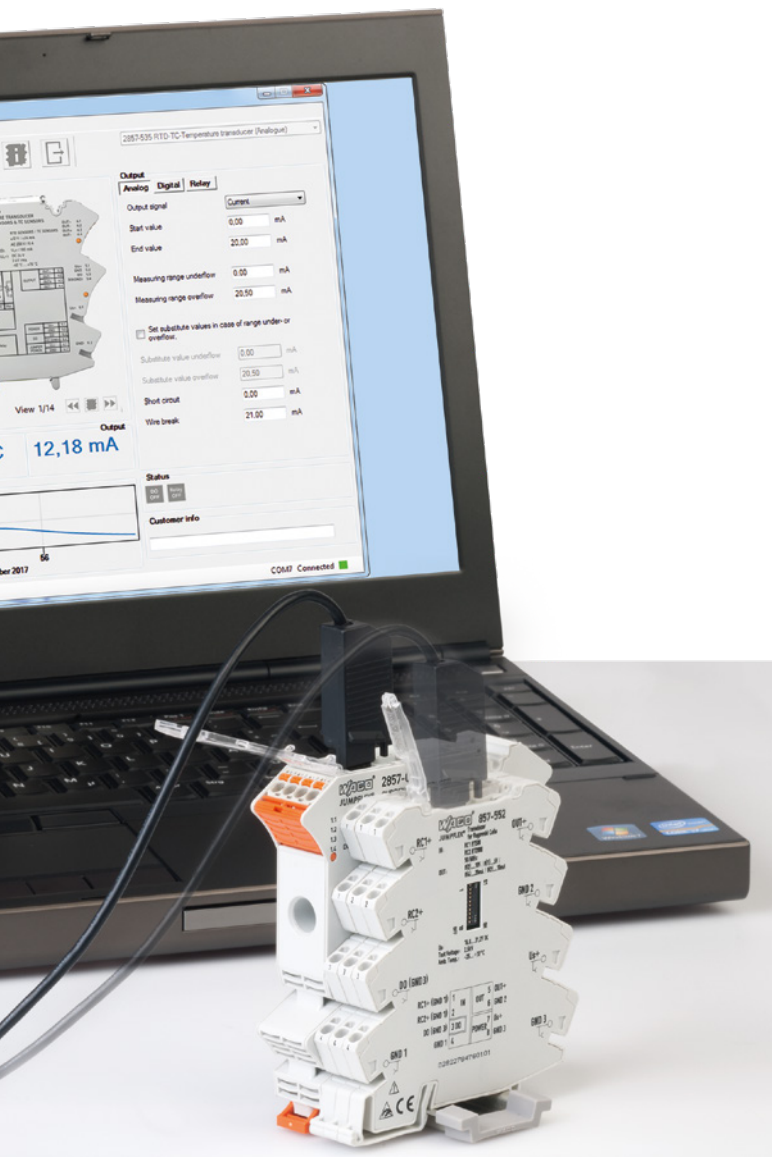
Threshold Value Switches



Signal Conditioners with Special Functions



Power Measurement Modules



Versatile Configuration Options

Interface Configuration Software

Signal conditioners with a service interface offer user-friendly configuration at a glance using the interface configuration software.



Free software download from:
www.wago.com

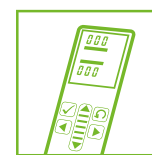
Software features:

- Automatic module recognition
- Simulation of input and output parameters (2857 Series)
- Configuration and visualization of process values
- Parameterization of the digital switch output (threshold functionality)
- Communication via WAGO USB Service Cable (750-923) or WAGO Bluetooth® Adapter (750-921), pluggable on both series
- Creation of configuration reports
- Backup of configuration settings

Configuration Display for 2857 Series

Flexibility at its Finest!

The removable display can be quickly and easily attached to the 2857 Series. It includes an innovative capacitive touch panel for intuitively configuring devices. Passwords for protecting configured data may be assigned to prevent unauthorized access and changes.



Configuration Display for 2857 Series



Configuration App

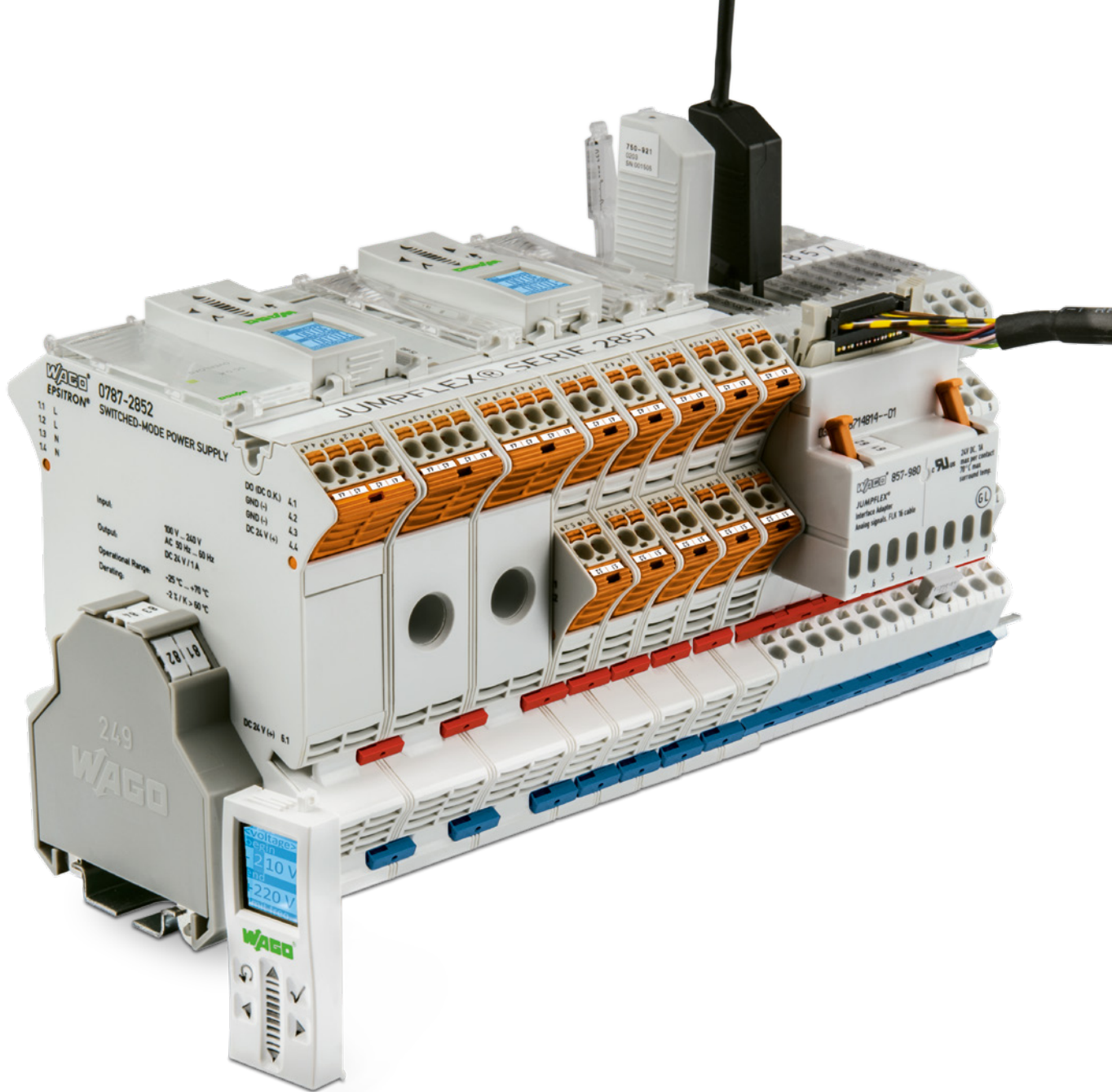
The free app brings the power of PC-based configuration software to your Android smartphone or tablet. Free download from Google Play Store



App features:

- Configuration of input and output parameters with a single click
- Simple display of configuration data and current value
- Communication via WAGO Bluetooth® Adapter (750-921)





Maximum Safety!

All devices provide "safe isolation" with 2.5–4 kV test voltage per DIN EN 61010-1



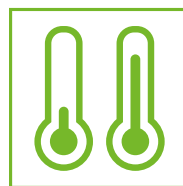
Commoning, Not Discrete Wiring

Same profile allows the use of a single in-line, push-in jumper



Reliable Connection Technology

Push-In CAGE CLAMP® and WAGO *picoMAX*® Pluggable Connectors provide time savings and maintenance-free connections of all conductor types



For Extreme Temperatures

Extended temperature range from –40°C to +70°C to support more applications



Continuous Marking

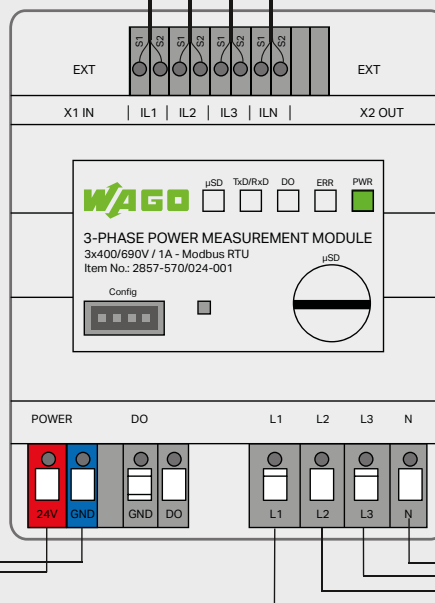
With WMB and TOPJOB® S Marking Systems

Application Example

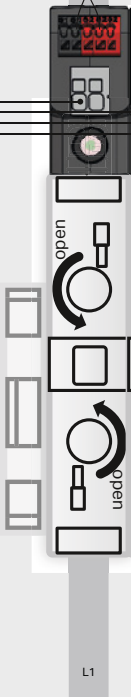
Power Supply
787-2850



3-Phase
Power Measurement Module
2857-570 / 024-000



Supply



WAGO 3-Phase Power Measurement Module

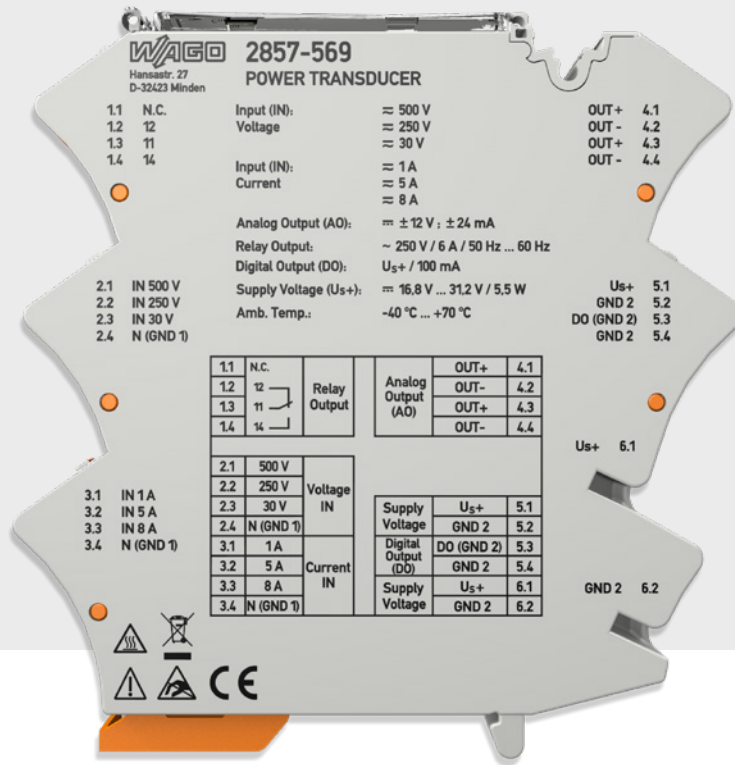
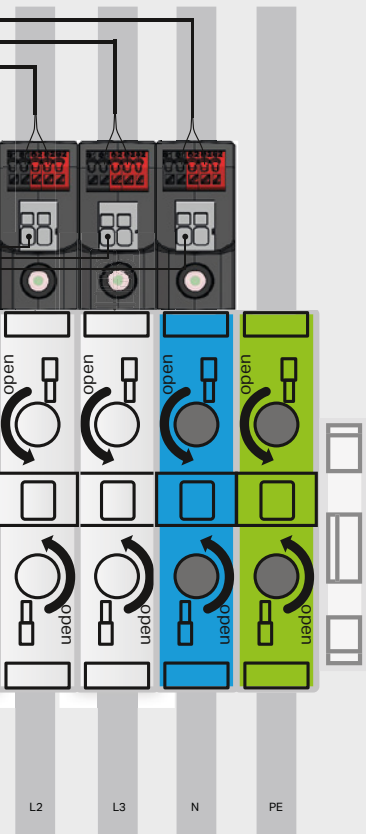
Measure Electrical Data in Three-Phase Supply Networks

For successful energy management, consumption values of machines and systems must be known. With the 3-Phase Power Measurement Module in a DIN-rail-mount enclosure, WAGO offers the ideal solution to remotely measure currents and voltages in a three-phase supply network from the control level. Measured variables such as active/apparent/reactive power, energy consumption, power factor, phase angle and frequency can be accessed via Modbus® interface. Two integrated RJ-45 sockets streamline the interconnection of up to 32 devices. In addition, the 3-Phase Power Measurement Module can log the corresponding measured variables onto a microSD card. Simple configuration and display of measured variables using WAGO's Interface Configuration Software enable the user to perform comprehensive data analysis.

Your benefits:

- Flexible selection of upcoming measurement tasks
- **Slot for microSD cards:** Fast and secure mobile measurement, including recording
- **Compact device in DIN-rail-mount enclosure:** Saves space in building technology
- **Modbus® Interface (RS-485):** Provision of the measured values via Modbus®
- **Digital signal output as pulse output (pulses/kWh are configurable):** Continuous energy consumption monitoring

Additional information on WAGO's energy management solutions can be found here: www.wago.com/energymanagement



WAGO 1-Phase Power Measurement Module

Measures Current, Voltage and Power













WAGO's 1-Phase Power Measurement Module directly measures both DC and AC currents up to 8 A, as well as DC and AC voltages up to 500 V. Measured variables – such as current, voltage, all power types and many more – can be flexibly configured and evaluated in the configuration software or directly on the device display. It also monitors, reports and displays signal statuses with up to two switching thresholds and provides these statuses to a higher-level PLC via an analog or serial interface. To use this power measurement module as a current, voltage or power threshold switch, a relay and digital output are integrated.

Your benefits:

- Display connection for display and configuration
- Simulation of input/output response for quick start-up
- Additional digital signal output for configured measurement range limits

Technical Details








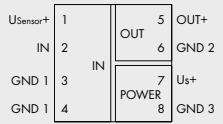

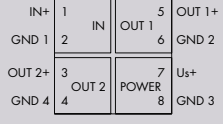

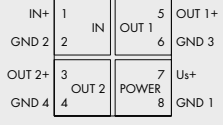

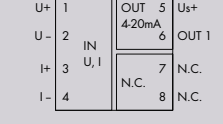

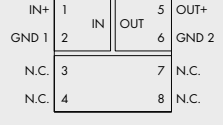

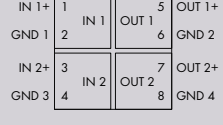
WAGO Signal Conditioners










Description		Image	Circuit Diagram	Input			Output																																	
 Signal Conditioners																																								
Universal Signal Conditioner			<table border="1"> <tr> <td>1.1</td> <td>U+</td> <td rowspan="2">INPUT VOLTAGE</td> <td rowspan="2">OUTPUT</td> <td>OUT+</td> <td>4.1</td> </tr> <tr> <td>1.2</td> <td>U-</td> <td>OUT-</td> <td>4.2</td> </tr> <tr> <td>2.1</td> <td>I+</td> <td rowspan="2">INPUT CURRENT</td> <td rowspan="2">POWER</td> <td>U_s+</td> <td>5.1</td> </tr> <tr> <td>2.2</td> <td>I-</td> <td>GND</td> <td>5.2</td> </tr> <tr> <td>3.1</td> <td>DO (GND)</td> <td>DO</td> <td>JUMPER</td> <td>U_s+</td> <td>6.1</td> </tr> <tr> <td>3.2</td> <td>DI (HOLD)</td> <td>DI (HOLD)</td> <td>POWER</td> <td>GND</td> <td>6.2</td> </tr> </table>	1.1	U+	INPUT VOLTAGE	OUTPUT	OUT+	4.1	1.2	U-	OUT-	4.2	2.1	I+	INPUT CURRENT	POWER	U _s +	5.1	2.2	I-	GND	5.2	3.1	DO (GND)	DO	JUMPER	U _s +	6.1	3.2	DI (HOLD)	DI (HOLD)	POWER	GND	6.2	0 ... 1 mA 0 ... 10 mA 2 ... 10 mA 0 ... 20 mA 4 ... 20 mA 0 ... 100 mA	0 ... 5 V 1 ... 5 V 0 ... 10 V 2 ... 10 V 0 ... 220 V	±1 mA ±10 mA ±20 mA ±100 mA ±1 V ±10 V ±30 V ±100 V ±200 V	0 ... 10 mA 2 ... 10 mA 0 ... 20 mA 4 ... 20 mA	0...5V 1...5V 0...10V 2...10V
1.1	U+	INPUT VOLTAGE	OUTPUT	OUT+	4.1																																			
1.2	U-			OUT-	4.2																																			
2.1	I+	INPUT CURRENT	POWER	U _s +	5.1																																			
2.2	I-			GND	5.2																																			
3.1	DO (GND)	DO	JUMPER	U _s +	6.1																																			
3.2	DI (HOLD)	DI (HOLD)	POWER	GND	6.2																																			
Signal Conditioner; configurable; with zero/span adjustment			<table border="1"> <tr> <td>IN+</td> <td>1</td> <td rowspan="2">IN</td> <td rowspan="2">OUT</td> <td>5</td> <td>OUT+</td> </tr> <tr> <td>GND 1</td> <td>2</td> <td>6</td> <td>GND 2</td> </tr> <tr> <td>U_s+</td> <td>3</td> <td rowspan="2">POWER</td> <td rowspan="2">POWER</td> <td>7</td> <td>U_s+</td> </tr> <tr> <td>GND 3</td> <td>4</td> <td>8</td> <td>GND 3</td> </tr> </table>	IN+	1	IN	OUT	5	OUT+	GND 1	2	6	GND 2	U _s +	3	POWER	POWER	7	U _s +	GND 3	4	8	GND 3	0 ... 10 mA 2 ... 10 mA 0 ... 20 mA 4 ... 20 mA	0 ... 5 V 1 ... 5 V 0 ... 10 V 2 ... 10 V		0 ... 20 mA 4 ... 20 mA	0...5V 1...5V 0...10V 2...10V												
IN+	1	IN	OUT	5	OUT+																																			
GND 1	2			6	GND 2																																			
U _s +	3	POWER	POWER	7	U _s +																																			
GND 3	4			8	GND 3																																			
Signal Conditioner; configurable; with digital output			<table border="1"> <tr> <td>IN+</td> <td>1</td> <td rowspan="2">IN</td> <td rowspan="2">OUT</td> <td>5</td> <td>OUT+</td> </tr> <tr> <td>GND 1</td> <td>2</td> <td>6</td> <td>GND 2</td> </tr> <tr> <td>DO</td> <td>3</td> <td rowspan="2">DO</td> <td rowspan="2">POWER</td> <td>7</td> <td>U_s+</td> </tr> <tr> <td>GND 3</td> <td>4</td> <td>8</td> <td>GND 3</td> </tr> </table>	IN+	1	IN	OUT	5	OUT+	GND 1	2	6	GND 2	DO	3	DO	POWER	7	U _s +	GND 3	4	8	GND 3	0 ... 10 mA 2 ... 10 mA 0 ... 20 mA 4 ... 20 mA	0 ... 5 V 1 ... 5 V 0 ... 10 V 2 ... 10 V	±20 mA ±10 V	0 ... 10 mA 2 ... 10 mA 0 ... 20 mA 4 ... 20 mA	0...5V 1...5V 0...10V 2...10V												
IN+	1	IN	OUT	5	OUT+																																			
GND 1	2			6	GND 2																																			
DO	3	DO	POWER	7	U _s +																																			
GND 3	4			8	GND 3																																			
Universal Signal Conditioner			<table border="1"> <tr> <td>U+</td> <td>1</td> <td rowspan="2">IN</td> <td rowspan="2">OUT</td> <td>5</td> <td>OUT+</td> </tr> <tr> <td>I+</td> <td>2</td> <td>6</td> <td>OUT-</td> </tr> <tr> <td>I+</td> <td>3</td> <td rowspan="2">POWER</td> <td rowspan="2">POWER</td> <td>7</td> <td>U_s+</td> </tr> <tr> <td>I-/U-</td> <td>4</td> <td>8</td> <td>GND 3</td> </tr> </table>	U+	1	IN	OUT	5	OUT+	I+	2	6	OUT-	I+	3	POWER	POWER	7	U _s +	I-/U-	4	8	GND 3	0 ... 0.3 mA to 0 ... 100 mA	0 ... 60 mV to 0 ... 200 V	±0.3 mA to ±100 mA ±60 mV to ±200 V	0 ... 20 mA 4 ... 20 mA	0...5V 1...5V 0...10V 2...10V												
U+	1	IN	OUT	5	OUT+																																			
I+	2			6	OUT-																																			
I+	3	POWER	POWER	7	U _s +																																			
I-/U-	4			8	GND 3																																			
Bipolar Signal Conditioner			<table border="1"> <tr> <td>U+</td> <td>1</td> <td rowspan="2">IN</td> <td rowspan="2">OUT</td> <td>5</td> <td>OUT+</td> </tr> <tr> <td>U-</td> <td>2</td> <td>6</td> <td>OUT-</td> </tr> <tr> <td>I+</td> <td>3</td> <td rowspan="2">POWER</td> <td rowspan="2">POWER</td> <td>7</td> <td>U_s+</td> </tr> <tr> <td>I-</td> <td>4</td> <td>8</td> <td>GND</td> </tr> </table>	U+	1	IN	OUT	5	OUT+	U-	2	6	OUT-	I+	3	POWER	POWER	7	U _s +	I-	4	8	GND	0 ... 10 mA 2 ... 10 mA 0 ... 20 mA 4 ... 20 mA	0 ... 5 V 1 ... 5 V 0 ... 10 V 2 ... 10 V	±10 mA ±20 mA ±5 V ±10 V	0 ... 10 mA 2 ... 10 mA 0 ... 20 mA 4 ... 20 mA	0...5V 1...5V 0...10V 2...10V												
U+	1	IN	OUT	5	OUT+																																			
U-	2			6	OUT-																																			
I+	3	POWER	POWER	7	U _s +																																			
I-	4			8	GND																																			
Signal Conditioners; pre-configured			<table border="1"> <tr> <td>IN+</td> <td>1</td> <td rowspan="2">IN</td> <td rowspan="2">OUT</td> <td>5</td> <td>OUT+</td> </tr> <tr> <td>GND 1</td> <td>2</td> <td>6</td> <td>GND 2</td> </tr> <tr> <td>U_s+</td> <td>3</td> <td rowspan="2">POWER</td> <td rowspan="2">POWER</td> <td>7</td> <td>U_s+</td> </tr> <tr> <td>GND 3</td> <td>4</td> <td>8</td> <td>GND 3</td> </tr> </table>	IN+	1	IN	OUT	5	OUT+	GND 1	2	6	GND 2	U _s +	3	POWER	POWER	7	U _s +	GND 3	4	8	GND 3	0(4) ... 20 mA			0(4) ... 20 mA													
				IN+	1			IN	OUT	5	OUT+																													
				GND 1	2	6	GND 2																																	
				U _s +	3	POWER	POWER	7	U _s +																															
				GND 3	4			8	GND 3																															
					0(2) ... 10 V			0(2) ... 10 V																																
	0 ... 10 V		0 ... 20 mA																																					
	0 ... 10 V		4 ... 20 mA																																					
	0 ... 20 mA				0...10V																																			
	4 ... 20 mA				0...10V																																			

	Special Functions				Configuration					Power Supply	Item No.	EAN No.
												
±12 V ±24 mA	x	x		x	x		x	x	x	24 VDC	2857-401	4050821676966
			x		x					24 VDC	857-400	4045454471293
	x	x			x		x	x		24 VDC	857-401	4045454828509
± 10 mA ± 20 mA ±5 V ±10 V		x	x		x	x				24 VDC	857-402	4050821099772
± 10 mA ± 20 mA			x		x					24 VDC	857-409	4045454828493
±5 V ±10 V												
										24 VDC	857-411	4045454471224
											857-412	4045454471309
											857-413	4045454609870
											857-414	4045454609863
											857-415	4045454609856
											857-416	4045454609849

Technical Details








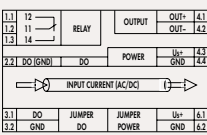

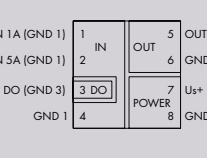

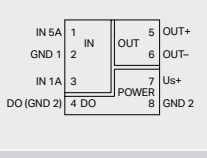

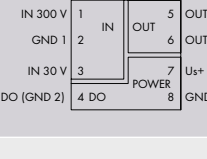

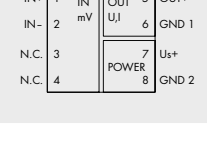
WAGO Signal Conditioners








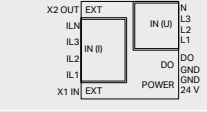

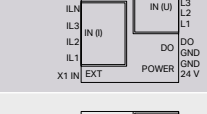

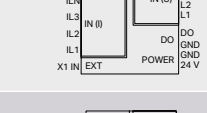

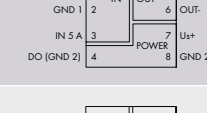

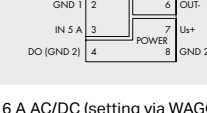
	Description	Image	Circuit Diagram	Input			Output	
	 Signal Conditioners							
Isolation Amplifier	Isolation Amplifier		 <p> $U_{\text{Sensor+}}$ 1 5 OUT+ IN 2 6 GND 2 GND 1 3 IN 7 $U_{\text{s+}}$ GND 1 4 POWER 8 GND 3 </p>	0 ... 20 mA 4 ... 20 mA			0 ... 20 mA 4 ... 20 mA	0 ... 5 V 1 ... 5 V 0 ... 10 V 2 ... 10 V
Signal Splitters	Signal Splitter; with current output		 <p> IN+ 1 5 OUT 1+ GND 1 2 IN 6 GND 2 OUT 2+ 3 OUT 2 7 $U_{\text{s+}}$ GND 4 4 POWER 8 GND 3 </p>	0 ... 20 mA 4 ... 20 mA	0 ... 5 V 1 ... 5 V 0 ... 10 V 2 ... 10 V		2 x 0(4) ... 20 mA	
	Signal Splitter; with voltage/current output		 <p> IN+ 1 5 OUT 1+ GND 2 2 IN 6 GND 3 OUT 2+ 3 OUT 2 7 $U_{\text{s+}}$ GND 4 4 POWER 8 GND 1 </p>	0 ... 10 mA 2 ... 10 mA 0 ... 20 mA 4 ... 20 mA	0 ... 5 V 1 ... 5 V 0 ... 10 V 2 ... 10 V		2 x 0 ... 20 mA 4 ... 20 mA	2 x 0 ... 10 V 2 ... 10 V
Passive Isolators	Loop-Powered Isolator		 <p> $U_{\text{+}}$ 1 5 $U_{\text{s+}}$ $U_{\text{-}}$ 2 6 OUT 1 IN U, I 3 7 N.C. I+ 3 N.C. 8 N.C. I- 4 8 N.C. </p>	0 ... 5 mA 0 ... 10 mA 2 ... 10 mA 0 ... 20 mA 4 ... 20 mA	0 ... 1 V 0 ... 5 V 1 ... 5 V 0 ... 10 V 2 ... 10 V	± 5 mA ± 10 mA ± 20 mA ± 1 V, ± 5 V ± 10 V ± 20 V	4 ... 20 mA	
	Passive Isolator; 1-channel		 <p> IN+ 1 5 OUT+ GND 1 2 IN 6 GND 2 N.C. 3 7 N.C. N.C. 4 8 N.C. </p>	0(4) ... 20 mA			0(4) ... 20 mA	
	Passive Isolator; 2-channel		 <p> IN 1+ 1 5 OUT 1+ GND 1 2 IN 1 6 GND 2 IN 2+ 3 IN 2 7 OUT 2+ GND 3 4 8 GND 4 </p>	2 x 0(4) ... 20 mA			2 x 0(4) ... 20 mA	

Special Functions					Configuration					Power Supply	Item No.	EAN No.
												
					x					24 VDC	857-420	4045454471330
					x					24 VDC	857-423	4045454471316
					x					24 VDC	857-424	4055143595476
			x		x					Power via output circuit	857-450	4045454828479
										Power via input circuit	857-451	4045454471323
										Power via input circuit	857-452	4045454471354

Technical Details

WAGO Current/Voltage Signal Conditioners and Power

	Description	Image	Circuit Diagram	Input			Output	
Current and Voltage Signal Conditioners	 Current and Voltage Signal Conditioners			  	 			
	Through-Hole Current Signal Conditioner			AC/DC 100 A			0 ... 10 mA 2 ... 10 mA 0 ... 20 mA 4 ... 20 mA	0 ... 5 V 1 ... 5 V 0 ... 10 V 2 ... 10 V
	Current Signal Conditioner			1 A AC/DC 5 A AC/DC (SELV)			0 ... 10 mA 2 ... 10 mA 0 ... 20 mA 4 ... 20 mA	0 ... 5 V 1 ... 5 V 0 ... 10 V 2 ... 10 V
	Current Signal Conditioner			1 A AC/DC 5 A AC/DC*			0 ... 10 mA 2 ... 10 mA 0 ... 20 mA 4 ... 20 mA	0 ... 5 V 1 ... 5 V 0 ... 10 V 2 ... 10 V
	Voltage Signal Conditioner			300 V AC/DC			0 ... 10 mA 2 ... 10 mA 0 ... 20 mA 4 ... 20 mA	0 ... 5 V 1 ... 5 V 0 ... 10 V 2 ... 10 V
	Millivolt Signal Conditioner				0 ... 200 mV 0 ... 1000 mV	±100 mV	0 ... 10 mA 2 ... 10 mA 0 ... 20 mA 4 ... 20 mA	0 ... 5 V 1 ... 5 V 0 ... 10 V 2 ... 10 V

	Description	Image	Circuit Diagram	Input			Output	
Power Measurement Modules	 Power Measurement Modules			  	 			
	3-Phase Power Measurement Module; 1 A; Modbus RTU			1 AAC	U_{LN} 400 VAC U_{LL} 690 VAC			
	3-Phase Power Measurement Module; 5 A; Modbus RTU			5 AAC	U_{LN} 400 VAC U_{LL} 690 VAC			
	3-Phase Power Measurement Module RC; Modbus RTU			22.5 mV/kA (Rogowski coil)	U_{LN} 400 VAC U_{LL} 690 VAC			
	Power Measurement Module			300 V AC/DC	5 V AC/DC		± 20 mA	±10 V
	Power Measurement Module			8 A AC/DC	500 V AC/DC		±24 mA	±12 V

*If a single unit is mounted, the new module can directly measure up to 6 A AC/DC (setting via WAGO Interface Configuration Software).








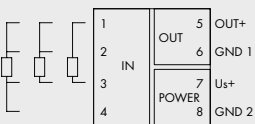

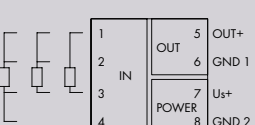

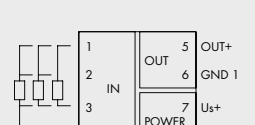

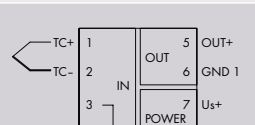

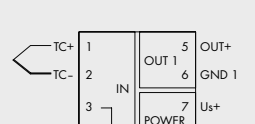

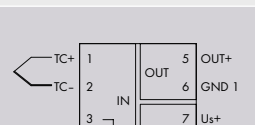

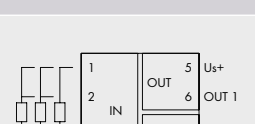
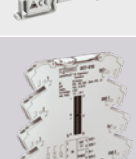
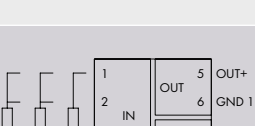
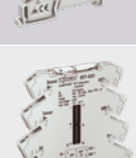
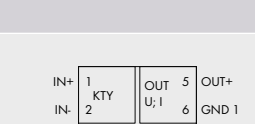
Power Measurement Modules

	Special Functions					Configuration				Power Supply	Item No.	EAN No.
±12 V ±24 mA	x	x	x	x	x	x	x	x	x	24 VDC	2857-550	4050821676997
	x	x				x	x	x		24 VDC	857-550	4050821226734
±10 V ± 20 mA	x	x				x	x			24 VDC	857-551	4050821476917
±10 V ± 20 mA	x	x				x	x	x		24 VDC	857-560	4055143481571
		x				x	x	x		24 VDC	857-819	4045454665975

	Special Functions					Configuration				Power Supply	Item No.	EAN No.
Modbus RTU	x						x			24 VDC	2857 - 570 / 024 - 001	4055143827539
Modbus RTU	x						x			24 VDC	2857 - 570 / 024 - 005	4055143827461
Modbus RTU	x						x			24 VDC	2857 - 570 / 024 - 000	4055143829199
	x	x			x		x	x		24 VDC	857-569	4055143501026
	x	x	x	x			x		x	24 VDC	2857-569	4055143907323

Technical Details

WAGO Temperature Signal Conditioners










Description		Image	Circuit Diagram	Input			Output	
 Temperature Signal Conditioners								
Temperature Signal Conditioners	Temperature Signal Conditioner; for Pt and resistance sensors			Pt100 Pt200 Pt500 Pt1000	0 ... 1 kΩ 0 ... 4.5 kΩ	2-wire 3-wire 4-wire	0 ... 10 mA 2 ... 10 mA 0 ... 20 mA 4 ... 20 mA	0 ... 5 V 1 ... 5 V 0 ... 10 V 2 ... 10 V
	Temperature Signal Conditioner; for Pt and resistance sensors			Pt100 Pt200 Pt500 Pt1000*	0 ... 1 kΩ 0 ... 4.5 kΩ	2-wire 3-wire 4-wire	0 ... 10 mA 2 ... 10 mA 0 ... 20 mA 4 ... 20 mA	0 ... 5 V 1 ... 5 V 0 ... 10 V 2 ... 10 V
	Temperature Signal Conditioner; for Pt46 and Cu53 sensors			Pt46 Cu53		2-wire 3-wire 4-wire	0 ... 10 mA 2 ... 10 mA 0 ... 20 mA 4 ... 20 mA	0 ... 5 V 1 ... 5 V 0 ... 10 V 2 ... 10 V
	Temperature Signal Conditioner; for thermocouples			Type J, K			0 ... 10 mA 2 ... 10 mA 0 ... 20 mA 4 ... 20 mA	0 ... 5 V 1 ... 5 V 0 ... 10 V 2 ... 10 V
	Temperature Signal Conditioner; for thermocouples			Type J, K, L, E, R, N, S, T, B, S*			0 ... 10 mA 2 ... 10 mA 0 ... 20 mA 4 ... 20 mA	0 ... 5 V 1 ... 5 V 0 ... 10 V 2 ... 10 V
	Temperature Signal Conditioner; for thermocouples			Type K, S, B, R			0 ... 10 mA 2 ... 10 mA 0 ... 20 mA 4 ... 20 mA	0 ... 5 V 1 ... 5 V 0 ... 10 V 2 ... 10 V
	Loop-Powered RTD Temperature Signal Conditioner			Pt100 Pt200 Pt500 Pt1000	0 ... 1 kΩ 0 ... 4.5 kΩ	2-wire 3-wire 4-wire	0 ... 10 mA 2 ... 10 mA 0 ... 20 mA 4 ... 20 mA	0 ... 5 V 1 ... 5 V 0 ... 10 V 2 ... 10 V
	Temperature Signal Conditioner; for Ni sensors			Ni100 Ni120 Ni200 Ni500 Ni1000		2-wire 3-wire 4-wire	0 ... 10 mA 2 ... 10 mA 0 ... 20 mA 4 ... 20 mA	0 ... 5 V 1 ... 5 V 0 ... 10 V 2 ... 10 V
	Temperature Signal Conditioner; for KTY sensors			KTY sensors		2-wire	0 ... 10 mA 2 ... 10 mA 0 ... 20 mA 4 ... 20 mA	0 ... 5 V 1 ... 5 V 0 ... 10 V 2 ... 10 V









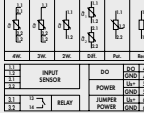

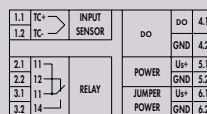

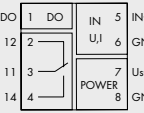
*Additional settings via interface configuration software








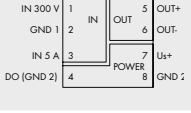
Special Functions					Configuration					Power Supply	Item No.	EAN No.
												
		x			x					24 VDC	857-800	4045454470128
		x			x		x	x		24 VDC	857-801	4045454502713
					x					24 VDC	857-808	4050821468929
		x			x					24 VDC	857-810	4045454470135
		x			x		x	x		24 VDC	857-811	4045454502751
					x					24 VDC	857-812	4050821255291
					x					Power via output circuit	857-815	4055143475648
		x			x					24 VDC	857-818	4050821099789
	x	x			x					24 VDC	857-820	4050821053002








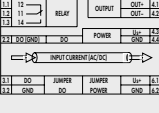
Technical Details









WAGO Threshold Value Switches












	Description	Image	Circuit Diagram	Input	Output	
Temperature Signal Conditioners	 Temperature Signal Conditioners				  	
	RTD/TC Temperature Signal Conditioner; analog			RTD sensors Potentiometers Resistors Thermocouples	2-wire 3-wire 4-wire Differential measurement Potentiometers	-24 ... +24 mA (load impedance ≤ 600 Ω) -12 ... +12 V (load impedance ≥ 2 kΩ)
	RTD/TC Temperature Signal Conditioner; serial					Modbus RTU












	Description	Image	Circuit Diagram	Input	Output	
Threshold Value Switches	 Threshold Value Switches			     		
	RTD Threshold Value Switch				2-wire 3-wire 4-wire	Potentiometers 0 ... 100 kΩ
	Thermocouple Threshold Value Switch					
	Analog Threshold Value Switch			0 ... 10 mA 2 ... 10 mA 0 ... 20 mA 4 ... 20 mA	0 ... 5 V 1 ... 5 V 0 ... 10 V 2 ... 10 V 0 ... 15 V 0 ... 30 V	± 10 mA ± 20 mA ± 5 V ± 10 V












	Description	Image	Circuit Diagram	Input	Output
Power Measurement Module	 Power Measurement Module			  	 
	Power Measurement Module			8 A AC/DC	500 V AC/DC

	Description	Image	Circuit Diagram	Input	Output
Current Signal Conditioner	 Current Signal Conditioner			  	 
	Through-Hole Current Signal Conditioner			100 A AC/DC	

Special Functions			Configuration				Power Supply	Item No.	EAN No.
									
1 change-over contact (1 u) 250 VAC / 6 A	X	X	X	X	X		9.6 ... 31.2 VDC	2857-535	4055143655507
		X	X	X	X	X		2857-535/ 000-001	4055143655514

	Special Functions				Configuration					Power Supply	Item No.	EAN No.	
													
Pt100 Pt200 Pt500 Pt1000 Pt5000, Pt10,000 Pt10 ... 20,000	250 VAC 6 A		X	X	X		X	X	X	24 VDC	2857-533	4050821676973	
Type J, K, E, N, R, S, T, B, C		250 VAC 6 A		X	X	X		X	X	X	24 VDC	2857-534	4055143242318
		250 VAC 6 A		X		X	X	X	X		24 VDC	857-531	4045454885229

	Special Functions				Configuration					Power Supply	Item No.	EAN No.
												
	X	X	X	X			X		X	24 VDC	2857-569	4055143907323

	Special Functions				Configuration					Power Supply	Item No.	EAN No.
												
± 10 mA ± 20 mA ±5 V ±10 V	X	X	X	X	X	X	X	X	X	24 VDC	2857-550	4050821676997

WAGO Accessories

Software		Item No.	EAN No.	
	Interface Configuration Software Configuration and display tool for PC	Download from www.wago.com/configuration-software	–	
	JUMPFLEX®-ToGo Smartphone App Configuration and display tool for smartphones (Android)	Download from Google Play Store	–	
	WAGO USB Service Cable Connects a PC (notebook) to the 857 Series Signal Conditioner's service interface	750-923 (2.5 m long) 750-923/000-001 (5 m long)	4045454571641 4045454765200	
	WAGO Bluetooth® Adapter Connects a PC (notebook) to the 857 Series Signal Conditioner's service interface	750-921	4044918368100	
Push-In Type Jumper Bars		Item No.	EAN No.	
	Push-In Type Jumper Bar; light gray; insulated; 18 A	2-way	859-402	4044918506434
		3-way	859-403	4044918507240
		4-way	859-404	4044918507820
		5-way	859-405	4044918508155
		6-way	859-406	4044918508278
		7-way	859-407	4044918508339
		8-way	859-408	4044918508513
		9-way	859-409	4044918508421
		10-way	859-410	4044918508513
		Item no. suffixes for colored push-in type jumper bars	yellow red blue	... /000-029 ... /000-005 ... /000-006
	Comb-Style Jumper Bar Only suitable for 857 Series	2-way	281-482	4044918523042
Wiring		Item No.	EAN No.	
	Interface Adapter for System Wiring	857-980	4045454995164	
	Supply and Through Module	857-979	4050821088189	
	WAGO Interface Cable, 16-pole/free end; 2 m long	706-100/1602-200	4050821452447	

Current Transformers, Rogowski Coils and Power Supplies		Item No.	EAN No.
	Current Transformers Primary current: 50 ... 2500 A Secondary current: 1 A and 5 A (other values upon request or at www.wago.com)	855 Series	–
	Rogowski Coils Primary current up to 4000 A	855 Series	–
	Switched-Mode Power Supply in 22.5 mm wide 2857 Series housing; shares a common profile with the 2857 and 857 Series Signal Conditioners; Output current: 1 A	787-2852	4055143060554
	Power Supply in the signal conditioner housing; Output voltage: 1.25 A	787-2850	–
Relay		Item No.	EAN No.
	Relay with 1 Changeover Contact 24 VDC / 250 V / 6 A	857-359	4050821797807
Marking		Item No.	EAN No.
	WMB Multi Marking System TOPJOB® S Marking System	793 Series 2009-110	4044918102483
Other Accessories		Item No.	EAN No.
	Operating Tool with a partially insulated shaft; Type 2; 3.5 x 0.5 mm blade	210-720	4045454937393
	End Stops	249-116 (6 mm wide) 249-117 (10 mm wide) 249-197 (14 mm wide)	4017332270823 4017332270830 4050821517535
	Test Pin	735-500	4050821226932
	DC/DC CONVERTERS	787-2801 (5 VDC) 787-2802 (10 VDC) 787-2803 (24 VDC) 787-2805 (12 VDC) 787-2810 (5/10/12 VDC, configurable)	–



WAGO Current and Energy Measurement Technology

Product Overview

Never before has the demand for systematic energy management been greater, because it can significantly reduce escalating energy costs. The use of standardized and cost-effective automation technology is simplifying what was previously an exhausting puzzle consisting of highly varied technological components. Many energy management projects show that energy savings of 30% or more are possible, depending on operations.

When this type of project is started, however, only the total energy costs are initially known. There is a lack of detailed information about the amount of energy used at specific points, and exactly where energy can be saved. Therefore, improvement processes begin with the systematic recording, analysis and evaluation of an organization's energy consumption.



WAGO I/O System, 750 Series

3-Phase Power Measurement Modules measure voltage and current, as well as power and energy consumption in three-phase networks.

3-Phase Power Measurement Modules, 2857 Series

With the 3-Phase Power Measurement Module in a DIN-rail-mount enclosure, WAGO offers the ideal solution to remotely measure currents and voltages in a three-phase supply network from the control level.

Current/Voltage Signal Conditioners and Power Measurement Modules, 857 and 2857 Series

Measure DC and AC currents or DC and AC voltages.

Voltage Taps, 855 Series

Safely tap the measurement voltage.

- For insulated conductors
- For busbars

Current and Voltage Taps, 855 Series

Combining a current transformer and voltage tap, this ingenious solution can be quickly and easily mounted into the jumper slot of WAGO's 2-Conductor Through Terminal Blocks (285 Series).

Current Transformers, 855 Series

Convert AC currents.

- Plug-In Current Transformers with CAGE CLAMP®
- Plug-In Current Transformers with a *picoMAX*® Pluggable Connector
- Split-Core Current Transformers

Rogowski Coils, 855 Series

Convert AC currents up to 4000 A.

WAGO Energy Data Management – The Right Solution for Every Step

With Our State-of-the-Art Energy Data Collection

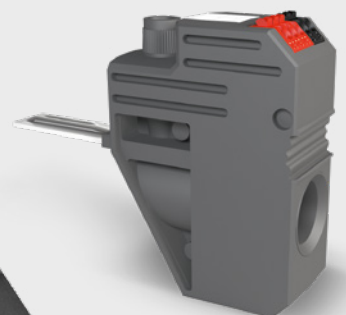
Transparency Pays Off

Synchronized electricity and energy measurement solutions enable the comprehensive recording of consumption data to create a basis for determining relevant efficiency ratios. This transparency is essential for discovering potential savings and, with appropriate measures, trimming costs considerably. This is also particularly important for large-scale consumers, such as the press line or body construction in an auto plant.

Measuring – Systematically Record Energy Consumption

Anywhere high currents must be measured and processed, plug-in current transformers are always the first choice. If existing systems need to be retrofitted, save time by using Rogowski coils to avoid disassembling cables or interrupting processes.

CONVERTING





Cloud Connectivity (via MQTT)



PARAMETER SETTING VISUALIZING



EVALUATING

Evaluating – Identify and Plan Energy Use

Three standard operation 3-Phase Power Measurement Modules within the WAGO I/O System 750 are available for recording and evaluating all relevant metrics from a three-phase supply network. A variant engineered for extreme conditions (XTR) and harsh applications is also available. This allows comprehensive network analysis to be performed and the power supply for machine drives to be controlled optimally, helping prevent damage, machine failure and downtime.

Parameterization and Visualization

Software solutions for the WAGO I/O System and WAGO's Signal Conditioners make parameterization and visualization simple with the new WAGO Energy Data Management Application.

Cloud Connectivity

The MQTT software extension for the PFC100 and PFC200 Controllers allows data to be easily transmitted from the field level to the cloud. You can decide whether the controller sends the data to Microsoft Azure, Amazon Web Services or IBM Bluemix.

MEASURING

Selection Guide: Current Transformers

The Right Solution for Every Application

Current Transformers, 855 Series	Split-Core Current Transformers	Plug-In Current Transformers with CAGE CLAMP® Connection Technology
		
Application	Retrofits	New systems
Coil bobbin	Separable	Closed
Connection technology	Connection cable (color coded)	CAGE CLAMP®
Mounting	Round cable (insulated), copper current bar (insulated)	Round cable, copper current bar, DIN-rail, mounting plate
Compatibility with other WAGO components	750-493, (750-493/000-001) 750-494, (750-494/000-001) 750-495, (750-495/000-001) 857-550, 2857-570/024-001 2857-570/024-005	
Primary rated current	60 ... 1000 A	50 ... 2500 A
Secondary rated current	1 A / 5 A	1 A / 5 A
Accuracy class	0.5; 1 or 3	1 or 3
Surrounding air temperature	-10 ... +55 °C	-5 ... +50 °C
Standards	EN 61869-2	EN 61869-2
Approvals	-	
Connection examples		

*In the measurement range from 0.8 A to 32 A and in combination with WAGO's 3-Phase Power Measurement Modules, the accuracy class 0.5 is met per EN 61869-2.

Plug-In Current Transformers with a <i>picoMAX</i> ® Pluggable Connector		Current and Voltage Taps	Rogowski Coils RC 70 / RC 125 / RC 175
			
New systems		New systems	Retrofits
Closed		Closed	Bayonet connector, separable
picoMAX®		Push-in CAGE CLAMP®	Connection cable
Round cable, DIN-rail, mounting plate		Jumper slot of the 285 Series 2-Conductor Through Terminal Blocks 285-150, 285-195, 285-1185, 285-141, 285- 181, 285-1161	Round cable, copper current bar
750-493,750-494 750-495, 857-550, 2857-570/024-001		750-493 750-494 750-495 857-550 2857-570/024-001	750-495/000-002 857-552 2857-570/024-000
32 A	35 / 64 A	150 ... 350 A	Up to 4000 A
320 mA	1 A	1 A	22.5 mV / kA
0.5*	1	0.5	0.5
-10 ... +55 °C		-25 ... +70 °C	-40 ... +80 °C
EN 61869-2		EN 61869-2, EN 60947-7-3, IEC 60068-2-6	IEC 61010-1 / EN 61869-2
–		–	UL listed
			

WAGO Plug-In Current Transformers

With CAGE CLAMP® Connection Technology

Image	Primary Rated Current	Secondary Rated Current	Rated Power	Accuracy Class	Item No.	EAN No.
 <p>Current bar 1: 30 x 10 mm Current bar 2: 25 x 12 mm Current bar 3: 20 x 20 mm Round cable: 26 mm</p>	50 A	1 A	1.25 VA	3	855-301/050-103	4050821614654
	50 A	5 A	1.25 VA	3	855-305/050-103	4050821749301
	60 A	1 A	1.25 VA	1	855-301/060-101	4050821616856
	60 A	5 A	1.25 VA	1	855-305/060-101	4050821749318
	75 A	1 A	2.5 VA	1	855-301/075-201	4050821616863
	75 A	5 A	2.5 VA	1	855-305/075-201	4050821749325
	100 A	1 A	2.5 VA	1	855-301/100-201	4050821616870
	100 A	5 A	2.5 VA	1	855-305/100-201	4050821749332
	150 A	1 A	5 VA	1	855-301/150-501	4050821616887
	150 A	5 A	5 VA	1	855-305/150-501	4050821749349
	200 A	1 A	5 VA	1	855-301/200-501	4050821616894
	200 A	5 A	5 VA	1	855-305/200-501	4050821749356
	250 A	1 A	5 VA	1	855-301/250-501	4050821616900
	250 A	5 A	5 VA	1	855-305/250-501	4050821616900
	300 A	5 A	5 VA	1	855-305/300-501	4055143389174
	400 A	1 A	10 VA	1	855-301/400-1001	4050821616917
400 A	5 A	10 VA	1	855-305/400-1001	4050821749387	
600 A	1 A	10 VA	1	855-301/600-1001	4050821616924	
600 A	5 A	10 VA	1	855-305/600-1001	4050821749400	
 <p>Current bar 1: 40 x 10 mm Current bar 2: 30 x 15 mm Round cable: 32 mm</p>	250 A	1 A	5 VA	1	855-401/250-501	4055143523226
	250 A	5 A	5 VA	1	855-405/250-501	4050821845706
	400 A	1 A	5 VA	1	855-401/400-501	4050821616931
	400 A	5 A	5 VA	1	855-405/400-501	4050821749370
	600 A	1 A	5 VA	1	855-401/600-501	4055143262521
	750 A	5 A	5 VA	1	855-405/750-501	4055143389181







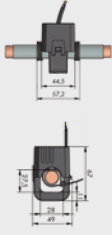
Accessories		Item No.	EAN No.
	DIN-Rail Adapter for Plug-In Current Transformers (for 855-3xx/xxxx-xxxx and 855-4xx/xxxx-xxxx)	855-9900	4050821627593
	Quick-Mount Kit (2 pieces, including cable tie)	855-9910	4050821749981

Image	Primary Rated Current	Secondary Rated Current	Rated Power	Accuracy Class	Item No.	EAN No.
 <p>Current bar 1: 50 x 12 mm Current bar 2: 40 x 30 mm Round cable: 44 mm</p>	400 A	1 A	10 VA	1	855-501/400-1001	4055143523233
	400 A	5 A	10 VA	1	855-505/400-1001	4050821845881
	600 A	1 A	10 VA	1	855-501/600-1001	4055143523240
	600 A	5 A	10 VA	1	855-505/600-1001	4050821845737
	800 A	1 A	10 VA	1	855-501/800-1001	4055143523257
	800 A	5 A	10 VA	1	855-505/800-1001	4050821845744
	1000 A	1 A	10 VA	1	855-501/1000-1001	4050821616948
	1000 A	5 A	10 VA	1	855-505/1000-1001	4050821749417
 <p>Busbar 1: 63 x 10 mm Busbar 2: 50 x 30 mm Round cable: 44 mm</p>	1500 A	1 A	5 VA	1	855-601/1500-501	4055143262538
	1500 A	5 A	5 VA	1	855-605/1500-501	4055143263009
 <p>Current bar 1: 80 x 10 mm Current bar 2: 60 x 30 mm Round cable: 55 mm</p>	1000 A	1 A	10 VA	1	855-801/1000-1001	4055143523264
	2000 A	1 A	10 VA	1	855-801/2000-1001	4055143262996
	2000 A	5 A	10 VA	1	855-805/2000-1001	4055143262989
 <p>Current bar 1: 100 x 10 mm Current bar 2: 80 x 30 mm Round cable: 70 mm</p>	2500 A	1 A	10 VA	1	855-1001/2500-1001	4055143262972
	2500 A	5 A	10 VA	1	855-1005/2500-1001	4055143262965

WAGO Split-Core Current Transformers



Retrofit Existing Systems

Image	Primary Rated Current	Secondary Rated Current	Rated Power	Accuracy Class	Cable Length	Item No.	EAN No.
Ø 18 mm							
	60 A	1 A	0.2 VA	3	3 m	855-3001/060-003	4050821880554
	75 A	1 A	0.2 VA	3	3 m	855-3001/075-003	4050821880561
	100 A	1 A	0.2 VA	3	3 m	855-3001/100-003	–
	125 A	1 A	0.2 VA	3	3 m	855-3001/125-003	–
	150 A	1 A	0.2 VA	3	3 m	855-3001/150-003	–
	200 A	1 A	0.2 VA	1	3 m	855-3001/200-001	4050821880677
	250 A	1 A	0.2 VA	1	3 m	855-3001/250-001	4050821880684
Ø 18 mm							
	100 A	1 A	0.2 VA	1	3 m	855-4001/100-001	4050821880578
	125 A	1 A	0.2 VA	1	3 m	855-4001/125-001	–
	150 A	1 A	0.2 VA	1	3 m	855-4001/150-001	4050821880585
	200 A	1 A	0.2 VA	0.5	3 m	855-4001/200-001	4050821880592
	250 A	1 A	0.2 VA	0.5	3 m	855-4001/250-000	–
	150 A	5 A	1 VA	1	0.5 m	855-4005/150-101	4055143056342
	200 A	5 A	1 VA	1	0.5 m	855-4005/200-101	–
	250 A	5 A	1 VA	0.5	0.5 m	855-4005/250-100	–
Ø 42 mm							
	250 A	1 A	0.5 VA	1	5 m	855-5001/250-001	4055143163064
	300 A	1 A	0.5 VA	1	5 m	855-5001/300-001	–
	400 A	1 A	0.5 VA	0.5	5 m	855-5001/400-000	4050821880653
	500 A	1 A	0.5 VA	0.5	5 m	855-5001/500-000	–
	600 A	1 A	0.5 VA	0.5	5 m	855-5001/600-000	4050821880646
	750 A	1 A	0.5 VA	0.5	5 m	855-5001/750-000	–
	800 A	1 A	0.5 VA	0.5	5 m	855-5001/800-000	–
	1000 A	1 A	0.5 VA	0.5	5 m	855-5001/1000-000	4050821880639
	300 A	5 A	0.5 VA	1	3 m	855-5005/300-001	–
	400 A	5 A	0.5 VA	1	3 m	855-5005/400-001	4055143056373
	500 A	5 A	0.5 VA	1	3 m	855-5005/500-001	–
	600 A	5 A	0.5 VA	0.5	3 m	855-5005/600-000	4055143056380
	750 A	5 A	0.5 VA	0.5	3 m	855-5005/750-001	–
	800 A	5 A	0.5 VA	0.5	3 m	855-5005/800-001	–
	1000 A	5 A	0.5 VA	0.5	3 m	855-5005/1000-000	4055143056397
2 x Ø 42 mm							
	250 A	1 A	0.5 VA	1	5 m	855-5101/250-001	–
	300 A	1 A	0.5 VA	1	5 m	855-5101/300-001	–
	400 A	1 A	0.5 VA	0.5	5 m	855-5101/400-000	–
	500 A	1 A	0.5 VA	0.5	5 m	855-5101/500-000	–
	600 A	1 A	0.5 VA	0.5	5 m	855-5101/600-000	–
	750 A	1 A	0.5 VA	0.5	5 m	855-5101/750-000	–
	800 A	1 A	0.5 VA	0.5	5 m	855-5101/800-000	–
	1000 A	1 A	0.5 VA	0.5	5 m	855-5101/1000-000	4050821880660
	300 A	5 A	0.5 VA	1	3 m	855-5105/300-001	–
	400 A	5 A	0.5 VA	1	3 m	855-5105/400-001	–
	500 A	5 A	0.5 VA	1	3 m	855-5105/500-001	–
	600 A	5 A	0.5 VA	0.5	3 m	855-5105/600-000	–
	750 A	5 A	0.5 VA	0.5	3 m	855-5105/750-000	–
	800 A	5 A	0.5 VA	0.5	3 m	855-5105/800-000	–
	1000 A	5 A	0.5 VA	0.5	3 m	855-5105/1000-000	4055143056403

Image	Primary Rated Current	Secondary Rated Current	Rated Power	Accuracy Class	Cable Length	Item No.	EAN No.
Ø 28 mm							
	200 A	1 A	0.2 VA	1	3 m	855-4101/200-001	4050821880608
	250 A	1 A	0.2 VA	1	3 m	855-4101/250-001	4050821880615
	300 A	1 A	0.2 VA	1	3 m	855-4101/300-001	–
	400 A	1 A	0.2 VA	1	3 m	855-4101/400-001	4050821880622
	500 A	1 A	0.2 VA	0.5	3 m	855-4101/500-000	–
	250 A	5 A	1 VA	1	0.5 m	855-4105/250-101	4055143056359
	300 A	5 A	1 VA	1	0.5 m	855-4105/300-101	–
	400 A	5 A	1 VA	1	0.5 m	855-4105/400-101	4055143056366
	500 A	5 A	1 VA	1	0.5 m	855-4105/500-101	–

WAGO Plug-In Current Transformers

With a *picoMAX*® Pluggable Connector




Image	Primary Rated Current	Secondary Rated Current	Rated Power	Accuracy Class	Conductor Feed-through	Item No.	EAN No.
	35 A	1 A	0.2 VA	1	Ø 7.5 mm	855-2701/035-001	4050821864240
	64 A	1 A	0.2 VA	1	Ø 7.5 mm	855-2701/064-001	4050821864189
	DIN-Rail Adapter					855-9927	4050821866381
	32 A*	320 mA	0.1 Ω	0.5**	Ø 5.0 mm	855-1700/032-000	4055143333436

*In the measurement range between 0.8 and 32 A and in combination with WAGO's 3-Phase Power Measurement Modules (750-493/-494/-495), the accuracy class 0.5 is met per EN 61869-2.

**Testing adheres to EN 61869-2 with a conversion ratio of 16 A/0.16 A (accuracy class: 0.5) and an extended primary current of 200%.

WAGO Rogowski Coils

For Quickly and Easily Retrofitting Existing Systems

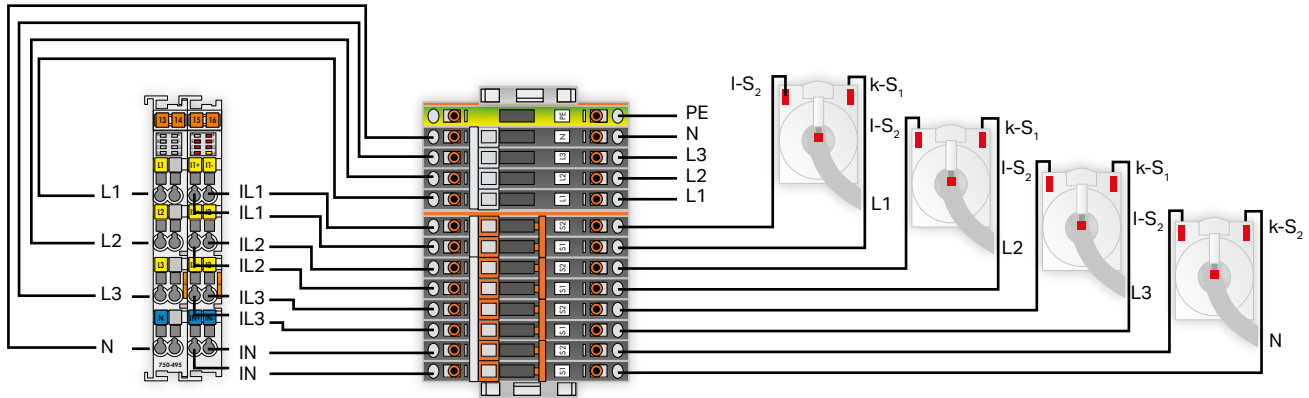
Image	Cable Length	Feedthrough for Measurement Conductor	Primary Rated Current*	Output Signal	Accuracy Class**	Item No.	EAN No.
	1.5 m	Ø 70 mm	4000 AAC	22.5 mV / kA at 50 Hz	1	855-9150/2000-0701	4055143419185
	4.5 m					855-9450/2000-0701	4055143419239
	1.5 m	Ø 125 mm	4000 AAC	22.5 mV / kA at 50 Hz	1	855-9150/2000-1251	4055143419208
	4.5 m					855-9450/2000-1251	4055143419215
	1.5 m	Ø 175 mm	4000 AAC	22.5 mV / kA at 50 Hz	1	855-9150/2000-1751	4055143419192
	4.5 m					855-9450/2000-1751	4055143419222

*The specifications for the primary rated current refer to a combination with the WAGO Modules (857-552 and 750-495/000-002). Rogowski technology allows the coils to measure a wide primary current range of up to 10,000 A without loss of accuracy, because there are no saturation effects.

**Per EN 61869-2

WAGO Terminal Block Assemblies for Current and Voltage Transformers

For Fast and Easy Connections



3-Phase Power Measurement Module, 750 Series

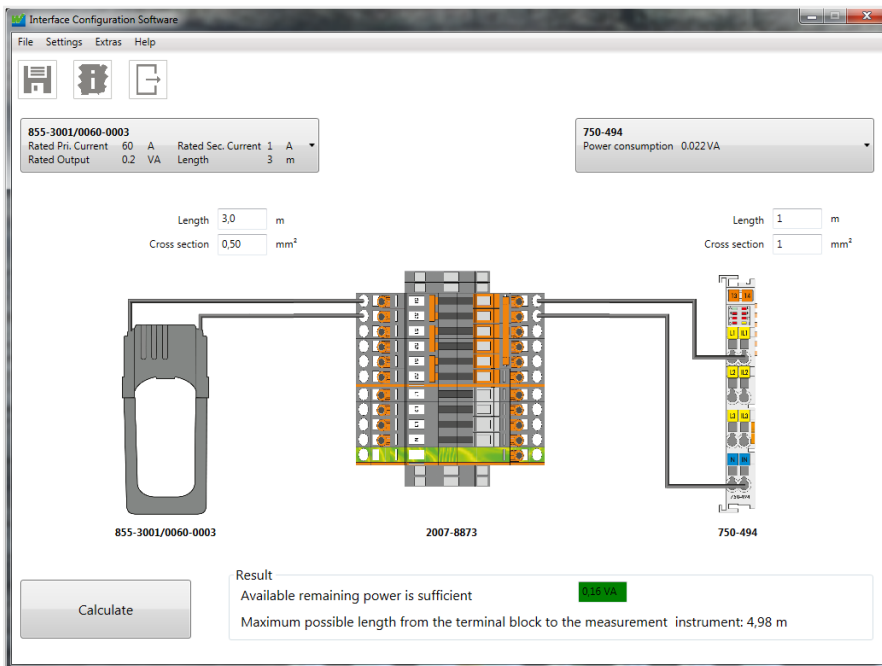
Terminal Block Assembly (2007 Series) for Current and Voltage Transformers

Current Transformers, 855 Series

Your benefits:

- Star point jumper
- Easy and clear wiring
- Short-circuiting of current transformers
- Test sockets for control measurements

Image	Rated Voltage	Nominal Current	Conductor Cross-Section	Item No.	EAN No.
	500 V	30 A	6 mm ²	2007-8873	4050821776697
				2007-8874	4055143070294
				2007-8875	4055143240628
				2007-8876	4050821771678
				2007-8877	4055143240673



Cable length calculation using the interface configuration software

Configuration report	
Project	WAGO
Project number	1582.23.58877
Company	Wago Kontakttechnik GmbH & Co. KG
Author	Michael Meyer
Date	21.08.2015
Stamp	
Transducer	
Item number	855-3001/0060-0003
Rated Pri. Current	60A
Rated Sec. Current	1A
Rated Output	0,221VA
Measurement instrument	
Item number	750-494
Power consumption	0,022VA
Cable from transducer to terminal block	
Length	3m
Cross section	0,5mm²
Power loss	0,021VA
Cable from terminal block to measurement instrument	
Length	1m
Cross section	1mm²
Power loss	0,036VA
Result	
Available power	0,221VA
Total power loss	0,057VA
Remaining power	0,164VA
Required power	0,022VA
Result	Available remaining power is sufficient

Easy documentation!

Power calculation of copper cables between measurement device and current transformer

$$P_V = \frac{I_s^2 \times 2 \times l}{A_{Cu} \times 56} \text{ VA}$$

- I_s = Secondary rated current strength [A]
- l = Simple cable length in m
- A_{Cu} = Cable cross-section in mm²
- P_V = Power loss of connection cables

Note: When a common three-phase return line is used, the values for P_V are halved!

Current transformer, 5 A

$$P_V = \frac{5^2 \times 2 \times 10}{1,5 \times 56} = 5.96 \text{ VA}$$

Current transformer, 1 A

$$P_V = \frac{1^2 \times 2 \times 10}{1,5 \times 56} \text{ VA} = 0.24 \text{ VA}$$

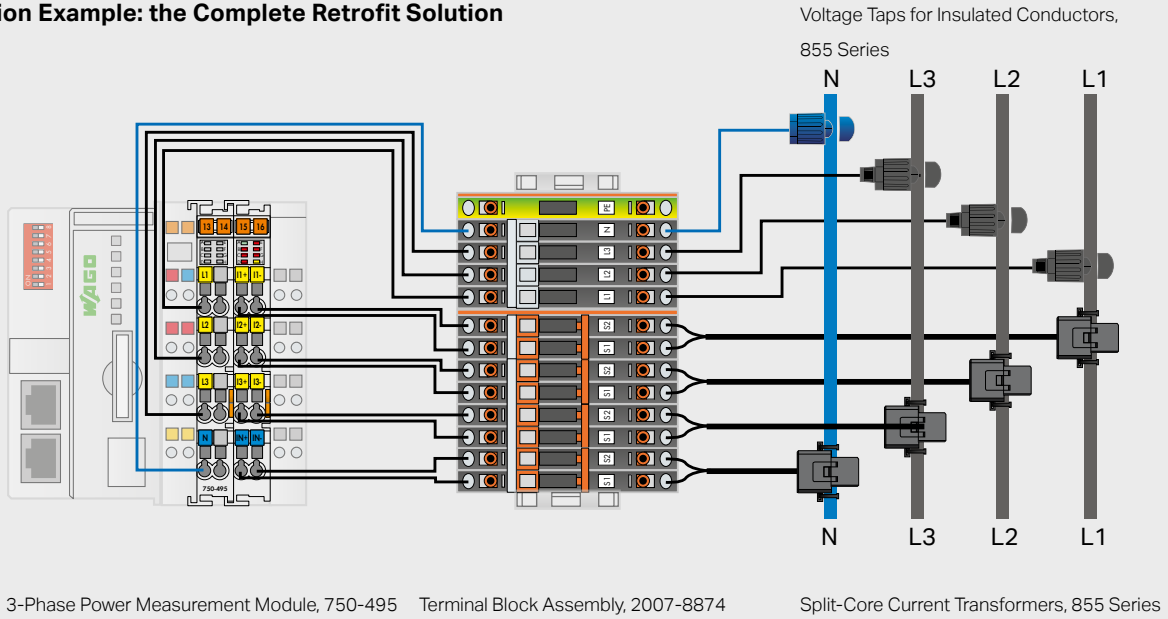
Example:

A 1 amp or 5 amp current transformer is used, with an ammeter on the secondary circuit, at a distance of 10 m between the transformer and the measurement device.

Free software download at:

www.wago.com/configuration-software

Application Example: the Complete Retrofit Solution



WAGO Voltage Taps

For Insulated Conductors



Installation on insulated conductor with IDC connection



Integrated SIBA fuse to protect equipment and conductor

Your benefits:

- Faster measurement voltage tapping with just one turn
- Tool-free assembly
- Conductor contact via IDC connection
- Reliable protection of measurement device and conductor via integrated SIBA fuse

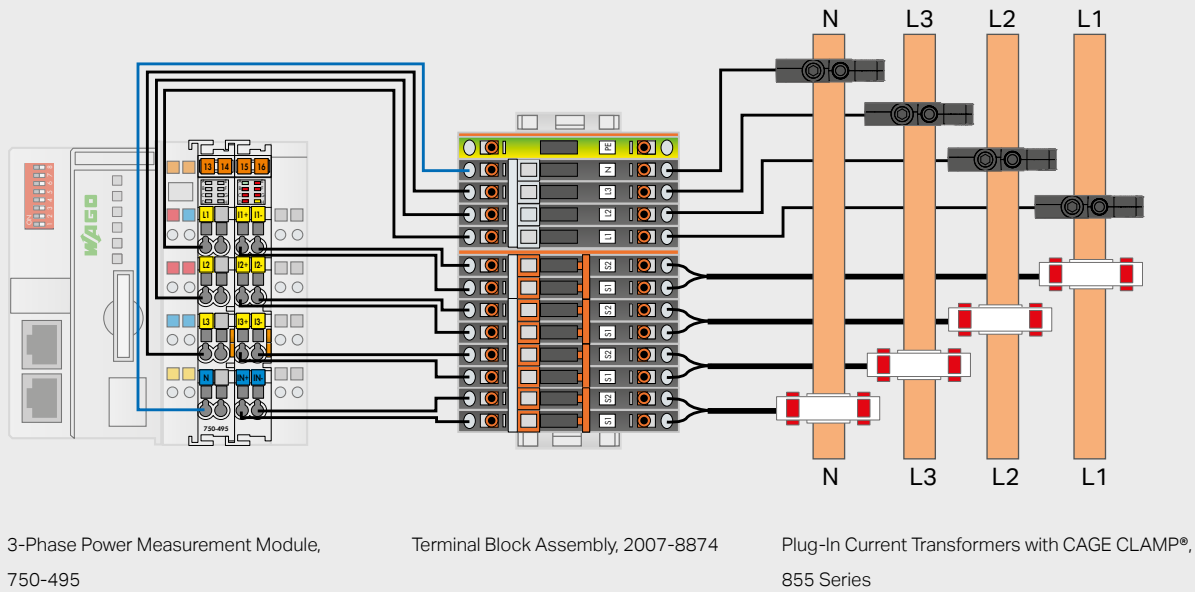


Watch the video to learn more

Image	Conductor Cross-Section	Fuse	Cable Length	Mounting	Item No.	EAN No.
	2.5 ... 6 mm ² (14 ... 10 AWG) Ø 3 ... 5 mm (Feedthrough for measurement conductor)	2 A, 450 V, F, 70 kA (5 x 25 mm)	3 m (pre-assembled)	Conductor contact via IDC connection	855-8001	4055143371780
		–			855-8002	4055143378857
	10 ... 16 mm ² (8 ... 6 AWG) Ø 5 ... 7 mm (feedthrough for measurement conductor)	2 A, 450 V, F, 70 kA (5 x 25 mm)			855-8003	4055143371797
		–			855-8004	4055143378840

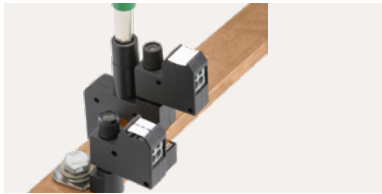
Application Example: The Complete Retrofit Solution

Voltage Taps, 855 Series



WAGO Voltage Taps

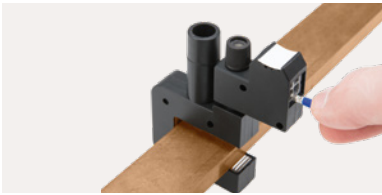
For Busbars



Installation on busbar; fastening with Allen wrench



Integrated SIBA fuse (overload and short circuit protection)



Push-in CAGE CLAMP® connection technology



Various marking options for clear identification

Your benefits:

- Fast, easy installation on a live busbar with clamp mount or M6/M8 mount
- Various marking options for clear identification
- Universal conductor termination via Push-in CAGE CLAMP® connection technology
- Fused voltage path protects downstream measurement devices

Image	Fuse	Connection Technology Solid/Fine-Stranded	Mounting	Item No.	EAN No.
			M6 mount	855-8006	4055143720038
	2 A, 450 V, F, 70 kA (5 x 25 mm)	Push-in CAGE CLAMP® (WAGO 2624 Series)	M8 mount	855-8008	4055143720052
			Clamp mount (4 ... 15 mm bar thickness)	855-8015	4055143720076

WAGO Current and Voltage Taps

The 2-in-1 Solution

Output – Voltage

- Redundant design

Output – Current

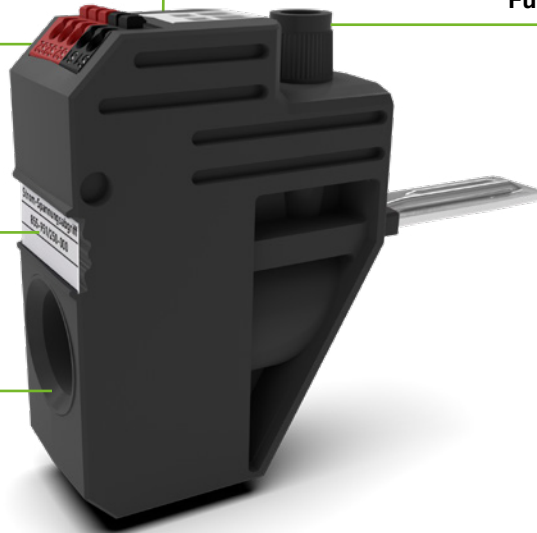
- Connecting the energy measurement device (1 A)
- Short-circuiting the current transformer
- Star point jumper

Marking Option

- TOPJOB® S Marking Strips
- WMB Multi Marking System

Feedthrough for Primary Conductors up to 50, 95 or 185 mm²

Fuse Protection



Your benefits:

- Power data can be directly tapped into the power supply
- Easy installation – simply insert the tap into the jumper slot of the 2-conductor through terminal block
- Integrated 25 A/1 A current transformer
- Complies with accuracy class 0.5 per EN 61869-2 for exact measurement results
- Fused voltage path protects downstream measurement devices



Technical Data

Product			
			
Item No.	855-501 / 150-000	855-951 / 250-000	855-1851 / 350-000
EAN No.	4055143782760	4055143556354	/
Feedthrough for measurement conductor	ø 12.0 mm	ø 16.0 mm	ø 21.5 mm
Primary rated current I_{pri}	150 A	250 A	350 A
Secondary rated current I_{sec}	1 A		
Accuracy class	0.5		
Rated voltage	400 VAC		
Fuse (voltage path)	F2 A, 450 V, 40 kA, 5 x 25 mm		
Operating temperature	-25 ... +70 °C		
Product standard	EN 61869-2, EN 60947-7-3, IEC 60068-2-6		
Suitable for 2-conductor through terminal blocks	50 mm ² (1/0 AWG)	95 mm ² (4/0 AWG)	185 mm ² (350 kcmil)
For DIN-rail mounting	285 - 150	285 - 195	285 - 1185
	285 - 154	285 - 194	285 - 1184
With mounting flanges	285 - 141	285 - 181	285 - 1161
	285 - 144	285 - 184	285 - 1164

WAGO Power and Energy Measurement



With the WAGO I/O System 750 and 750 XTR

WAGO's 3-Phase Power Measurement Modules measure and process all relevant metrics from a three-phase supply network. They provide system operators with greater

insight into energy consumption by specific machines and systems, as well as the ability to perform comprehensive network analysis.

Your benefits:

- Measure machine and system energy consumption values
- Detect and process all relevant metrics
- Comprehensive network analysis
- Connect to the fieldbus-independent, compact and flexible WAGO I/O System
- Compatible with the dark gray modules from the robust WAGO I/O System 750 XTR Series – perfect for monitoring harsh applications in eXTReme environments:
 - eXTReme temperatures: -40 to +70°C
 - eXTReme isolation up to 5 kV impulse voltage
 - eXTReme vibration resistance up to 5g acceleration

Item No.	750-493	750-494	750-495
Image			
EAN No.	4055143374385	4050821548232	4050821548256
Energy consumption	✓	✓	✓
Voltage	3~ 480 V	3~ 480 V	3~ 480 V/690 V
Current	1 A (750-493) 5 A (750-493/000-001)	1 A (750-494) 5 A (750-494/000-001) External Shunts (750-494/000-005)	1 A (750-495) 5 A (750-495/000-001) Rogowski Coil (750-495/000-002)
Active energy/power	✓	✓	✓
Phase position	✓	✓	✓
Reactive power/energy	via function block	✓	✓
Apparent power/energy	via function block	✓	✓
Rotary field detection		✓	✓
Power factor	(✓)	✓	✓
Frequency measurement	✓	✓	✓
Four-quadrant operation (inductive, capacitive, consumer, generator)		✓	✓
Harmonic analysis (up to the 41st harmonic)		✓	✓
Neutral conductor measurement			✓
Other product variants		Extended temperature range: -20 ... +60 °C (-4 ... 140 °F): 750-494/025-000 (1 A), 750-494/025-001 (5 A)	750 XTR: 750-495/040-000 (1 A), 750-495/040-001 (5 A), 750-495/040-002 (Rogowski Coil)
Housing width	12 mm	12 mm	24 mm



WAGO Power Supplies

Product Overview

WAGO Power Supply Pro 2

Applications with high output demands call for professional power supplies capable of handling power peaks reliably. WAGO's Pro 2 Power Supplies are ideal for such installations.

WAGO Power Supply Eco

Many basic applications only require 24 VDC. This is where WAGO's Eco Power Supplies excel as an economical solution.

WAGO Power Supply Classic

WAGO's Classic Power Supplies are exceptionally robust power supplies that offer optional TopBoost integration. Their wide input voltage range and an extensive list of international approvals allow them to be used in a wide variety of applications.

WAGO Power Supply Compact

WAGO's high-performance Compact Power Supplies in DIN-rail-mount housings are available with output voltages of 5, 12, 18 and 24 VDC, as well as nominal output currents up to 6.5 A.



Uninterruptible Power Supply (UPS)

Consisting of a 24 V UPS charger and controller with one or more connected battery modules, WAGO's Uninterruptible Power Supply reliably powers an application for several hours.

Redundancy Modules

WAGO's Redundancy Modules are ideal for reliably increasing power supply availability. These modules decouple two parallel-connected power supplies and are suitable for applications where an electrical load must be reliably supplied – even during a power supply failure.

Capacitive Buffer Modules

In addition to reliably ensuring trouble-free machine and system operation – even through brief power failures – WAGO's Capacitive Buffer Modules offer the power reserves that may be required for starting heavy motors or triggering a fuse.

Electronic Circuit Breakers (ECBs)

WAGO's compact ECBs provide reliable protection against overload and short circuit. Their slim design offers high channel density, saving valuable control cabinet space.

WAGO Power Supply Pro 2

PRO 2

Four persuasive benefits:

1. The combination of highly efficient power electronics and digital control provides savings on energy and operating costs, while cutting CO₂ emissions.
2. Their advanced ability to adapt to the powered application optimizes operation and reduces the risk of unscheduled downtimes.
3. Continuous communication via various fieldbus and IoT protocols allows seamless integration of the power supply – a must for Industry 4.0.
4. The power supply that provides control voltage to the control cabinet is simultaneously a sensor and actuator. As a sensor, it supplies data, such as output voltage and output current, in real time and also enables a virtual image of the application. As an actuator, it supplies the required power to the application at the right moment and prevents dangerous conditions, which increases the availability of the overall system.



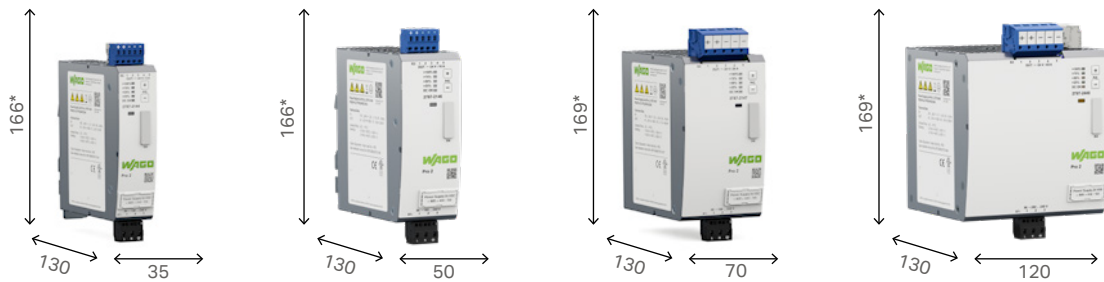
Class-Leading Product Features of the WAGO Power Supply Pro 2:

- Intelligent power management that supplies 150% power for 5 s, or up to 600% output power for 15 ms in the event of short circuits
- High level of resistance to adverse environmental influences: Heat, cold and elevation have little impact on performance
- Pioneering communication capabilities that keep you informed about all important status information and data – ready for Industry 4.0
- Easy planning and installation thanks to compact dimensions and 2D/3D data in the most important formats

Power supplies are the heart of a control cabinet’s DC power supply. Therefore, they must meet particularly strict requirements for reliability, efficiency and installation size. However, increasing networking and digitization also require new features, such as configuration options for adapting to the corresponding application and providing service and operating data, to implement the digital twin within a long-service application.

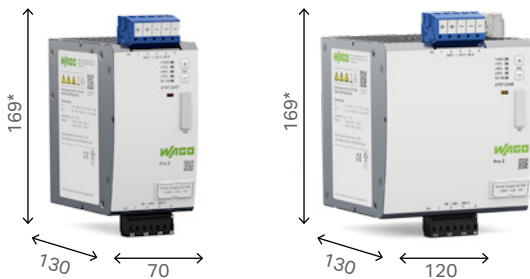
Our answer to these stricter requirements is the WAGO Power Supply Pro 2– the heart of the control cabinet, which transforms today’s challenges into tomorrow’s possibilities.

**1-Phase; Input: 90 ... 264 VAC or 180 ... 264 VAC (2787-2448)
24 VDC**



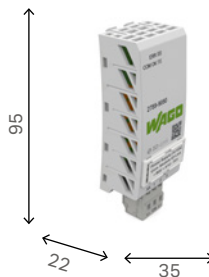
2787-2144	2787-2146	2787-2147	2787-2448
5 A	10 A	20 A	40 A

**3-Phase; Input: 340 ... 550 VAC
24 VDC**



2787-2347	2787-2348
20 A	40 A

IO-Link Communication Module



2789-9080

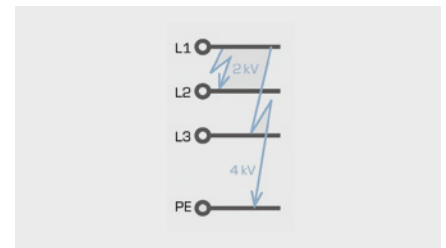
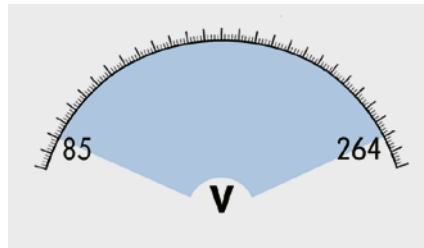
*with connectors – 130 mm without connectors

WAGO Power Supply Classic

787 Series

Image	Nominal Input Voltage	Nominal Output Voltage	Output Current	Efficiency	Dimensions (W x H x D in mm)*	Item No.	EAN No.
	1 x 100 ... 240 VAC	12 VDC	2 A	82 % (typ.)	22.5 x 107.5 x 90	787-1601	4055143060400
			4 A	86 % (typ.)	45 x 107.5 x 90	787-1611	4055143060448
			7 A	86 % (typ.)	52 x 121 x 90	787-1621	4055143060479
			15 A	90 % (typ.)	55 x 172 x 127	787-1631	4055143060509
	1 x 100 ... 240 VAC	24 VDC	1 A	86 % (typ.)	22.5 x 107.5 x 90	787-1602	4055143060417
			2 A	89 % (typ.)	45 x 107.5 x 90	787-1606	4055143060431
			4 A	89 % (typ.)	52 x 121 x 90	787-1616	4055143060455
			5 A	89 % (typ.)	42 x 137.5 x 127	787-1622	4055143060486
			10 A	91 % (typ.)	55 x 172 x 127	787-1632	4055143060516

*Height (H) from upper edge of the DIN-35 rail



Slim Design

- Save valuable cabinet space

Universal Supply

- Wide input voltage range
- Can be operated worldwide
- High level of operational reliability

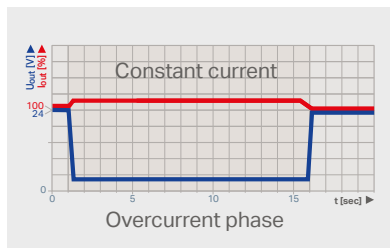
Increased Transient Suppression*

- Overvoltage-proof up to 2 kV (L-L) or 4 kV (L-PE)

*only for 787-1640 ... -1644

Image	Nominal Input Voltage	Nominal Output Voltage	Output Current	Efficiency	Dimensions (W x H x D in mm)*	Item No.	EAN No.
	1 x 100 ... 240 VAC	24 VDC	20 A	92 % (typ.)	95 x 177 x 127	787-1634	4055143060530
			3.8 A LPS / NEC Class 2	87 % (typ.)	52 x 121 x 90	787-1616/ 000-1000	4055143060462
	1 x 100 ... 240 VAC	48 VDC	2 A	86 % (typ.)	55 x 121 x 90	787-1623	4055143060493
			5 A	92 % (typ.)	55 x 172 x 127	787-1633	4055143060523
			10 A	93 % (typ.)	95 x 177 x 127	787-1635	4055143060547
	2 x 200 ... 500 VAC	24 VDC	5 A	89 % (typ.)	42 x 137 x 127	787-1628	4055143259156
			10 A		55 x 146.5 x 127	787-1638	4055143521420
	3 x 400 ... 500 VAC		10 A	90 % (typ.)	55 x 171 x 127	787-1640	4055143259163
			20 A	92 % (typ.)	80 x 178 x 127	787-1642	4055143259170
			40 A	92 % (typ.)	126 x 196 x 127	787-1644	4055143259187

*Height (H) from upper edge of the DIN-35 rail



Integrated TopBoost

- Reliably trigger the secondary-side fusing via miniature circuit breakers (≥ 120 W output power)
- Wire length calculator available at www.wago.com/wirelengthcalculation

High Load-Carrying Capacity

- Constant current characteristic under overload conditions
- 110% output current with lowered output voltage – even during a short circuit
- High capacitive loads can even be reliably started

Clear and Easy to Connect

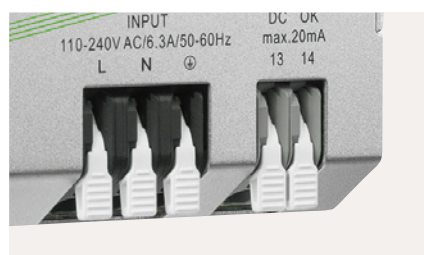
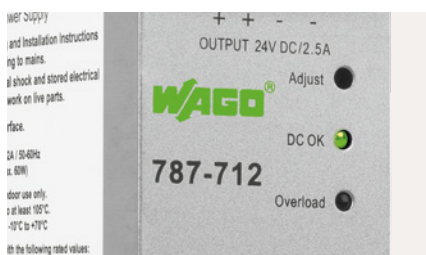
- CAGE CLAMP® connection technology – vibration-proof, fast, maintenance-free
- Colored and marked female connectors can be pre-assembled – 100% protected against mismatching

WAGO Power Supply Eco

787 Series

Image	Nominal Input Voltage	Nominal Output Voltage	Output Current	Efficiency	Dimensions (W x H x D in mm)*	Item No.	EAN No.	
	1 x 100 ... 240 VAC	12 VDC	2 A	86 % (typ.)	30 x 99 x 90	787-1701	4055143656023	
			4 A	87 % (typ.)	40 x 99 x 90	787-1711	4055143656030	
			8 A	86 % (typ.)	60 x 99 x 130	787-1721	4055143656047	
			24 VDC	1.25 A	86 % (typ.)	30 x 99 x 90	787-1702	4055143372459
				2.5 A	87 % (typ.)	40 x 99 x 90	787-1712	4055143372466
				5 A	86 % (typ.)	60 x 99 x 130	787-1722	4055143372442
	1 x 110 ... 240 VAC	24 VDC	2.5 A	86 % (typ.)	50 x 92 x 130	787-712	4045454908195	
			5 A	86 % (typ.)	75 x 92 x 130	787-722	4045454908188	
			10 A	86 % (typ.)	110 x 92 x 130	787-732	4045454908140	
			20 A	90 % (typ.)	115 x 144 x 130	787-734	4050821495291	
			40 A	90 % (typ.)	170 x 153 x 130	787-736	4050821748250	
	3 x (2 x) 400 VAC	24 VDC	6.25 A	87 % (typ.)	50 x 92 x 130	787-738	4050821847861	
			10 A	89 % (typ.)	65 x 130 x 130	787-740	4050821848370	
	3x (2 x) 400 ... 480 VAC	24 VDC	20 A	90.5 % (typ.)	80 x 170 x 140	787-2742	4055143588973	
			40 A	91.5 % (typ.)	140 x 170 x 140	787-2744	4055143588980	

*Height (H) from upper edge of the DIN-35 rail



Clear Indication

- Green LED indicates output voltage availability.
- Red LED indicates an overcurrent or short circuit.**
- Easy commissioning and maintenance

Fast Wiring

- Terminal strips with integrated levers (2706 or 2716 Series)***
- Convenient, tool-free wiring
- Integrated test slot simplifies testing by eliminating conductor removal

Easy Grounding

- Integrated third negative terminal on the output side***
- Direct connection to the reference ground, which is frequently used in machines and equipment

**787-7xx only

***787-734 ... -742 only

WAGO Power Supply Compact

CAGE CLAMP®









787 Series

Image	Nominal Input Voltage	Nominal Output Voltage	Output Current	Efficiency	Dimensions (W x H x D in mm)*	Item No.	EAN No.
	1 x 100 ... 240 VAC	5 VDC	5.5 A at 5 VDC	75 % (typ.)	72 x 55 x 89	787-1020	4055143098816
	1 x 100 ... 240 VAC	12 VDC	2 A at 12 VDC / 0.75 A at 18 VDC	80 % (typ.)	54 x 55 x 89	787-1001	4050821298236
			4 A at 12 VDC	85 % (typ.)	72 x 55 x 89	787-1011	4050821297604
			6.5 A at 12 VDC	87 % (typ.)	90 x 55 x 89	787-1021	4050821498018
	1 x 100 ... 240 VAC	18 VDC	2.5 A at 18 VDC / 2.3 A at 24 VDC; 55 W (max.)	83 % (typ.) at 18 VDC / 2.5 A; 85 % (typ.) at 24 VDC / 2.3 A	72 x 55 x 89	787-1017	4050821595731
	1 x 100 ... 240 VAC	24 VDC	1.3 A at 24 VDC	82 % (typ.)	54 x 55 x 89	787-1002	4050821298229
			2.5 A at 24 VDC	88 % (typ.)	72 x 55 x 89	787-1012	4050821297598
			4 A at 24 VDC	88 % (typ.)	90 x 55 x 89	787-1022	4050821297581
	100 ... 240 VAC	24 VDC	1.3 A	82 % (typ.)	54 x 55 x 89	787-1102	4055143421997
			2.5 A	88 % (typ.)	72 x 55 x 89	787-1112	4055143422000
			4 A	88 % (typ.)	90 x 55 x 89	787-1122	4055143422017
	85 ... 264 VAC	12 VDC	2.5 A	88.0 % (typ.)	54 x 90 x 56	787-1201	4055143863308
			5 A	89.0 % (typ.)	72 x 90 x 56	787-1211	4055143804226
			8 A	91.6 % (typ.)	108 x 90 x 56	787-1221	4055143863360

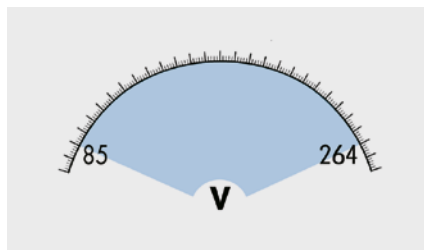
*Height (H) from upper edge of the DIN-35 rail

Compact Power Supply

787 Series

Image	Nominal Input Voltage	Nominal Output Voltage	Output Current	Efficiency	Dimensions (W x H x D in mm)*	Item No.	EAN No.
	100 ... 240 VAC	24 VDC	1.3 A	87 % (typ.)	54 x 55 x 90	787-1202	4055143415071
	100 ... 240 VAC	24 VDC	2.5 A	89 % (typ.)	72 x 55 x 90	787-1212	4055143415064
	100 ... 240 VAC	24 VDC	4.2 A	90 % (typ.)	108 x 55 x 90	787-1216	4055143415057
	100 ... 120 VAC 200 ... 240 VAC	24 VDC	6 A	90 % (typ.)	144 x 55 x 90	787-1226	4055143415040
	100 ... 240 VAC	24 VDC	0.5 A	83 % (typ.)	18 x 55 x 90	787-1200	–
	110 ... 240 VAC	24 VDC	1.25 A	88 % (typ.)	36 x 55 x 90	787-2850	–
	100 ... 240 VAC	12 VDC	2.5 A	88 % (typ.)	54 x 55 x 90	787-1201	4055143863308
	100 ... 240 VAC	12 VDC	5 A	89.0 (typ.)	72 x 55 x 90	787-1211	4055143804226
	100 ... 240 VAC	12 VDC	8 A	91.6% (typ.)	108 x 55 x 90	787-1221	4055143863360

*Height (H) from upper edge of the DIN-35 rail



Clear Indication

- Status indication via green LED
- Fast detection of current operating status

Supply Tolerance



- Single-phase, wide input voltage range
- High tolerance to voltage fluctuations within a power grid ensures a high level of operational reliability

Overhead Mounting

- Any type of mounting position is possible at reduced output power
- Units can even be mounted overhead, e.g., in ceiling-mounted distribution boxes

Safety Transformers

787 Series

Image	Input Voltage Range	Nominal Output Voltage	Output	Dimensions (W x H x D in mm)*	Item No.	EAN No.
	110/230 VAC	12/24 VAC	40 VA	126 x 54 x 90	787-974	4055143487382
	110/230 VAC	12/24 VAC	63 VA	144 x 54 x 90	787-976	4050821771678

*Height (H) from upper edge of the DIN-35 rail

DC/DC Converters

CAGE CLAMP®

787 Series

Image	Nominal Input Voltage	Nominal Output Voltage	Output Current	Efficiency	Dimensions (W x H x D in mm)*	Item No.	EAN No.
	24 VDC	5 VDC	0.5 A	82.5 %	6 x 97.8 x 94	787-2801	4055143407052
	24 VDC	10 VDC	0.5 A	85 %	6 x 97.8 x 94	787-2802	4055143407069
	48 VDC	24 VDC	0.5 A	91 %	6 x 97.8 x 94	787-2803	4055143454308
	24 VDC	12 VDC	0.5 A	90 %	6 x 97.8 x 94	787-2805	4055143407045
	24 VDC	5/10/12 VDC, adjustable	0.5 A	82.5 %	6 x 97.8 x 94	787-2810	4055143440745
	24 VDC	12 VDC	4 A	84%	45 x 90 x 107.5	787-1650	4055143737593
	110 VDC	24 VDC	2 A	85 %	72 x 55 x 89	787-1014	4050821819714
	72 VDC	24 VDC	2 A	86 %	72 x 55 x 89	787-1014/ 0072-0000	4055143256544
	72 VDC	12 VDC	4 A	85 %	72 x 55 x 89	787-1015/ 0072-0000	4055143621502

*Height (H) from upper edge of the DIN-35 rail



Commoning with 857/2857 Series

- A shared profile between the 787-28xx DC/DC Converters and the 857/2857 Series Relays and Signal Conditioners enables full commoning of the supply voltage.

Suitable for Railway Applications per EN 50155**

- Wide DC input voltage range
- Wide temperature range
- Protective coating

Communicative

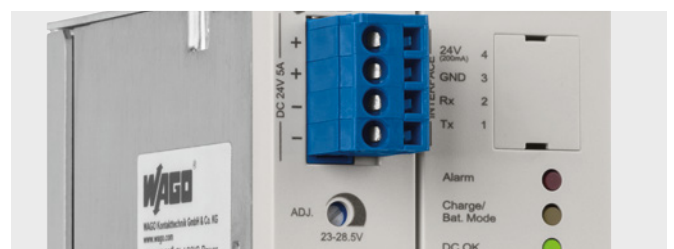
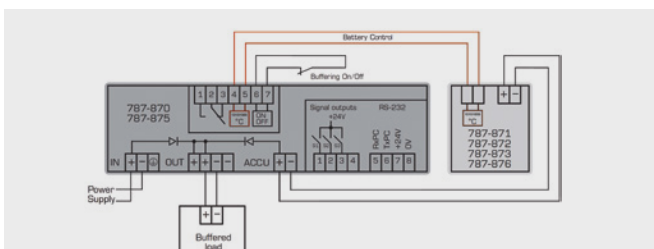
- Green LED indicates output voltage availability
- Remote monitoring via DC OK
- Easy commissioning and maintenance

**The DC/DC Converters are suitable for railway applications (787-1014/xxxx-xxxx).

UPS

787 Series

Image	Description	Nominal Input Voltage	Output Current	Buffer Time	Dimensions (W x H x D in mm)*	Item No.	EAN No.
	Power Supply; 1-phase; with integrated UPS charger and controller	100 ... 240 VAC	5 A	0.5 s ... 20 min, IPC mode or constant (adjustable)	60 x 135.5 x 127	787-1675	4050821502616
	UPS Charger and Controller	24 VDC	10 A	10 s ... 10 min, IPC mode or constant (adjustable)	40 x 163 x 163	787-870	4045454909857
			20 A	10 s ... 10 min, IPC mode or constant (adjustable)	57 x 163 x 171	787-875	4045454993917
	Lead-Acid (AGM) Battery Module	24 VDC	5 A	0.8 Ah	60 x 127 x 135.5	787-1671	4055143535724
			7.5 A (max.)	1.2 Ah	55 x 136.5 x 153	787-876	4050821298243
			20 A (max.)	3.2 Ah	76.2 x 175.5 x 168	787-871	4045454916626
			40 A (max.)	7 Ah	86 x 217.5 x 236	787-872	4045454909840
			40 A (max.)	12 Ah	120.5 x 217.5 x 236	787-873	4045454993900
	Pure Lead Battery Module	24 VDC	20 A	2.5 Ah	86 x 168 x 181	787-878 /000-2500	4055143738101
			40 A	13 Ah	22.5 x 199 x 187	787-878 /001-3000	4055143739177



Battery Control Technology

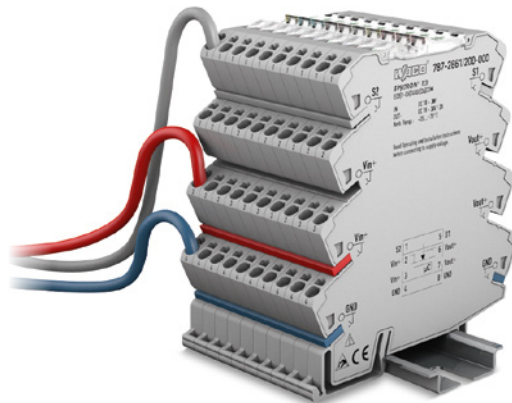
- Continuous data exchange between intelligent battery modules (787-87x) and UPS charger/controller prevents gas generation in the battery
- Automatic detection of 787-87x Battery Modules
- Maximized battery life via temperature-controlled battery management
- Reliable early warning of decreasing battery life
- Displays current charging status on site (787-870 and 787-875)

Diagnostics, Monitoring, Configuration

- LEDs display operating status, including warnings and errors
- Signal outputs can be processed as a digital signal in a PLC
- Potential-free signal contacts
- Parameter setting via on-unit buttons or rotary switch
- Visualization or configuration via RS-232 serial interface

Electronic Circuit Breakers

Compact and Precise ECBs for DC Circuits

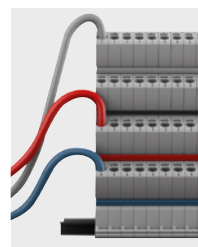


24 VDC				
1 Channel				
Electronic Circuit Breaker	Nominal Current	Color Coding	Item No.	EAN No.
	1 ... 8 A (adjustable)		787-2861/0108-0020	4055143693172
	1 A		787-2861/0100-0000	4055143533249
	2 A		787-2861/0200-0000	4055143533584
	4 A		787-2861/0400-0000	4055143533591
	6 A		787-2861/0600-0000	4055143533607
	8 A		787-2861/0800-0000	4055143533171



Push-In CAGE CLAMP® Connection

- Terminate solid and ferruled conductors via Push-in CAGE CLAMP® connections – no operating tool needed



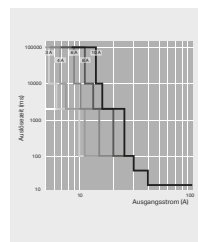
Easy Wiring

- Input potential up to 40 A via double connection
- Signal output can be commoned for up to 30 devices
- Total reset by commoning the signal inputs



Intuitive Status Indication

- Integrated multi-color LEDs indicate the operating status of each channel
- Push/slide switch for switching on/off and acknowledgment



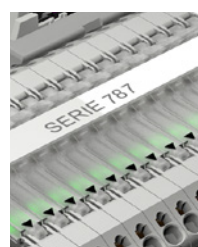
Trip Characteristics

- Reliable, rapid and precise disconnection in case of overcurrent or short circuit
- High switch-on capacities > 50,000 µF



Industry's Most Compact

- "True" 6.0 mm width maximizes panel space

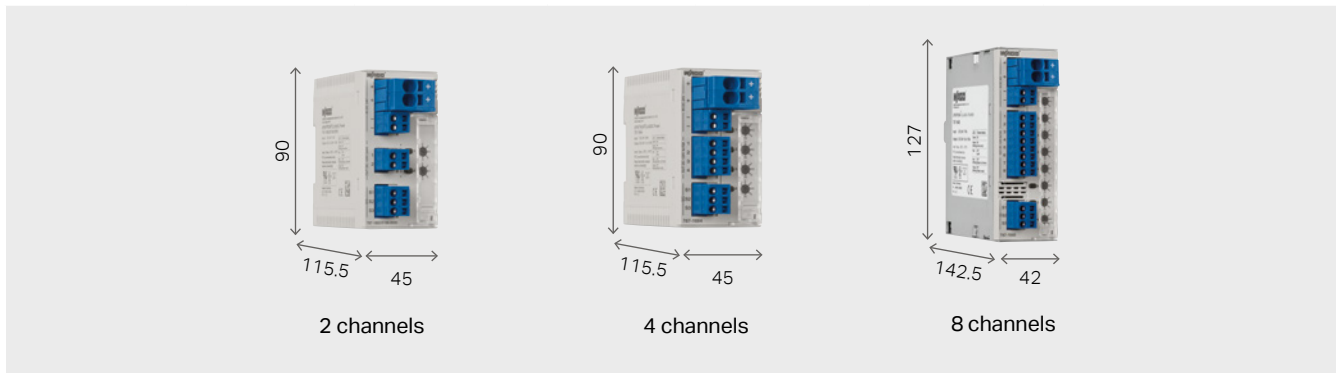


Marking

- Device identification via WMB Markers or TOPJOB® S Marking Strips
- With devices color coded according to nominal current

Electronic Circuit Breakers

Compact and Precise ECBs for DC Circuits



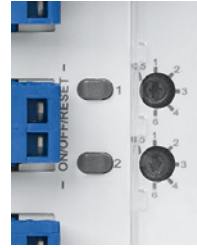
Nominal Voltage [V] DC	Number of Channels	Adjustable Nominal Current	Communication	Active Current Limitation	Special Configuration	Item No.
24	2	2 ... 10	M			787-1662
		2 ... 10	P		■	787-1662/0000-0054
		3.8 LPS	M	■		787-1662/0004-1000
		0.5 ... 6	P	■		787-1662/0006-1000
		1 ... 6	M			787-1662/0106-0000
24	4	2 ... 10	M			787-1664
		2 ... 10	M		■	787-1664/0000-0011
		2 ... 10	M		■	787-1664/0000-0004
		2 ... 10	P		■	787-1664/0000-0054
		1 ... 10	I			787-1664/0000-0080
		3.8 LPS	M	■		787-1664/0004-1000
		0.5 ... 6	M	■		787-1664/0006-1000
		1 ... 6	M			787-1664/0106-0000
		1 ... 6	M		■	787-1664/0106-0011
		2 ... 12	M	■		787-1664/0212-1000
0.5 ... 6	P	■		■	787-1664/0006-1054	
24	8	2 ... 10	M			787-1668
		2 ... 10	M		■	787-1668/0000-0004
		2 ... 10	P		■	787-1668/0000-0054
		1 ... 10	I			787-1668/0000-0080
		0.5 ... 6	M	■		787-1668/0006-1000
		1 ... 6	M			787-1668/0106-0000
		0.5 ... 6	P	■		■
12	4	2 ... 10	M			787-1664/0000-0100
48	4	2 ... 10	P			787-1662/0000-0250
		2 ... 10	M			787-1664/0000-0200
		2 ... 10	P			787-1664/0000-0250
	8	2 ... 10	M			787-1668/0000-0200
		2 ... 10	P			787-1668/0000-0250

S = Signal
P = Potential-free signal
I = IO-Link protocol
M = Manchester protocol



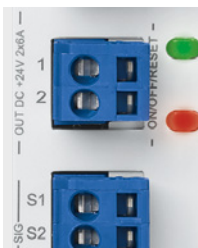
Pluggable CAGE CLAMP® Connection Technology

- Fast, vibration-proof, maintenance-free
- For solid, fine-stranded and ferruled conductors
- 100% protected against mismatching
- With marking



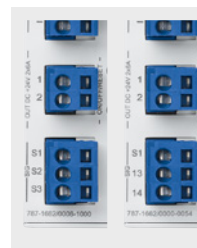
Rotary Switch

- Nominal current can be individually adjusted for each channel
- The setting is visible – even when no voltage is applied
- Transparent cover can be sealed and marked



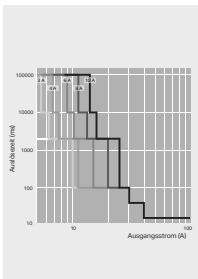
Intuitive Status Indication

- Each output channel has backlit buttons for switching on/off, as well as status acknowledgement
- Integrated, multi-color LEDs indicate the operating status of each channel



Communication 1.0

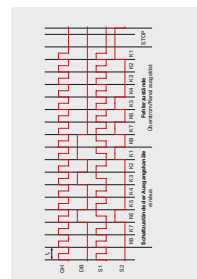
- Remote digital input S1 resets all tripped channels
- Digital output S3 transmits a simple group message indicating whether one of the channels was triggered by an overcurrent.
- Optional isolated signal contact 13/14 as group signal



Trip Characteristics

- Reliable and precise disconnection in case of overcurrent or short circuit
- Nominal currents can be set separately for each channel in 1 A increments
- Tripping time can be configured in defined increments
- Optional, active short circuit current limitation to 1.7 times the nominal current prevents a voltage drop in other current paths

*only for 787-166x/xxxx-1xxx



Communication 2.0

- Remote digital input (S1) switches certain channels on and off via pulse sequence
- Digital output S2 transmits the current status (on/off/tripped/overcurrent) of each individual channel
- Optional transmission of input voltage and output/nominal current value for each channel



Marking

- Device identification via WMB Markers or TOPJOB® S Marking Strips
- Label individual channels via marking strips that can be inserted into the rotary switch cover from the outside





Communication 3.0

- IO-Link interface
- Read both the status and nominal current setting, as well as actual voltage/current values per channel
- Set the nominal current, switch on/off and reset individual channels


Capacitive Buffer Modules

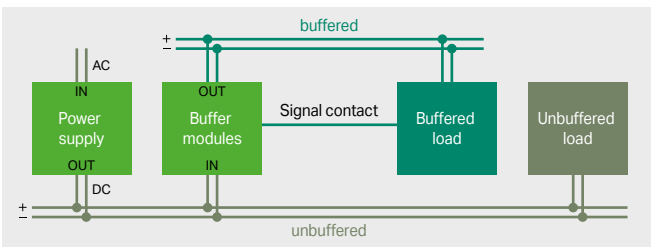
787 Series

Image	Description	Nominal Input Voltage	Output Current	Buffer Time	Efficiency	Dimensions (W x H x D in mm)*	Item No.	EAN No.
	Capacitive Buffer Module	24 VDC	10 A	0.06 ... 7.2 s (depends on load current and switch-on threshold)	–	57 x 179 x 163	787-880	4045454909833
			20 A	0.17 ... 16.5 s (depends on load current and switch-on threshold)	–	57 x 179 x 181	787-881	4045454909826

*Height (H) from upper edge of the DIN-35 rail

IP67 Power Supply

Image	Description	Nominal Input Voltage	Output Voltage	Output Current	Efficiency	Dimensions (W x H x D in mm)*	Item No.	EAN No.
	IP67 Power Supply	100 ... 240 VAC	24 VDC	4 A	92.3 %	111 x 141 x 54	787-6716	4055143644877



Decoupled Output


- Integrated diode
- Buffered and unbuffered loads can be decoupled
- Multiple buffer modules can be parallel-connected to increase buffer time or load current

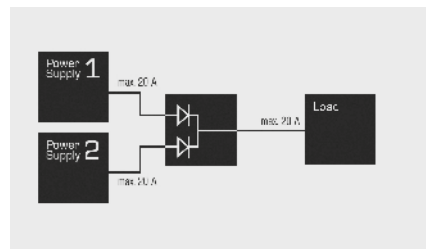
Signaling

- Three LEDs (green/yellow/red) indicate the current operating status
- A potential-free signal contact indicates the charge level

Redundancy Modules

787 Series

Image	Description	Nominal Input Voltage	Nominal Output Voltage	Output Current	Efficiency	Dimensions (W x H x D in mm)*	Item No.	EAN No.
	Redundancy Module	2 x 24 VDC	24 VDC	20 A, 40 A (max.)	97 % (typ.)	40 x 163 x 181	787-885	4045454909802
	Redundancy Module	2 x 48 VDC	48 VDC	20 A, 40 A (max.)	96 % (typ.)	40 x 163 x 181	787-886	4050821262725
	Redundancy Module	2 x 24 VDC	24 VDC	20 A, 40 A (max.)	99.5 % (typ.)	42 x 139.5 x 127	787-1685	4055143534529
	Diode Redundancy Module	2 x 24 VDC (9 ... 54 VDC)	1 x 9 ... 54 VDC	12.5 A (max.) as redundancy module, 25 A (max.) in parallel operation	96 % (typ.)	50 x 92 x 130	787-783	4055143036290
	Diode Redundancy Module	2 x 24 VDC (9 ... 54 VDC)	1 x 9 ... 54 VDC	40 A (max.) as redundancy module, 76 A (max.) in parallel operation	97 % (typ.)	83 x 153 x 130	787-785	4055143036306



Signaling

- Three LEDs indicate the presence of an input or output voltage
- Optionally, an isolated signal contact** indicates a power outage at the input

High Overload Capability

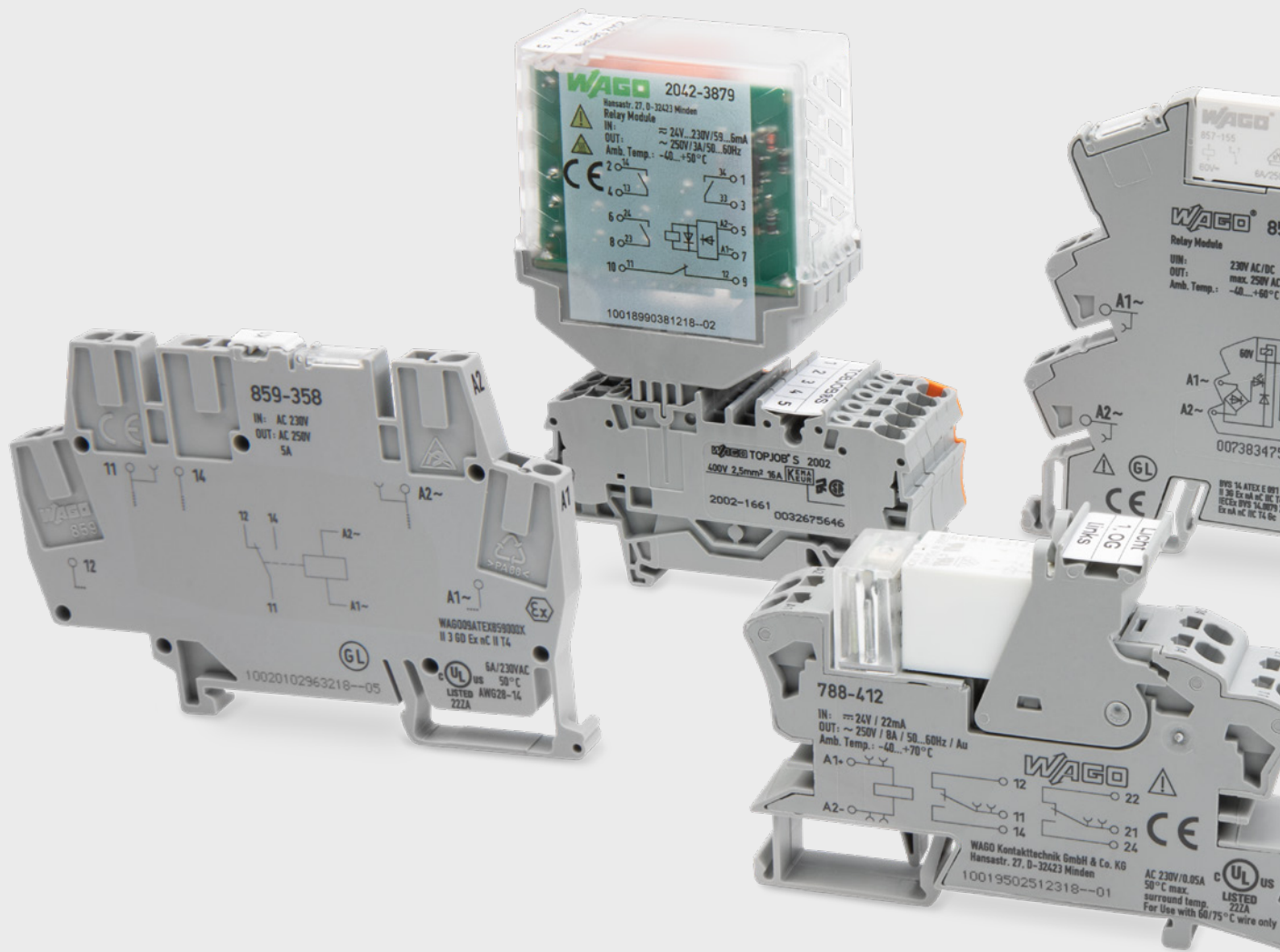
- Power diodes in each input path

**only for 787-885 and -886

feature a high overload capacity and are also suitable for power supplies with TopBoost or PowerBoost

- Commoning the input paths permits output currents up to 76 A





Relay and Optocoupler Modules

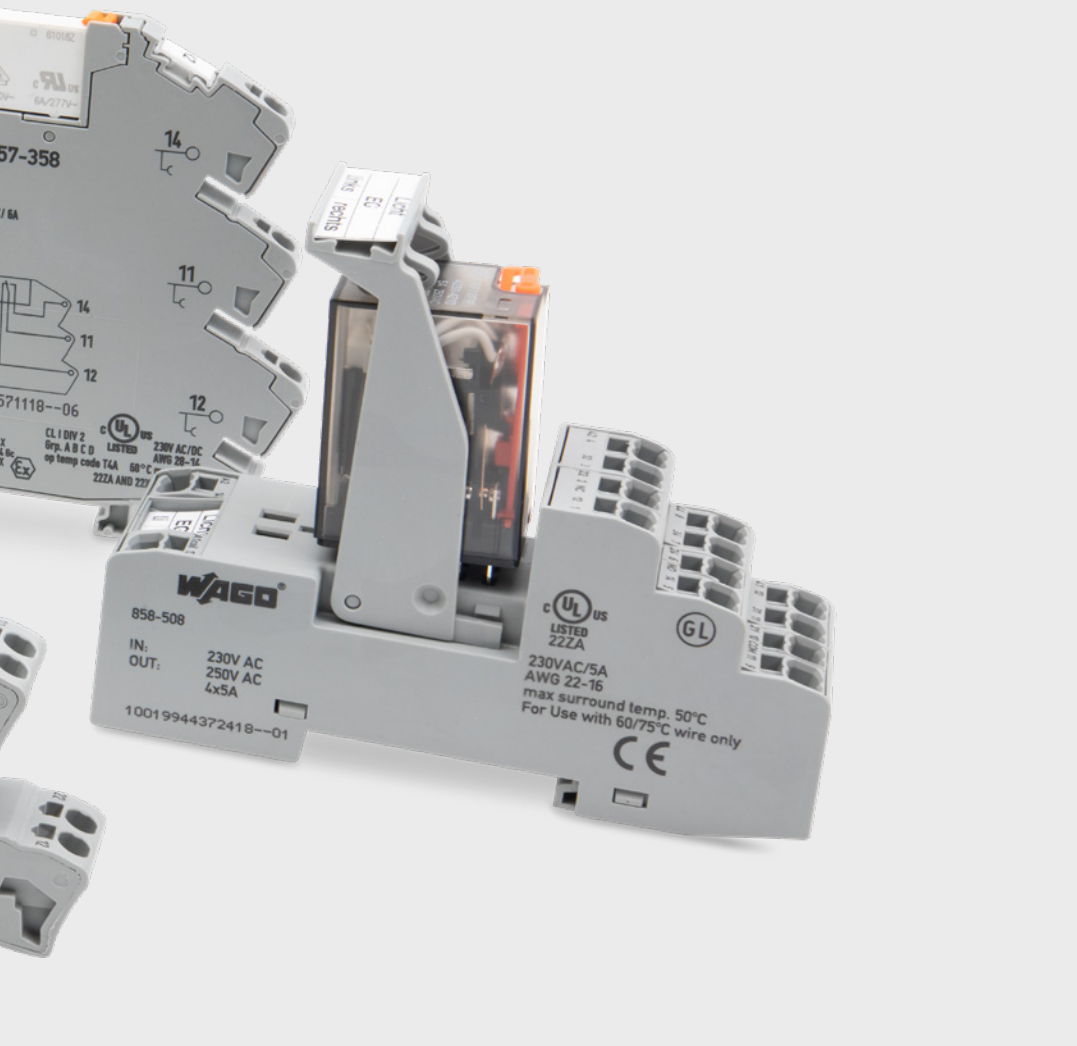
Product Overview

Relay Modules

In modern automation systems, electromechanical relays safely connect process peripherals with electronic control, alarm and monitoring systems. Depending on the application and its requirements, there is a choice of relay modules with different rated voltages, contacts, contact materials, housings and designs. In addition to standard switching relays, other relay models are available including bistable, timer, latching and safety relays with force-guided contacts.

Optocouplers

Optocouplers connect process peripherals with electronic control, alarm and monitoring systems. WAGO offers a full range of optocouplers for all interfaces between control and load circuits. Optocouplers are available with different nominal voltages, switching capacities and housing options to suit any application.



788 Series

Sockets with Miniature Switching Relay or Solid-State Relay

858 Series

Sockets with Miniature Switching Relay

789 Series

Relay Modules in a DIN-Rail-Mount Enclosure

859 Series

Rail-Mount Terminal Blocks with a Miniature Switching Relay or an Optocoupler

857 Series

- Sockets with Miniature Switching Relay or Solid-State Relay
- Timer Relays
- Relays with Wide Input Voltage Range
- Relays for Long Cable Lengths

2042 Series

Pluggable Relay Modules or Solid-State Relay Modules for WAGO Rail-Mount Terminal Blocks TOPJOB® S

Relay Modules


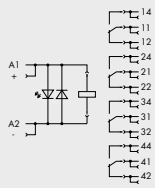

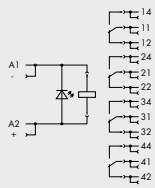
788 Series

Sockets with a Miniature Switching Relay

Image	Description	Nominal Input Voltage U_N	Max. Switching Voltage	Limiting Continuous Current	Item No.	EAN No.
	Relay Module with 1 Changeover Contact and Status Indication		24 VDC	250 VAC	16 A	788-304 4055143184113
	Relay Module with 2 Changeover Contacts and Status Indication		24 VDC	250 VAC	2 x 8 A	788-312 4055143184137
	Relay Module with 1 Changeover Contact and Status Indication		230 VAC	250 VAC	16 A	788-508 4055143192347
	Relay Module with 2 Changeover Contacts and Status Indication		230 VAC	250 VAC	2 x 8 A	788-516 4055143192378
	Relay Module with 1 Changeover Contact and Status Indication		24 VDC	250 VAC	16 A	788-354 4055143184168
	Relay Module with 1 Changeover Contact; with Gold Contacts and Status Indication		24 VDC	250 VAC*	16 A*	788-404 4045454352158
	Relay Module with 2 Changeover Contacts; with Gold Contacts and Status Indication (15 mm high relay)		24 VDC	250 VAC*	2 x 8 A*	788-412 4045454352165
	Relay Module with 1 Changeover Contact; with Gold Contacts and Status Indication		230 VAC	250 VAC*	16 A*	788-608 4045454484798
	Relay Module with 2 Changeover Contacts; with Gold Contacts and Status Indication		230 VAC	250 VAC*	2 x 8 A*	788-616 4045454484804
	Relay Module with 1 Changeover Contact; Manual Operation and Status Indication		24 VDC	250 VAC	16 A	788-341 4050821226758
	Relay Module with 2 Changeover Contacts; Manual Operation and Status Indication		24 VDC	250 VAC	2 x 8 A	788-346 4050821226864
	Relay Module with 1 Changeover Contact; Manual Operation and Status Indication		230 VAC	230 VAC	2 x 8 A	788-544 4050821226871
	Relay Module with 2 Changeover Contacts; Manual Operation and Status Indication		230 VAC	250 VAC	2 x 8 A	788-549 4050821226802

858 Series

Sockets with an Industrial Relay

Image	Description		Nominal Input Voltage U_N	Max. Switching Voltage	Limiting Continuous Current	Item No.	EAN No.
	Industrial Relay Module with 4 Changeover Contacts		24 VDC	250 VAC	4 x 5 A	858-304	4045454902902
	Industrial Relay Module with 4 Changeover Contacts; with Gold Contacts		24 VDC	250 VAC*	4 x 5 A*	858-314	4045454902926
	Industrial Relay Module with 4 Changeover Contacts		230 VAC	250 VAC	4 x 5 A	858-508	4045454902933
	Industrial Relay Module with 4 Changeover Contacts; with Gold Contacts		230 VAC	250 VAC*	4 x 5 A*	858-518	4045454902940

*To avoid damaging the gold layer, 30 VDC switching voltages and 50 mA currents must not be exceeded. Higher switching power eventually evaporates the gold layer. The resulting deposits in the housing may reduce service life.


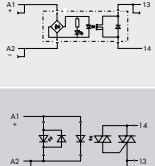

Accessories

Image	Description	Max. Continuous Current	Item No.	EAN No.
	Push-In Type Jumper Bar, 2-way, for power distribution between relays	12 A	858-402	4045454868109



Solid-State Relay Modules

788 Series

Sockets with a Solid-State Relay

Image	Description		Nominal Input Voltage U_N	Nominal Output Voltage	Limiting Continuous Current	Item No.	EAN No.
	Socket with a Solid-State Relay Module		24 VDC	0 ... 35 VDC	5 A	788-710	–
	Solid-State Relay Module		24 VDC	24 ... 240 VAC	3.5 AAC	788-730	–

Accessories

Image	Description	Max. Continuous Current	Item No.	EAN No.
	Push-In Type Jumper Bar, 2-way, for power distribution between relays	17 A	788-113	4044918508605
	Push-In Type Jumper Bar, 2-way, for connecting contact sets within a module	17 A	859-402	4044918506434

Pluggable Modules for WAGO Rail-Mount Terminal Blocks TOPJOB® S

PUSH-IN CAGE CLAMP®

2042 Series

Relay Modules											
	Image	Nominal Input Voltage	Input Voltage Range	Switching Voltage	Limiting Continuous Current				Item No.	EAN No.	
		24 VDC	-30 ... +25 %	250 VAC	6 A		1		2042-3004	4055143709477	
					8 A		2		2042-3014	4055143651677	
					5 A		4		2042-3024	4055143651691	
					10 A		1		2042-3034	4055143651912	
					8 A		2		2042-3044	4055143651707	
					6 A		1		2042-3054	4055143709507	
					8 A		1	1	2042-3064	4055143651714	
					5 A		1	3	2042-3074	4055143606820	
		5 A			2	2	2042-3084	4055143651745			
		3 A	24 ... 230 V AC/DC		+/- 10 %	3 A		1		2042-3809	4055143709538
		5 A					2		2042-3819	4055143651752	
		3 A					4		2042-3829	4055143651936	
		4 A					1		2042-3839	4055143651943	
		5 A					2		2042-3849	4055143651929	
		6 A					1		2042-3859	4055143709569	
		5 A					1	1	2042-3869	4055143651950	
		3 A					1	3	2042-3879	4055143652001	
		3 A					2	2	2042-3889	4055143652025	
	Solid-State Relay Modules										
		Image	Nominal Input Voltage		Input Voltage Range	Switching Voltage Range	Limiting Continuous Current	Contact		Item No.	EAN No.
		24 VDC (10 kHz)	16.8 ... 30 VDC	0 ... 60 VDC	0.1 A	2-wire		2042-7204	4055143751353		
		24 VDC (100 kHz)	16.8 ... 30 VDC	2 ... 32 VDC	0.5 A	3-wire		2042-7304	4055143748728		
		24 VDC (1 kHz)	10 ... 53 VDC	3 ... 53 VDC	4 A	2-wire		2042-7504	4055143751292		
		24 VDC (5 kHz)	16.8 ... 30 VDC	20 ... 30 VDC	5 A	3-wire		2042-7604	4055143748759		
Switching Modules											
	Image	Function	Switching Voltage	Switching Current	Item No.	EAN No.					
		Switch	250 VAC	10 A	2042-1008	-					
		Button	250 VAC	10 A	2042-1108	-					

WAGO Relay Modules

789 Series


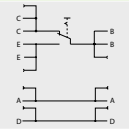

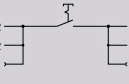
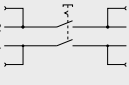

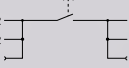

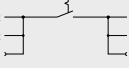
Relay Modules in a DIN-Rail-Mount Enclosure

Image	Description		Nominal Input Voltage U_N	Max. Switching Voltage	Limiting Continuous Current	Item No.	EAN No.
	Relay Module with 1 Changeover Contact		24 VDC	250 VAC	12 A	789-304	4045454313005
	Relay Module with 1 Changeover Contact		230 VAC	250 VAC	12 A	789-508	4017332819398
	Relay Module with 2 Changeover Contacts		24 VDC	250 VAC	8 A	789-312	4045454313043
	Relay Module with 2 Changeover Contacts		230 VAC	250 VAC	8 A	789-516	4045454388218
	Relay Module with 4 Make Contacts		24 VDC	250 VAC	4 AAC	789-352	4045454762957
	Relay Module with 1 Make Contact; Manual/OFF/Auto switch		24 VDC	250 VAC	16 A	789-323	4045454550608
						789-325	4050821110132
	Relay Module with 1 Changeover Contact; Manual/OFF/Auto switch with feedback contact		24 VDC	250 VAC	12 A	789-329	4050821110149
	Relay Module with 1 Changeover Contact and Manual Operation		24 VDC	250 VAC	12 A	789-1341	4050821386728
	Relay Module with 2 Changeover Contacts; Manual Operation		24 VDC	250 VAC	8 A	789-1346	4050821386773
	Relay Module with 1 Changeover Contact and Manual Operation		230 VAC	250 VAC	12 A	789-1544	4050821386780
	Relay Module with 2 Changeover Contacts; Manual Operation		230 VAC	250 VAC	8 A	789-1549	4050821386797


Relay Modules

789 Series

Switching Modules

Image	Description		Max. Switching Voltage	Max. Continuous Current	Item No.	EAN No.
	Switching Module; Changeover, 1-pole		250 VAC	10 A	789-800	4017332792554
	Switching Module; Breaker, 1-pole		250 VAC	16 A	789-801	4050821274742
	Switching Module; Breaker, 2-pole		250 VAC	16 A	789-802	4050821274810
	Switching Module; Switch, 1-pole		250 VAC	16 A	789-803	4050821274827
	Switching Module; Push-Button Switch, 1-pole		250 VAC	16A	789-804	4050821274834

Accessories

Image	Description	Max. Continuous Current	Item No.	EAN No.
	Push-In Type Jumper Bar; 12-way; for power distribution between relays	16 A	789-112	4044918861236

859 Series

Rail-Mount Terminal Blocks with a Miniature Switching Relay


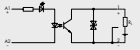

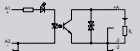
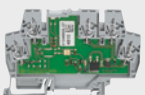
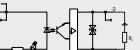
Image	Description	Nominal Input Voltage U_N	Max. Switching Voltage	Limiting Continuous Current	Item No.	EAN No.
	Relay Module with 1 Changeover Contact	 24 VDC	250 VAC	5 A	859-304	4050821809661
	Relay Module with 1 Changeover Contact	 230 VAC/DC	250 VAC	5 A	859-358	4045454304959
	Relay Module with 1 Changeover Contact; with Gold Contacts	 24 VDC	250 VAC*	5 A*	859-314	4045454293741
	Relay Module with 1 Changeover Contact; with Gold Contacts	 230 VAC	250 VAC*	5 A*	859-359	4045454503789
	Relay Module with 1 Changeover Contact; with Gold Contacts	 115 VAC	250 VAC*	5 A*	859-360	4045454317546
	Relay Module with 1 Changeover Contact; with defined switch-on/off threshold	 230 VAC	250 VAC	5 A	859-368	4045454565831

*To avoid damaging the gold layer, 30 VDC switching voltages and 50 mA currents must not be exceeded. Higher switching power eventually evaporates the gold layer. The resulting deposits in the housing may reduce service life.

Optocoupler Modules

859 Series

Rail-Mount Terminal Blocks with an Optocoupler


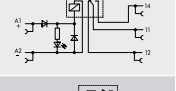
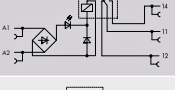


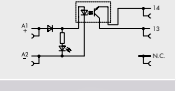
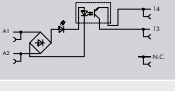

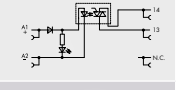
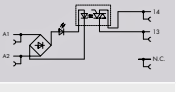

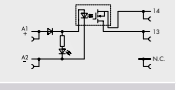
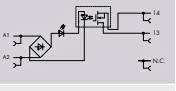

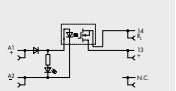
Image	Description	Nominal Input Voltage U_N	Nominal Output Voltage	Limiting Continuous Current	Item No.	EAN No.
	Optocoupler Module	 24 VDC	3 ... 30 VDC	100 mA	859-796	4045454198473
	Power Optocoupler	 24 VDC	3 ... 30 VDC	3 A	859-730	4050821351597
	Optocoupler Module	 DC 48 V	DC 3 ... 53 V	4 A	859-744	—

Note: For rail-mount terminal blocks with overvoltage protection (792 Series), see Full Line Catalog.

WAGO Relay Modules


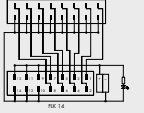

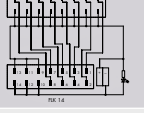


857 Series

Sockets with a Miniature Switching Relay or a Solid-State Relay

Image	Description		Nominal Input Voltage U_N	Max. Switching Voltage	Limiting Continuous Current	Item No.	EAN No.
	Relay Module with 1 Changeover Contact		24 VDC	250 VAC	6 A	857-304	4050821797807
			230 VAC/DC	250 VAC	6 A	857-358	4045454471576
	Relay Module with 1 Changeover Contact; with gold contacts		24 VDC	250 VAC*	6 A*	857-314	4050821809258
			230 VAC/DC	250 VAC*	6 A*	857-368	4045454673482
	Solid-State Relay Module		24 VDC	0 ... 48 VDC	100 mA	857-704	4045454835491
			230 VAC/DC	0 ... 48 VDC	100 mA	857-708	4045454835514
	Solid-State Relay Module		24 VDC	24 ... 240 VAC	1 A	857-714	4045454835545
			230 VAC/DC	24 ... 240 VAC	1 A	857-718	4045454835521
	Solid-State Relay Module		24 VDC	0 ... 24 VDC	2 A	857-724	4045454835552
			230 VAC/DC	0 ... 24 VDC	2 A	857-728	4045454835484
	Solid-State Relay Module		DC 24 V	DC 30V	8 A	857-734	—

*To avoid damaging the gold layer, 30 VDC switching voltages and 50 mA currents must not be exceeded. Higher switching power eventually evaporates the gold layer. The resulting deposits in the housing may reduce service life.


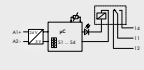



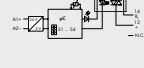

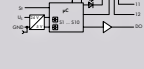

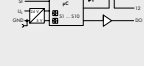
8-Channel Interface Adapters for System Wiring

Image	Description		Nominal Voltage	Current Carrying Capacity per Channel	Limiting Continuous Current	Item No.	EAN No.
	8-Channel Adapter; with 14-pole interface cable connector; high-side switching input		24 VDC	1 A	2.5 A	857-981	4045454995171
	8-Channel Adapter; with 14-pole interface cable connector; high-side switching output		24 VDC	1 A	2.5 A	857-982	4045454995188
	WAGO Ribbon Cable; 14-pole/free end; 2 m long					0706-0100/1303-0200	4050821452423


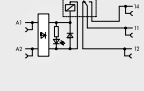

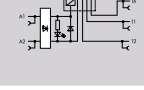
Additional cable types and lengths are available upon request.

857 Series

Timer Relay Modules


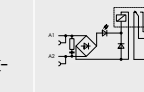

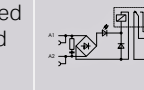
Image	Description	Input Voltage Range	Output Voltage Range	Max. Continuous Current	Item No.	EAN No.
	Multifunction Timer Relay with 1 Changeover Contact; 4 functions; 4 time ranges: 0.1 s ... 300 min	 16.8 ... 31.2 VDC	250 VAC	6 A	857-604	4050821565673
	Solid-State Relay Module with 1 Make Contact; 4 functions; 4 time ranges: 0.1 s ... 300 min	 20.4 ... 31.2 VDC	0 ... 24 VDC	2 A	857-624	4050821565680
	Solid-State Relay Module with 1 Make Contact; 4 functions; 4 time ranges: 0.1 s ... 300 min	 20.4 ... 31.2 VDC	24 ... 230 VAC	1 A	857-634	4050821565697
	Multifunction Timer Relay with 1 Changeover Contact; 14 functions; 8 time ranges	 16.8 ... 31.2 VDC	250 VAC	6 A	857-640	4050821565703
	Multifunction Timer Relay with 1 Changeover Contact; 7 functions; 2 x 8 time ranges	 16.8 ... 31.2 VDC	250 VAC	6 A	857-642	4050821565710

Relay Modules with a Wide Input Voltage Range

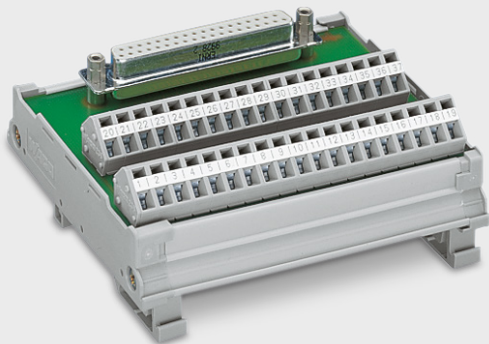
Image	Description	Input Voltage Range	Output Voltage Range	Max. Continuous Current	Item No.	EAN No.
	Relay with 1 Changeover Contact (1 u); for normal switching power; with a wide input voltage range	 24 ... 230 V AC/DC -30 ... +10 %	250 VAC	6 A	857-359	4050821856689
	Relay with 1 Changeover Contact (1 u); for normal switching power; with a wide input range and gold contact	 24 ... 230 V AC/DC -30 ... +10 %	250 VAC*	6 A*	857-369	4050821854241

*To avoid damaging the gold layer, 30 VDC switching voltages and 50 mA currents must not be exceeded. Higher switching power eventually evaporates the gold layer. The resulting deposits in the housing may reduce service life.

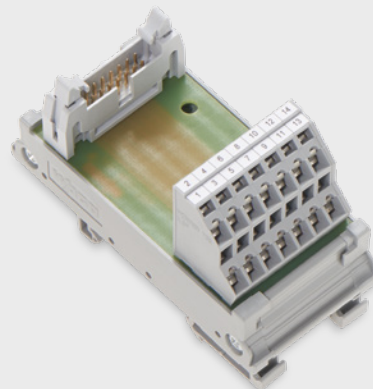
Relay Modules for Long Cable Lengths

Image	Description	Input Voltage Range	Output Voltage Range	Max. Continuous Current	Item No.	EAN No.
	Relay with 1 Changeover Contact (1 u); with integrated base load module; Nominal input voltage U_N ; 230 VAC	 UN -15 ... +10 %	250 VAC	6 A	857-358/ 006-000	4050821873396
	Relay with 1 Changeover Contact (1 u); with integrated base load module and gold contacts; Nominal input voltage U_N ; 230 VAC	 UN -15 ... +10 %	250 VAC*	6 A*	857-368/ 006-000	4050821873402

*To avoid damaging the gold layer, 30 VDC switching voltages and 50 mA currents must not be exceeded. Higher switching power eventually evaporates the gold layer. The resulting deposits in the housing may reduce service life.



**Interface Modules with
D-Sub Male Headers or Sockets**



**Interface Modules with a
Pluggable Connector per DIN
41 651**

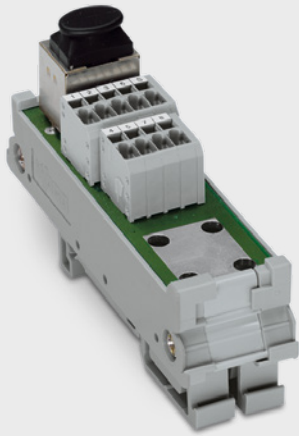
Interface Modules

Product Overview

Interface modules connect electronics to electrical systems at the control level and perform signal transmission and distribution in the control and field levels (system, machine) and vice versa.

Here, the control signals from pre-assembled, plug-in connections are applied to terminal block connections. Use of these interface modules provides the following benefits for system wiring:

- Expedited wiring, commissioning and troubleshooting thanks to inherently clear wiring and pole marking
- Reduction of wiring errors
- Secure and maintenance-free connections for signal lines using CAGE CLAMP® connection technology
- The interface modules can be delivered as standard, in a universal DIN-35 rail mounting carrier for pluggable connectors



RJ-45 Interface Modules

**Interface Modules with
D-Sub Male Headers or Sockets**
with 9, 15, 25, 37 or 50 connectors


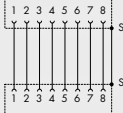

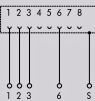
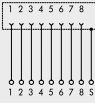


**Interface Modules
with a Pluggable Connector per DIN 41 651**
with 10-, 14-, 16-, 20-, 26-, 34-, 40-, 50- and 64-pole
male headers

RJ-45 Interface Modules
for PC, network and telephone service applications

Interface Modules


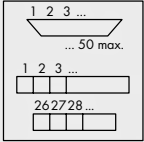

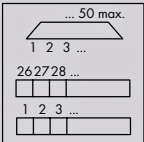

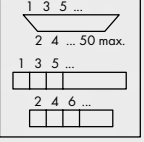

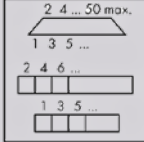
289 Series

RJ-45 Interface Modules




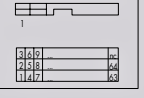
Image	Description		Item No.	EAN No.
	RJ-45 Interface Module; DIN-35 rail mounting carrier		289-172	4045454317478
	RJ-45 Interface Module; with shield carrier for WAGO Shield Clamping Saddle; DIN-35 rail mounting carrier		289-174	4045454317492
	RJ-45 Interface Module; with shield carrier for WAGO Shield Clamping Saddle; DIN-35 rail mounting carrier		289-175	4045454317522
	Shielded RJ-45 Cat. 6 Interface Module; mounting adapter for DIN-35 rail		289-195	4055143292986
	WAGO Shield Clamping Saddle (11 mm wide; cable diameter up to 8 mm)		790-108	4017332356954

289 Series

Interface Modules with D-Sub Connectors

Image	Description		Pole No.	Operating Voltage	Nominal Current	Item No.	EAN No.
	Interface Module; with D-subminiature male header; for mating connectors with solder connection; Vertical insertion; Mounting carrier for DIN-35 rail		9 15 25 37 50	100 VAC 125 VDC	2 A	289-545 289-546 289-547 289-548 289-549	4045454413804 4045454413583 4045454362171 4045454366971 4045454322779
	Interface Module; with D-subminiature socket; for mating connectors with solder connection; Vertical insertion; Mounting carrier for DIN-35 rail		9 15 25 37 50	100 VAC 125 VDC	2 A	289-555 289-556 289-557 289-558 289-559	4045454371180 4045454417857 4045454432683 4045454501303 4045454409746
	Interface Module; with subminiature D-male connector; for mating connectors with IDC; Vertical insertion; Mounting carrier for DIN-35 rail		9 15 25 37 50	100 VAC 125 VDC	2 A	289-540 289-541 289-542 289-543 289-544	4045454466121 4045454413569 4045454362096 4045454366964 4045454452216
	Interface Module; with D-subminiature socket; for mating connectors with IDC connection; Vertical insertion; Mounting carrier for DIN-35 rail		9 15 25 37 50	100 VAC 125 VDC	2 A	289-550 289-551 289-552 289-553 289-554	4045454371173 4045454417840 4045454460228 4045454498559 4045454409739

Interface Modules with a Ribbon Cable Connector per DIN 41651

Image	Description		Pole No.	Operating Voltage	Nominal Current	Item No.	EAN No.
	Interface Module for Ribbon Cable Connector per DIN 41651; Mounting carrier for DIN-35 rail		10-pole 14-pole 16-pole	100 VAC 125 VDC	1 A	289-611 289-612 289-613	4045454471200 4045454353575 4045454405465
	Interface Module for Ribbon Cable Connector per DIN 41651; Mounting carrier for DIN-35 rail		20-pole 26-pole 34-pole 40-pole 50-pole 64-pole	100 VAC 125 VDC	1 A	289-614 289-615 289-616 289-617 289-618 289-619	4045454011543 4045454353582 4045454353599 4045454353612 4045454353629 4045454329877

WAGO Kontakttechnik GmbH & Co. KG

Postfach 2880 · 32385 Minden
Hansastraße 27 · D-32423 Minden

info@wago.com
www.wago.com

Headquarters	+49 571/887 - 0
Sales	+49 571/887 - 44 222
Orders	+49 571/887 - 44 333
Fax	+49 571/887 - 844 169

WAGO is a registered trademark of WAGO Verwaltungsgesellschaft mbH.

“Copyright – WAGO Kontakttechnik GmbH & Co. KG – All rights reserved. The content and structure of the WAGO websites, catalogs, videos and other WAGO media are subject to copyright. Distribution or modification of the contents of these pages and videos is prohibited. Furthermore, the content may neither be copied nor made available to third parties for commercial purposes. Also subject to copyright are the images and videos that were made available to WAGO Kontakttechnik GmbH & Co. KG by third parties.”