

Our Power Team

High-Current, Rail-Mount Terminal Blocks
for Conductors up to 185 mm² (350 kcmil)

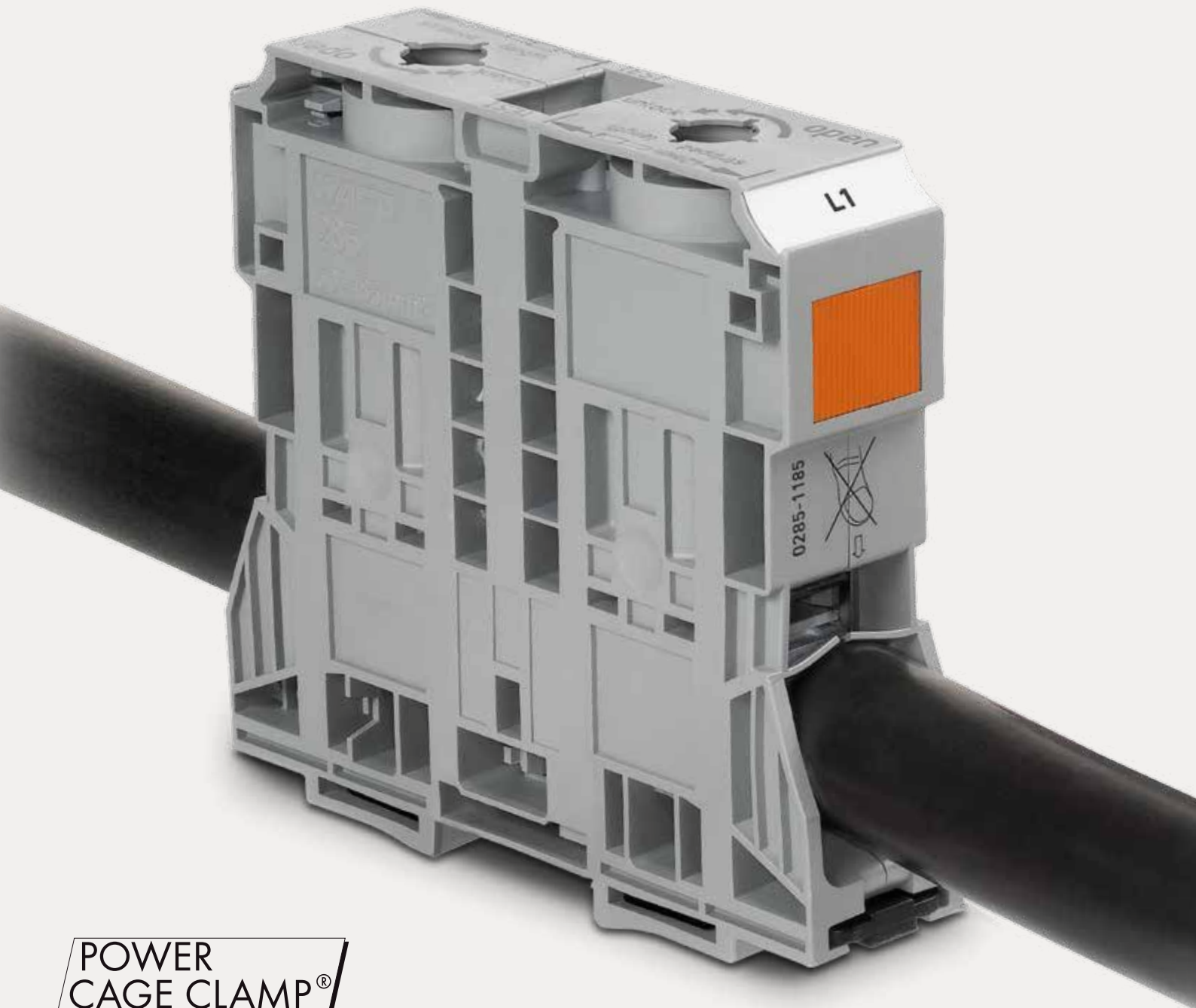

**POWER
CAGE CLAMP®**

Vibration-Proof – Fast – Maintenance-Free



© WAGO

BENEFITS

The key to WAGO's success: springs, not screws. This design gives POWER CAGE CLAMP the appropriate clamping force for conductors up to 35, 50, 95 and 185 mm² (2, 2/0, 4/0 AWG and 350 kcmil).

WAGO's high-current, rail-mount terminal blocks are mainly used in energy-intensive industries, including machinery and equipment manufacturing, as well as energy production.

WAGO also offers 35, 50, 95 and 185 mm² (2, 2/0, 4/0 AWG and 350 kcmil) Ex e rail-mount terminal blocks for use in hazardous areas.

The following models are approved per DIN EN 60079-0 and DIN EN 60079-7: 2-conductor through terminal blocks (light gray) and ground conductor terminal blocks (green-yellow) with ".../999-950" suffix number.

Select accessories (e.g., jumpers and power taps) are also certified to provide switchgear manufacturers with full flexibility when high-current, rail-mount terminal blocks are used in hazardous locations.

The Largest Member of Our High-Current Family:

Connect 185 mm² (350 kcmil) via spring pressure

Technical features:

- 353 A
- Up to 1000 VAC/DC
- Up to 1500 VDC

Perfect for Every Application

- The high-current terminal blocks meet the most stringent requirements, including those specified for railway and marine applications.
- They resist hot and cold – even under the heaviest of loads.

Optimum Clamping Force

- The contact quality is largely independent of operator skill.

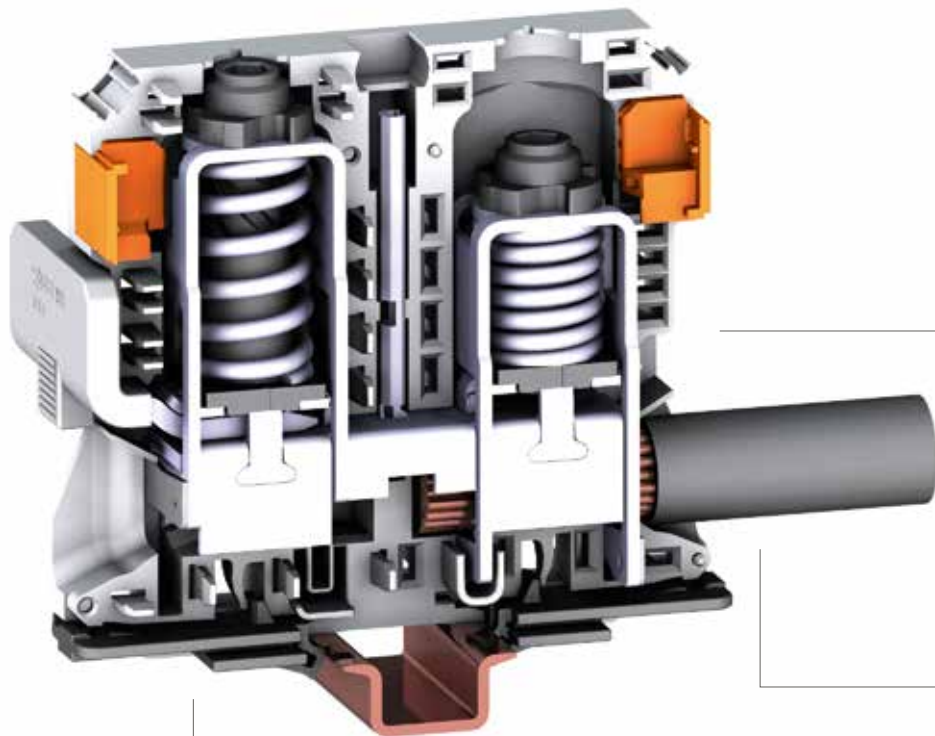

Easy to Use

- Side conductor entry
- Orange locking tab keeps the clamp open for hands-free wiring.

Connection

- Eliminate time-consuming preparation – no ring terminals or ferrules required.

Vibration-Proof – Fast – Maintenance-Free

OUR POWER TEAM

Terminate Conductors up to 185 mm² (350 kcmil) with Just One Turn

Mounting

- Firmly snap a ground conductor terminal block onto DIN-rail.
- The contact foot is secured, providing the appropriate power grounding connection. Use a 2.3 mm copper carrier rail.

Marking

- WMB markers are suitable for all high-current terminal blocks.
- Apply marking strips directly to both 35 mm² (2 AWG) and 185 mm² (350 kcmil) terminal blocks.
- Use marking strip carriers for 35 ... 95 mm² (2 ... 4/0 AWG) terminal blocks.



Conductor Termination



Rotate the T-wrench or screwdriver counter-clockwise to the stop ①. Next, push in the orange locking tab. The clamp is locked open for hands-free wiring.

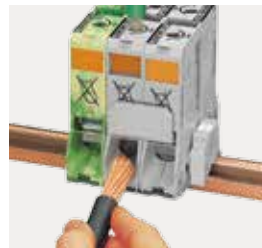

Insert a stripped conductor into the clamping unit until it hits backstop. Hold in this position.



A short counter-clockwise rotation ② releases the tab. When unlocked, the T-wrench rotates clockwise, securely clamping the conductor.

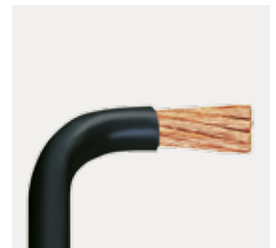

1. Bend conductor
2. Cut conductor to length (Conductor end must be straight!)
3. Strip conductor (Observe strip length printed on terminal block!)



Safe

Protective Warning Covers

- Clearly indicate high-voltage applications. Ex., Notice: Power is still on even after switching off the main switch!

Finger Guards

- Yellow, detachable covers shield the jumper slots and/or unused conductor entries, making them touch-proof.

Risk of Injury!

- Keep fingers out of the conductor entry hole!

Power Tap

(for 35 ... 185 mm²/2 AWG ... 350 kcmil)

- Provides safe and easy power distribution to additional loads.
- Insert the unwired tap before actuating the spring for termination.
- For 35 mm² (2 AWG) blocks, insert the power tap into the jumper slot in the middle of the terminal block.

Commoning



For 35 mm² (2 AWG)

Commoning adjacent terminal blocks using a centrally positioned push-in jumper. Use an operating tool to remove the conductor.



For 50, 95 (2/0, 4/0 AWG) and 185 mm² (350 kcmil)

Commoning with an adjacent jumper: insert the jumper above the conductor entry hole prior to conductor termination. The nominal cross-section remains unchanged.



Via Step-Down Jumpers with TOPJOB® S





















Commoning 35 mm² (2 AWG) high-current terminal blocks with 10/16 mm² (8/6 AWG) TOPJOB® S Rail-Mount Terminal Blocks.



Testing

Easy troubleshooting via 4 mm Ø touch-proof test plug. Use a test plug adapter (283-404) for 35 mm² (2 AWG) terminal blocks. (Test plugs are not available from WAGO, but are offered by suppliers, such as Multi-Contact Deutschland GmbH.)

285 SERIES

	35 mm ²				50 mm ²			
	2-conductor through terminal block		2-conductor ground terminal block		2-conductor through terminal block		2-conductor ground terminal block	
Conductor cross-section	6 ... 35 mm ²	10 ... 2 AWG	6 ... 35 mm ²	10 ... 2 AWG	10 ... 50 (70 "f-st") mm ²	8 ... 1/0 AWG	10 ... 50 (70 "f-st") mm ²	
Rated voltage	1000 V	880 V  , 600 V 			1000 V	880 V  , 600 V 		
Rated surge voltage	8 kV				8 kV			
Pollution degree	3		3		3		3	
Nominal current	I _N 125 A	115 A  , 115 A 			I _N 150 A	150 A  , 150 A 		
Terminal block width	16 mm	0.63 inch	16 mm	0.63 inch	20 mm	0.79 inch	20 mm	
Strip length	25 mm	0.98 inch	25 mm	0.98 inch	30 mm	1.18 inch	30 mm	
Image								
Item number	<ul style="list-style-type: none"> ● 285-135 ● 285-134 ● 285-131  ● 285-93 5   		285-137 285-137/999-950  		<ul style="list-style-type: none"> ● 285-150 ● 285-154 ● 285-151  ● 285-950   		285-157 285-157/999-	
Mounting	35 x 15 rail		35 x 15 rail; 2.3 mm thick		35 x 15 rail		35 x 15 rail; 2.3 mm thick copper	
Three phase set	285-139				285-159			
Accessories								
Adjacent jumper	285-435 (I _N 85 A)				285-450 (I _N 150 A for 1 jumper, I _N 130 A for 2 ... 4 jumpers)			
Step-down jumper	285-430 (I _N 90 A)				-			
Power tap	285-427 (800 V/8 kV/3; I _N 32 A)				285-447 (1000 V/8 kV/3; I _N 41 A)			
Warning cover	285-420				285-440			
Finger guard	285-421				285-441			
Tool	210-721 (type 3, 5.5 x 0.8 mm blade)				285-172			
Marking								
Marking strips	2009-110 (plain, white, 11 mm wide, 50 m reel)				2009-110 (plain, white, 11 mm wide, 50 m reel); only with marker carrier			
WMB Inline markers	2009-115 (plain, white, 1,500 markers, stretchable 5 ... 5.2 mm)				2009-115 (plain, white, 1,500 markers, stretchable 5 ... 5.2 mm)			
WMB Multi marking system	793-5501 (plain, white, 10 strips with 10 markers/card, stretchable 5 ... 5.2 mm)				793-5501 (plain, white, 10 strips with 10 markers/card, stretchable 5 ... 5.2 mm)			
Marker carrier	285-442				285-442			

 For more technical data, see our Full Line Catalog, Volume 1, or visit www.wago.com

 Version for functional ground in a gray-yellow housing – no contact with mounting frame

	95 mm ²				185 mm ²			
Terminal block	2-conductor through terminal block		2-conductor ground terminal block		2-conductor through terminal block		2-conductor ground terminal block	
8 ... 1/0 AWG	25 ... 95 mm ²	4 ... 4/0 AWG	25 ... 95 mm ²	4 ... 4/0 AWG	50 ... 185 mm ²	1/0 AWG ... 350 kcmil	50 ... 120 mm ²	1/0 AWG ... 250 kcmil
	1000 VAC/DC 1500 VDC	1000 V  , 1000 V 			1000 VAC/DC 1500 VDC	1000 V  , 1000 V 		
	8 kV				12 kV			
	3		3		3		3	
	I _N 232 A	200 A  , 210 A 			I _N 353 A	310 A  , 310 A 		
0.79 inch	25 mm	0.98 inch	25 mm	0.98 inch	32 mm	1.26 inch	32 mm	1.26 inch
1.18 inch	35 mm	1.38 inch	35 mm	1.38 inch	45 ... 47 mm	1.77 ... 1.85 inch	45 ... 47 mm	1.77 ... 1.85 inch
								
950  ①	<ul style="list-style-type: none"> ● 285-195 ● 285-194 ● 285-191 ② ● 285-995  ① 	<ul style="list-style-type: none"> ● 285-197 ● 285-197/999-950  ① 	<ul style="list-style-type: none"> ● 285-1185 ● 285-1184 ● 285-1181 ② ● 285-1189  ① 	<ul style="list-style-type: none"> ● 285-1187 ● 285-1187/999-950  ① 				
mm thick,	35 x 15 rail	35 x 15 rail; 2.3 mm thick, copper	35 x 15 rail	35 x 15 rail	35 x 15 rail	35 x 15 rail; 2.3 mm thick, copper	35 x 15 rail; 2.3 mm thick, copper	
	285-199				285-1169			
Jumpers)	285-495 (I _N 232 A for 1 jumper, I _N 192 A for 2 ... 4 jumpers)				285-1171 (I _N 309 A for 1 jumper)			
	-				-			
	285-407 (1000 V/8 kV/3; I _N 57 A)				285-1175 (1000 V/8 kV/3; I _N 57 A)			
	285-170				285-1177			
	285-169				285-1178			
	285-172				285-172			
5 ... 5.2 mm)	2009-110 (plain, white, 11 mm wide, 50 m reel); only with marker carrier				2009-110 (plain, white, 11 mm wide, 50 m reel)			
	2009-115 (plain, white, 1,500 markers, stretchable 5 ... 5.2 mm)				2009-115 (plain, white, 1,500 markers, stretchable 5 ... 5.2 mm)			
	793-5501 (plain, white, 10 strips with 10 markers/card, stretchable 5 ... 5.2 mm)				793-5501 (plain, white, 10 strips with 10 markers/card, stretchable 5 ... 5.2 mm)			
	285-442				-			



© WAGO

HIGH-CURRENT, RAIL-MOUNT TERMINAL BLOCKS WITH MOUNTING FLANGES

WAGO's 50, 95 and 185 mm² (2/0, 4/0 AWG and 350 kcmil) high-current terminal blocks are also available with mounting flanges for direct installation on a mounting plate.

These versions share the same accessories with the high-current, rail-mount terminal blocks.

285-1161

Nominal current: 353 A
Rated voltage:
up to 1,000 VAC/DC and
up to 1,500 VDC

Version for functional ground
in a gray-yellow housing – no
contact with mounting frame



Secure flange terminal block
directly to the mounting plate.

Vibration-Proof – Fast – Maintenance-Free

INSTALLATION

1



First, insert block-to-block connectors into housing slots.

2



Then, connect and align the terminal blocks.

3



Secure the terminal block to a mounting plate using two cylinder-head screws and appropriate washers.

285 SERIES WITH MOUNTING FLANGES

	50 mm ²		95 mm ²		185 mm ²	
	2-conductor through terminal block with mounting flanges		2-conductor through terminal block with mounting flanges		2-conductor through terminal block with mounting flanges	
Conductor cross-section	10 ... 50 (70 "f-st") mm ²	8 ... 1/0 AWG	25 ... 95 mm ²	4 ... 4/0 AWG	50 ... 185 mm ²	1/0 AWG ... 350 kcmil
Rated voltage	1000 V	880 V  , 600 V 	1000 VAC/DC 1500 VDC	1000 V  , 1000 V 	1000 VAC/DC 1500 VDC	1000V  , 1000 V 
Rated surge voltage	8 kV		8 kV		12 kV	
Pollution degree	3		3		3	
Nominal current	I _N 150 A	150 A  , 150 A 	I _N 232 A	200 A  , 210 A 	I _N 353 A	310 A  , 310 A 
Terminal block width	20 mm	0.79 inch	25 mm	0.98 inch	32 mm	1.26 inch
Strip length	30 mm	1.18 inch	35 mm	1.38 inch	45 ... 47 mm	1.77 ... 1.85 inch
						
Item number	<ul style="list-style-type: none"> ● 285-141 ● 285-144 ● 285-147 		<ul style="list-style-type: none"> ● 285-181 ● 285-184 ● 285-187 		<ul style="list-style-type: none"> ● 285-1161 ● 285-1164 ● 285-1167 	
Three phase set	285-148		285-188		285-1165	
Accessories						
Adjacent jumper	285-450 (I _N 150 A for 1 jumper, I _N 130 A for 2 ... 4 jumpers)		285-495 (I _N 232 A for 1 jumper, I _N 192 A for 2 ... 4 jumpers)		285-1171 (I _N 309 A for 1 jumper)	
Power tap	285-447 (1000 V/8 kV/3; I _N 41 A)		285-407 (1000 V/8 kV/3; I _N 57 A)		285-1175 (1000 V/8 kV/3; I _N 57 A)	
Block-to-block connector	285-448		285-168		285-1179	
Warning cover	285-440		285-170		285-1177	
Finger guard	285-441		285-169		285-1178	
Tool	285-172		285-172		285-172	
Marking						
Marking strips	2009-110 (plain, white, 11 mm wide, 50 m reel) 		2009-110 (plain, white, 11 mm wide, 50 m reel) 		2009-110 (plain, white, 11 mm wide, 50 m reel)	
WMB Inline markers	2009-115 (plain, white, 1,500 markers, stretchable 5 ... 5.2 mm)		2009-115 (plain, white, 1,500 markers, stretchable 5 ... 5.2 mm)		2009-115 (plain, white, 1,500 markers, stretchable 5 ... 5.2 mm)	
WMB Multi marking system	793-5501 (plain, white, 10 strips with 10 markers/card, stretchable 5 ... 5.2 mm)		793-5501 (plain, white, 10 strips with 10 markers/card, stretchable 5 ... 5.2 mm)		793-5501 (plain, white, 10 strips with 10 markers/card, stretchable 5 ... 5.2 mm)	
Marker carrier	285-442		285-442		-	

 Only with marker carrier

WAGO Kontakttechnik GmbH & Co. KG

Postfach 2880 · 32385 Minden
Hansastraße 27 · 32423 Minden
info@wago.com
www.wago.com

Headquarters	+49 571/ 887 - 0
Sales	+49 571/ 887 - 222
Orders	+49 571/ 887 - 44333
Fax	+49 571/ 887 - 8 44169

WAGO is a registered trademark of WAGO Verwaltungsgesellschaft mbH.

“Copyright – WAGO Kontakttechnik GmbH & Co. KG – All rights reserved. The content and structure of the WAGO websites, catalogs, videos and other WAGO media are subject to copyright. Distribution or modification to the contents of these pages and videos is prohibited. Furthermore, the content may neither be copied nor made available to third parties for commercial purposes. Also subject to copyright are the images and videos that were made available to WAGO Kontakttechnik GmbH & Co. KG by third parties.”